

TD-SILENT ECOWATT - MODELS 350 TO 1000



Low profile “Mixed-flow” fans with sound-absorbent insulation, extremely quiet, fan casing manufactured in plastic material, with a specially designed internal skin to direct the sound waves at the right angle for them to be captured by sound-absorbent material, fitted with flexible rubber seals on the inlet and outlet to absorb vibrations, with an external connection box, a body that can be removed without dismantling the adjacent ducting and therefore facilitating any installation or maintenance.

Brushless EC motor, high efficiency and low consumption, suitable for single phase supply 230V±15%/50-60Hz, IP44, thermal overload protection.

Fan speed 100% adjustable with the potentiometer placed in the connection box or with an external control type REB-ECOWATT. Analogue input with terminals in the terminal box to control the fan with 0-10V input signal. Models are suitable for mounting in any orientation and operation within ambient air temperatures between -20°C up to +40°C. Suitable for any kind of ventilation application where the noise level of the ventilation system is of particular importance and, due to continuous operation, a significant energy saving is desirable. It is also suitable for applications that require a Demand Controlled Ventilation System involving the use of other sensors or controls.

TD-SILENT ECOWATT - MODELS 1300 AND 2000



Low profile “Mixed-flow” fans with sound-absorbent insulation, extremely quiet, manufactured from heavy gauge sheet steel protected by a tough epoxy polyester paint coating, acoustic insulation (MO) glass fibre, outer shell and aerodynamic inlet to improve airflow and reduce sound.

A body that can be removed without dismantling the adjacent ducting and therefore facilitating any installation or maintenance. Brushless EC motor, high efficiency and low consumption, suitable for single phase supply 230V±15%/50-60Hz, IP44, thermal overload protection.

Fan speed 100% adjustable with the potentiometer placed in the connection box or with an external control type REB-ECOWATT. Analogue input with terminals in the terminal box to control the fan with 0-10V input signal. Models are suitable for mounting in any orientation and operation within ambient air temperatures between -20°C up to +40°C. Suitable for any kind of ventilation application where the noise level of the ventilation system is of particular importance and, due to continuous operation, a significant energy saving is desirable. It is also suitable for applications that require a Demand Controlled Ventilation System involving the use of other sensors or controls.

MODELS 350 TO 1000



Low profile

The low profile of the TD-SILENT ECOWATT fans makes them the most effective solution for installations where space is very limited, especially in ceiling voids.

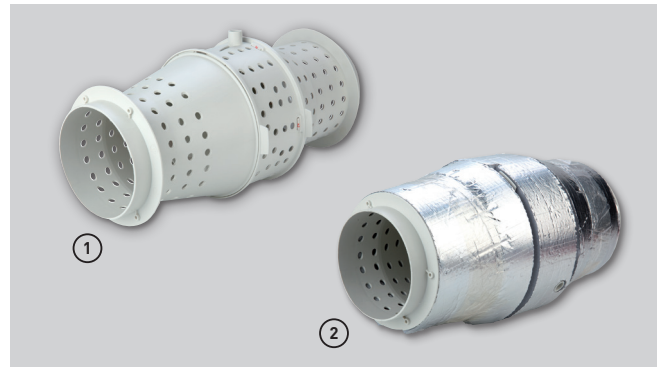

Low noise level

Sound waves produced inside the TD, are directed through the perforated inner skin ① and absorbed by the layer of sound absorbent material ②



Easy maintenance

Removable motor-body assembly to easy cleaning and repairing without touching the ducts. Support plastic brackets simplify the operation.

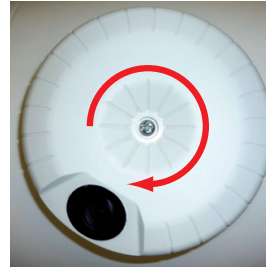

Connection box rotated 360°

Connection box can be rotated 360°, to facilitate easy connection of the power cable.



Rubber seals

Bi-material inlet and outlet incorporating a rubber seal to facilitate installation and absorb vibrations.



Support bracket

Support bracket for installing on a wall or ceiling, incorporating twin-material support brackets for the motor section that absorbs vibration.

Easy to mount

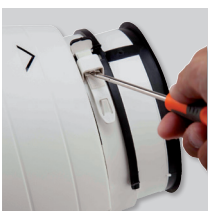

Loosen and open clamps on both sides.



Remove the fan body.



Remove the terminal box lid.



Connect electrical supply.



Remount the fan body by tightening the clamps.

MODELS 1300 AND 2000



Low profile - compact

Low profile fans TD-1300/250 SILENT ECOWATT and TD-2000/315 SILENT ECOWATT are ideal for installations where space is very limited, especially in ceiling voids.

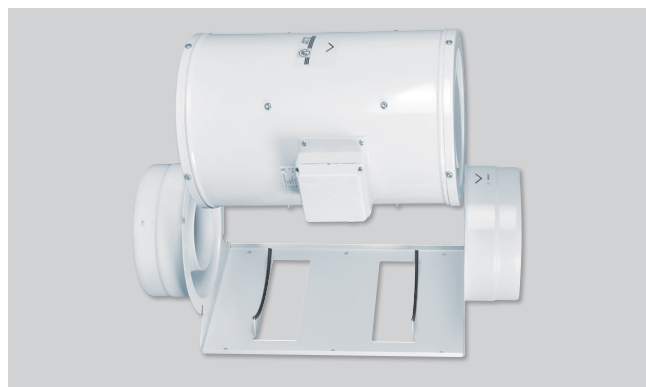

Easy maintenance

Detachable fan unit for maintenance, or cleaning, without demounting duct connections.

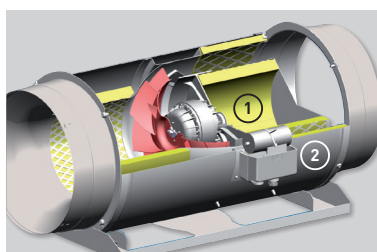

Low noise level

- ① Acoustic insulation (A2-s1, d0) glass fibre.
- ② Outer shell.
- ③ Aerodynamic inlet to improve air flow and reduce sound.
- ④ Attenuating perforated skin.



Support bracket

Suitable for wall or ceiling mounting. Fixing brackets to the motor-body included.



IP55 remote terminal box

Easy installation and connection.

TECHNICAL CHARACTERISTICS

Model	Input signal voltage (V)	Speed (rpm)	Maximum absorbed power (W)	Maximum absorbed current (A)	Airflow at free discharge (m ³ /h)	Sound pressure level* LpA at 3 m (dB(A))			Weight (kg)	Wiring diagram** (n°)
						Inlet	Outlet	Radiated		
TD-350/100-125 SILENT ECOWATT	10	2235	19	0,14	350	36	29	34	5,0	39
	8	2000	15	0,11	305	34	31	32		
	6	1580	10	0,07	240	28	26	28		
	4	1170	7	0,06	180	30	24	31		
TD-500/150-160 SILENT ECOWATT	10	2510	39	0,25	545	44	33	43	6,0	39
	8	2300	32	0,23	500	41	30	41		
	6	1800	18	0,13	390	36	26	35		
	4	1320	10	0,08	240	30	23	31		
TD-1000/200 SILENT ECOWATT	10	2470	99	0,66	1.000	46	34	53	8,7	39
	8	2120	64	0,46	860	42	31	48		
	6	1660	34	0,25	675	37	30	43		
	4	1220	17	0,12	485	30	25	34		
TD-1300/250 SILENT ECOWATT	10	2460	143	0,6	1.240	46	34	53	9,5	40
	8	2035	88	0,4	1.040	43	31	48		
	6	1645	54	0,3	810	38	30	43		
	4	1200	29	0,2	580	30	25	34		
TD-2000/315 SILENT ECOWATT	10	2520	247	1,0	1.660	52	41	57	14,0	40
	8	2075	146	0,6	1.380	47	35	52		
	6	1690	85	0,4	1.120	45	31	49		
	4	1230	41	0,2	790	44	31	46		

* Sound pressure level measured in free field condition at 3m, at the 2, 5, 8 and 11 working point of the performance curve.

** See section of Wiring Diagrams.

DIMENSIONS (mm)

TD-SILENT ECOWATT 350 to 1000

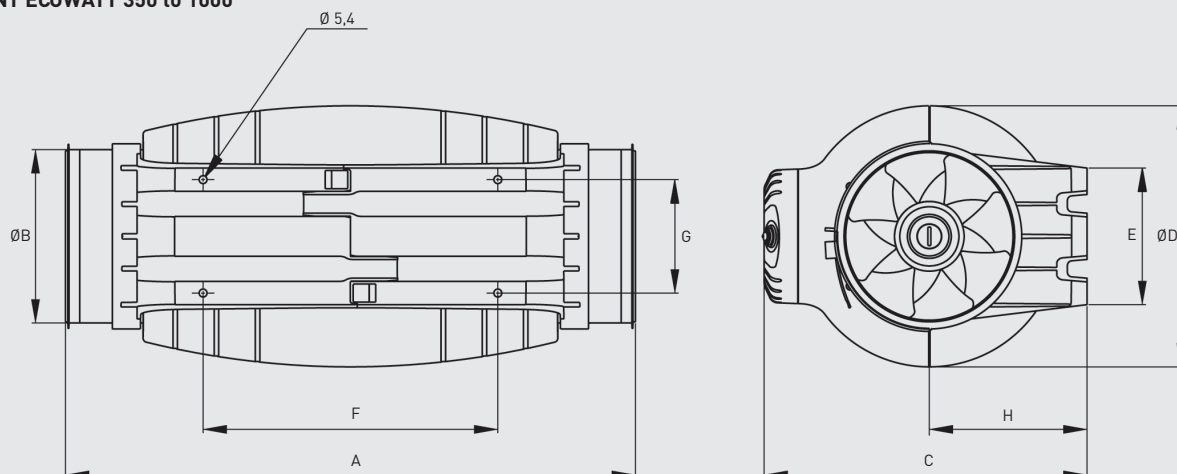

	A	ØB	C	ØD	E	F	G	H
TD-350/100	575	97	252	204	100	250	83	121
TD-350/125	462	123	252	204	100	250	83	121
TD-500/150-160*	484	147	274	221	116	250	96	134
TD-1000/200	568	198	327	264	145	340	129	164

* It provides an additional rubber gasket for installation in 160 mm ducts.

TD-SILENT ECOWATT 1300 to 2000

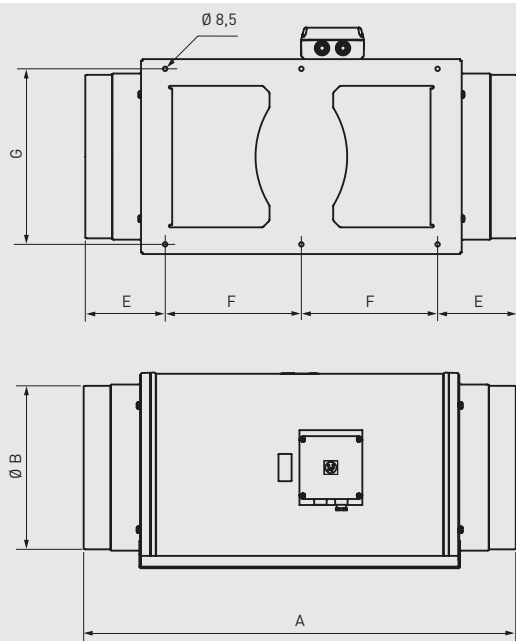

	A	B	C	D	E	F	G	H
TD-1300/250	680	248	331	387	140	200	280	171
TD-2000/315	825	312	373	432	152	260	335	192

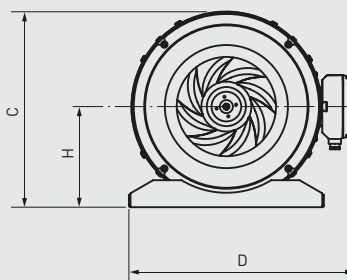

PERFORMANCE CURVES - ACOUSTIC CHARACTERISTICS

- q_v : Airflow in m^3/h .
- p_{sf} : Static pressure in Pa.
- P: Input power in W.
- SFP: Specific fan power in $W/m^3/s$ (blue curves).
- Performance data in accordance with ISO 5801 and AMCA 210-99 Standards.
- Sound power in dB(A).

TD-350/100-125 SILENT ECOWATT

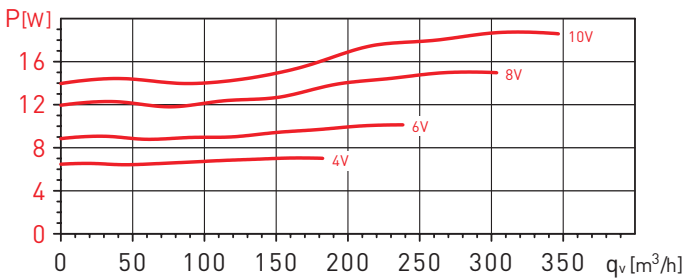
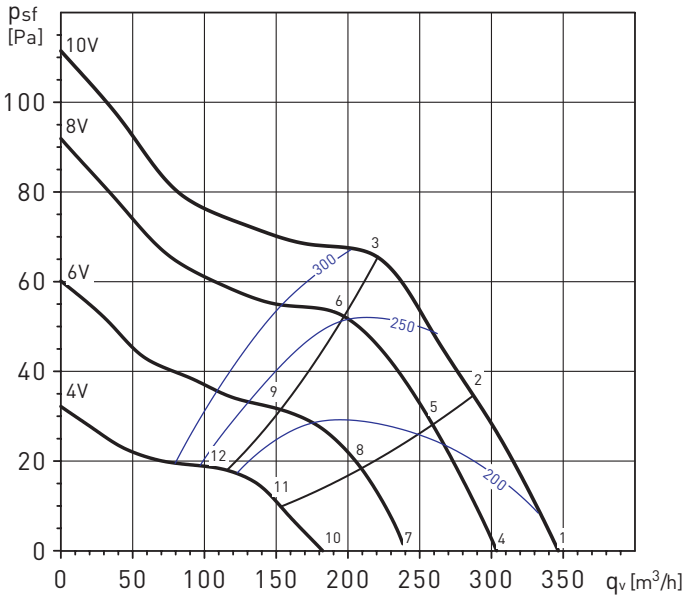

TD-350/100-125 SILENT ECOWATT		63	125	250	500	1.000	2.000	4.000	8.000	LwA
1	Inlet	19	26	42	54	50	44	37	30	56
	Outlet	33	31	41	52	50	44	37	29	55
	Radiated	17	25	38	48	42	35	28	19	50
2	Inlet	19	25	42	54	48	42	37	29	55
	Outlet	27	28	41	52	48	40	35	29	54
	Radiated	17	25	38	48	40	33	27	19	49
3	Inlet	25	31	41	53	48	45	39	32	55
	Outlet	25	32	41	51	47	41	38	31	53
	Radiated	23	30	38	47	40	36	29	21	49
4	Inlet	25	26	44	53	47	41	34	27	55
	Outlet	29	28	42	54	46	40	32	26	55
	Radiated	23	25	41	47	39	32	24	16	49
5	Inlet	22	25	44	53	45	39	34	26	54
	Outlet	23	27	42	54	44	37	32	26	54
	Radiated	20	24	41	47	37	30	24	16	48
6	Inlet	25	29	41	52	45	42	35	28	54
	Outlet	24	30	40	50	43	38	34	27	52
	Radiated	23	29	38	46	37	33	26	18	48
7	Inlet	23	24	44	45	41	33	28	24	49
	Outlet	27	28	47	42	40	31	26	24	49
	Radiated	20	24	44	41	34	23	21	22	46
8	Inlet	23	27	44	43	39	31	28	24	47
	Outlet	21	27	45	42	38	29	26	24	47
	Radiated	20	27	44	39	32	21	21	22	45
9	Inlet	22	27	43	42	40	35	29	24	47
	Outlet	22	28	44	41	38	30	27	24	47
	Radiated	20	27	43	38	33	25	22	22	44
10	Inlet	16	17	37	39	35	26	21	17	42
	Outlet	20	22	40	35	33	24	19	17	42
	Radiated	16	17	37	34	31	20	19	17	40
11	Inlet	16	21	37	36	33	24	22	17	41
	Outlet	14	21	38	35	31	22	19	17	41
	Radiated	16	21	37	32	29	18	20	17	39
12	Inlet	16	21	36	36	33	28	23	18	40
	Outlet	15	22	38	34	31	24	20	17	40
	Radiated	16	21	36	31	30	22	21	18	38

PERFORMANCE CURVES - ACOUSTIC CHARACTERISTICS

- q_v : Airflow in m^3/h .
- p_{sf} : Static pressure in Pa.
- P: Input power in W.
- SFP: Specific fan power in $W/m^3/s$ (blue curves).
- Performance data in accordance with ISO 5801 and AMCA 210-99 Standards.
- Sound power in dB(A).

TD-500/150-160 SILENT ECOWATT

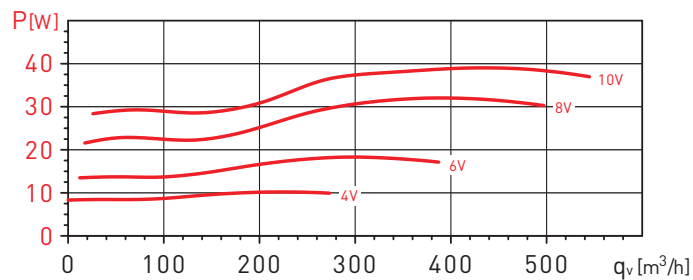
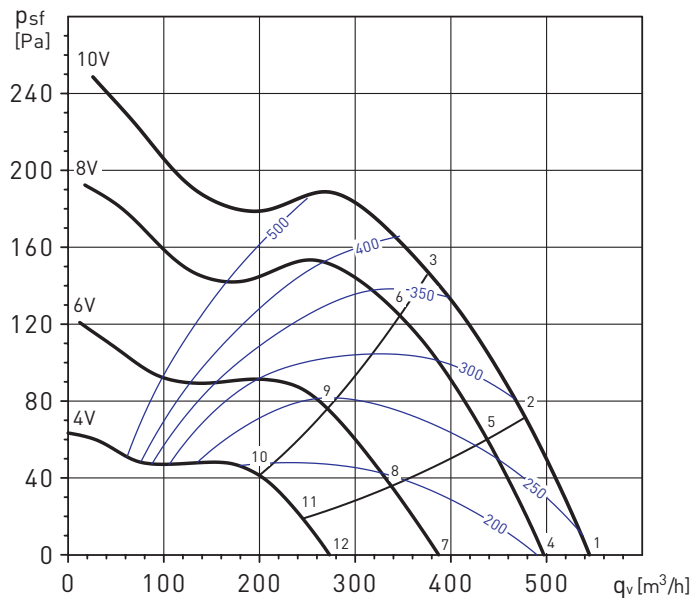

TD-500/150-160 SILENT ECOWATT	63	125	250	500	1.000	2.000	4.000	8.000	LwA
1 Inlet	22	33	52	60	60	60	54	45	65
1 Outlet	37	36	53	61	60	55	49	42	64
1 Radiated	10	27	45	50	49	46	41	31	54
2 Inlet	22	30	50	59	59	59	50	42	64
2 Outlet	35	33	52	60	59	52	45	38	63
2 Radiated	11	24	43	49	48	44	37	29	53
3 Inlet	21	29	51	59	57	55	49	43	63
3 Outlet	30	29	51	59	57	50	44	38	62
3 Radiated	10	23	45	49	47	41	36	29	53
4 Inlet	22	31	48	56	58	58	50	41	63
4 Outlet	33	33	50	57	58	53	46	38	62
4 Radiated	23	28	41	47	47	44	39	27	52
5 Inlet	24	28	47	54	56	57	47	38	61
5 Outlet	31	30	50	57	57	50	42	34	61
5 Radiated	25	25	39	46	45	43	36	25	50
6 Inlet	23	28	45	53	55	51	45	38	59
6 Outlet	25	28	49	54	54	46	40	33	58
6 Radiated	23	24	38	44	45	37	34	25	49
7 Inlet	26	28	43	51	54	55	42	32	58
7 Outlet	25	27	45	51	54	51	37	29	57
7 Radiated	14	22	37	42	45	40	29	20	48
8 Inlet	30	25	42	50	53	49	39	31	56
8 Outlet	25	26	44	50	52	42	33	27	55
8 Radiated	19	20	36	40	44	34	27	19	46
9 Inlet	32	29	41	49	51	43	37	29	54
9 Outlet	24	26	44	49	49	39	32	26	53
9 Radiated	20	24	36	40	43	28	24	17	45
10 Inlet	19	25	37	49	46	37	29	25	51
10 Outlet	19	25	37	49	46	37	29	25	51
10 Radiated	26	25	36	40	41	24	21	22	44
11 Inlet	20	25	37	49	44	34	28	25	50
11 Outlet	19	26	40	50	44	29	25	24	51
11 Radiated	27	26	36	39	39	21	20	22	43
12 Inlet	19	26	37	50	41	31	27	24	51
12 Outlet	21	26	40	50	44	28	24	24	51
12 Radiated	27	27	36	41	36	19	18	21	43

PERFORMANCE CURVES - ACOUSTIC CHARACTERISTICS

- q_v : Airflow in m^3/h .
- p_{sf} : Static pressure in Pa.
- P: Input power in W.
- SFP: Specific fan power in $W/m^3/s$ (blue curves).
- Performance data in accordance with ISO 5801 and AMCA 210-99 Standards.
- Sound power in dB(A).

TD-1000/200 SILENT ECOWATT

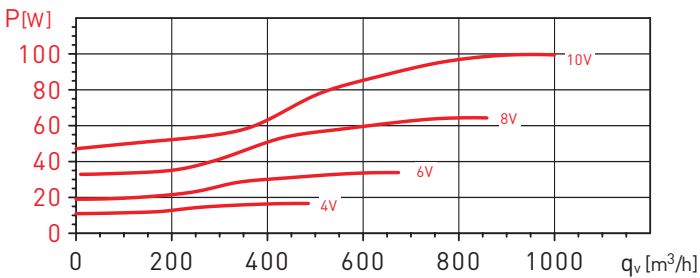
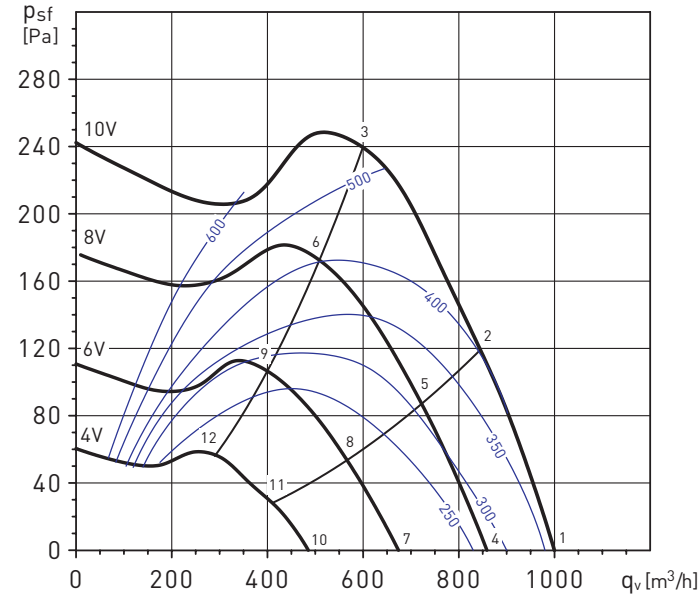

TD-1000/200 SILENT ECOWATT		63	125	250	500	1.000	2.000	4.000	8.000	LwA
1	Inlet	29	42	60	58	62	60	56	48	67
	Outlet	35	45	61	67	72	65	55	45	74
2	Radiated	21	29	43	48	51	47	39	36	55
	Inlet	30	43	58	58	61	59	54	48	66
3	Outlet	30	46	61	68	71	63	53	44	73
	Radiated	22	29	41	48	51	46	37	36	54
4	Inlet	36	48	60	59	58	57	52	44	65
	Outlet	33	52	64	67	68	61	51	41	71
5	Radiated	28	35	44	49	47	44	35	32	53
	Inlet	28	40	59	54	59	56	51	43	64
6	Outlet	29	42	60	62	67	59	49	39	69
	Radiated	22	25	40	39	50	44	38	35	52
7	Inlet	29	40	57	55	57	54	49	43	62
	Outlet	27	43	59	62	65	58	47	38	68
8	Radiated	23	25	39	40	48	42	36	35	51
	Inlet	34	45	57	56	54	53	48	40	62
9	Outlet	30	48	60	62	63	56	46	36	67
	Radiated	28	30	38	42	45	41	34	31	48
10	Inlet	26	36	52	52	55	49	44	36	58
	Outlet	27	39	60	57	60	54	43	33	64
11	Radiated	20	19	40	41	50	37	32	31	51
	Inlet	26	37	51	51	52	47	43	36	57
12	Outlet	28	40	57	57	58	52	41	33	63
	Radiated	21	20	40	41	48	36	31	31	50
1	Inlet	30	41	52	51	50	46	40	34	56
	Outlet	28	46	55	56	57	50	38	31	61
2	Radiated	25	24	40	40	46	34	28	29	48
	Inlet	23	34	45	47	45	40	34	30	51
3	Outlet	24	41	48	50	50	44	33	29	55
	Radiated	14	22	37	44	42	32	30	29	47
4	Inlet	24	34	45	45	44	39	34	30	50
	Outlet	33	40	48	49	49	43	33	29	54
5	Radiated	14	22	37	41	40	31	30	29	45
	Inlet	26	37	45	43	43	37	32	30	49
6	Outlet	26	41	48	47	48	41	31	29	53
	Radiated	17	25	36	39	39	29	27	29	44

PERFORMANCE CURVES - ACOUSTIC CHARACTERISTICS

- q_v : Airflow in m^3/h .
- p_{sf} : Static pressure in Pa.
- P: Input power in W.
- SFP: Specific fan power in $W/m^3/s$ (blue curves).
- Performance data in accordance with ISO 5801 and AMCA 210-99 Standards.
- Sound power in dB(A).

TD-1300/250 SILENT ECOWATT

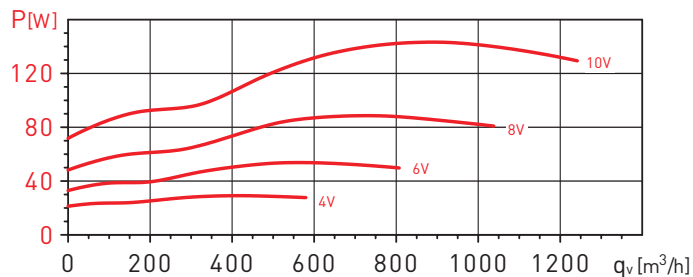
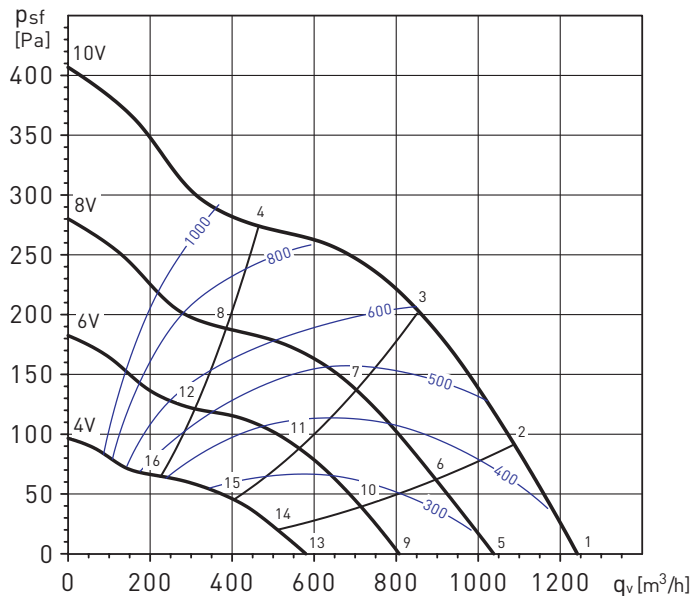

TD-1300/250 SILENT ECOWATT		63	125	250	500	1.000	2.000	4.000	8.000	LwA
1	Inlet	29	42	60	58	62	60	56	48	67
	Outlet	35	45	61	67	72	65	55	45	74
	Radiated	21	29	43	48	51	47	39	36	55
2	Inlet	30	42	58	58	62	59	55	48	66
	Outlet	32	45	61	67	71	64	54	45	73
	Radiated	22	29	42	48	51	46	38	36	54
3	Inlet	33	45	59	58	59	58	53	46	65
	Outlet	32	49	62	67	69	62	52	43	72
	Radiated	25	32	43	49	49	45	36	34	53
4	Inlet	36	48	60	59	58	57	52	44	65
	Outlet	33	52	64	67	68	61	51	41	71
	Radiated	28	35	44	49	47	44	35	32	53
5	Inlet	28	40	59	54	59	56	51	43	64
	Outlet	29	42	60	62	67	59	49	39	69
	Radiated	22	25	40	39	50	44	38	35	52
6	Inlet	28	40	58	55	58	54	50	43	63
	Outlet	28	43	60	62	66	58	48	38	69
	Radiated	23	25	39	40	49	43	37	35	51
7	Inlet	31	43	57	56	56	53	49	41	62
	Outlet	29	46	60	63	64	57	47	37	68
	Radiated	26	28	39	42	47	41	35	33	49
8	Inlet	34	45	56	56	53	52	47	39	61
	Outlet	30	48	59	62	62	56	45	35	66
	Radiated	28	30	38	41	44	40	34	31	48
9	Inlet	26	36	52	52	55	49	44	36	58
	Outlet	27	39	60	57	60	54	43	33	64
	Radiated	20	19	40	41	50	37	32	31	51
10	Inlet	26	37	52	52	53	48	44	36	58
	Outlet	27	40	58	57	59	53	42	33	63
	Radiated	21	20	40	41	49	36	31	31	50
11	Inlet	29	40	52	52	52	48	43	36	58
	Outlet	28	43	57	57	58	52	41	32	63
	Radiated	23	23	40	41	47	36	30	30	49
12	Inlet	31	42	52	51	50	46	40	33	56
	Outlet	28	47	55	56	56	50	38	31	61
	Radiated	26	25	40	40	46	34	28	28	48
13	Inlet	23	34	45	47	45	40	34	30	51
	Outlet	24	41	48	50	50	44	33	29	55
	Radiated	14	22	37	44	42	32	30	29	47
14	Inlet	24	34	45	45	44	39	34	30	50
	Outlet	30	41	48	49	49	43	33	29	54
	Radiated	14	22	37	42	40	31	30	29	45
15	Inlet	25	35	45	44	43	38	34	30	50
	Outlet	30	40	48	49	49	42	32	29	54
	Radiated	16	23	37	40	40	30	29	29	44
16	Inlet	26	37	44	43	42	36	32	30	49
	Outlet	26	41	47	47	47	40	30	29	52
	Radiated	16	25	36	39	38	29	27	29	43

PERFORMANCE CURVES - ACOUSTIC CHARACTERISTICS

- q_v : Airflow in m^3/h .
- p_{sf} : Static pressure in Pa.
- P: Input power in W.
- SFP: Specific fan power in $W/m^3/s$ (blue curves).
- Performance data in accordance with ISO 5801 and AMCA 210-99 Standards.
- Sound power in dB(A).

TD-2000/315 SILENT ECOWATT

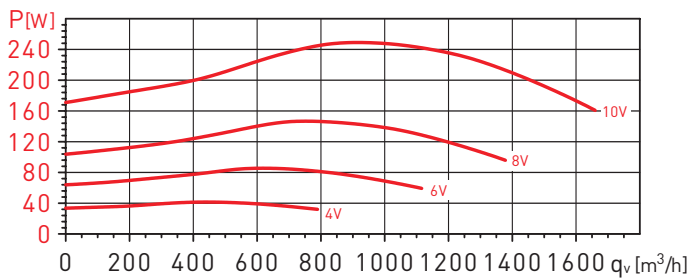
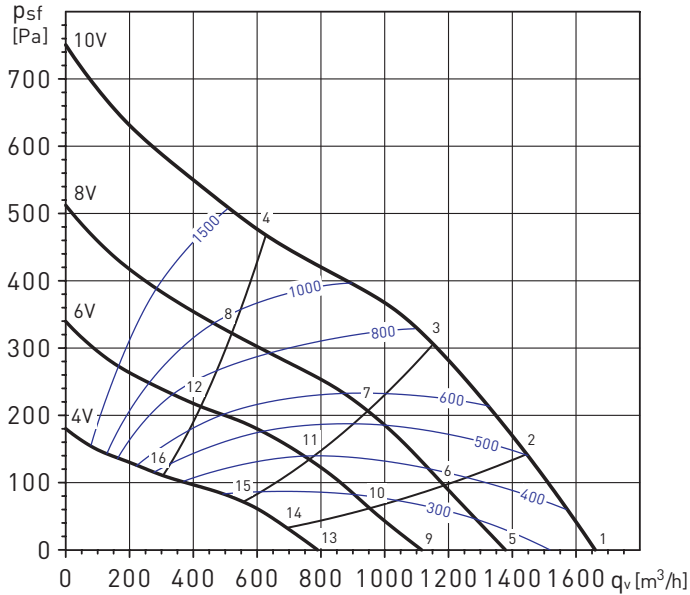

TD-2000/315 SILENT ECOWATT		63	125	250	500	1,000	2,000	4,000	8,000	LwA
1	Inlet	35	50	64	63	68	64	57	52	71
	Outlet	37	54	64	70	74	66	52	48	76
	Radiated	22	37	48	48	57	54	45	39	60
2	Inlet	35	51	66	64	68	64	58	52	72
	Outlet	35	55	65	71	74	66	51	48	77
	Radiated	22	38	51	49	58	54	46	39	61
3	Inlet	37	54	71	64	68	64	58	52	74
	Outlet	35	59	70	72	72	65	50	47	77
	Radiated	24	42	56	49	58	54	46	39	61
4	Inlet	44	59	67	63	64	60	55	49	71
	Outlet	40	65	66	70	69	61	49	47	74
	Radiated	32	46	52	48	53	51	43	36	58
5	Inlet	32	47	61	59	63	58	52	44	67
	Outlet	31	51	60	65	70	60	46	41	72
	Radiated	21	34	42	45	52	48	40	32	55
6	Inlet	33	50	63	59	63	58	53	45	63
	Outlet	30	54	62	66	69	60	45	41	69
	Radiated	21	36	44	45	52	48	41	33	51
7	Inlet	34	60	63	59	63	58	53	45	62
	Outlet	32	62	64	67	67	59	44	40	68
	Radiated	23	46	45	45	52	48	40	33	49
8	Inlet	40	54	63	55	58	54	49	42	65
	Outlet	36	60	62	64	63	56	43	41	69
	Radiated	28	40	44	41	47	44	37	29	51
9	Inlet	30	45	57	55	58	53	46	37	62
	Outlet	28	49	58	61	65	54	39	34	67
	Radiated	22	33	40	42	47	42	34	26	50
10	Inlet	31	47	59	56	58	54	48	39	58
	Outlet	27	51	58	62	64	54	39	35	63
	Radiated	23	35	42	42	47	43	35	28	50
11	Inlet	32	52	60	55	58	53	47	39	58
	Outlet	30	58	57	62	61	54	38	34	63
	Radiated	24	40	43	42	47	43	35	28	49
12	Inlet	39	50	57	51	53	50	44	36	60
	Outlet	35	54	56	59	58	51	38	35	63
	Radiated	31	38	40	37	42	39	31	24	47
13	Inlet	28	41	50	49	48	45	36	30	55
	Outlet	26	46	48	54	52	45	32	30	58
	Radiated	20	28	35	39	38	35	28	26	43
14	Inlet	29	44	52	49	49	45	37	30	50
	Outlet	26	47	50	54	52	45	32	30	54
	Radiated	21	30	37	38	38	35	29	27	45
15	Inlet	33	47	52	48	50	45	37	31	50
	Outlet	28	49	52	54	52	45	32	30	54
	Radiated	24	33	38	37	39	35	29	27	44
16	Inlet	37	43	48	46	45	43	35	30	53
	Outlet	32	47	48	51	49	42	32	30	55
	Radiated	28	29	34	35	34	33	27	26	41

ELECTRICAL ACCESSORIES



REB-ECOWATT
Remote speed control.
 Enables the speed control of the fan continuously, manually and remote.



CONTROL ECOWATT AC/DC
Control element for demand controlled ventilation systems in public, commercial residential buildings it automatically modifies the fan speed to adapt it to the needs defined in the system, measured with sensors.



SCO2-A
Ambient CO₂ and temperature sensor.

SCO2-AD
Ambient CO₂ and temperature sensor with display.

SCHT-AD
Ambient CO₂ sensor, temperature and relative humidity with display.



CPTA-S/CPTA-E
 Presence detector.



TDP-S/TDP-D/TDP-PI
Pressure sensor
 Used to control the pressure in ventilation systems under constant pressure or constant flow. They can read a difference in pressure between two points, transforming it into an electric signal for the different types of control.



REMP
Motorised damper, opens proportionately and is controlled by the BEAS control module. Power supply: 24 VAC or 24 VD, depending on the models.



AIRSENS
 Single-phase speed controller.