



Range of in-line fans for circular ducts, designed for high aerodynamic performances with a very compact profiles and very low sound levels. The range comprises seven diameters and covers a flow range from 260 to 1610 m³/h.

Low profile compact casing manufactured from galvanised sheet steel. The terminal box and the mounting bracket do not increase the product's profile. Optimised design of the impeller, guide vane and outlet diffuser, manufactured from injection-moulded plastic, to increase performance and lower the sound level.

Airtight joint between the galvanised steel casing and the plastic guide vane to avoid air leaks. Rubber gaskets on the flanges to improve airtightness with the ducts. Silent-block between the motor and the holder to reduce the motor's vibrations and lower the sound level of the installation, even in terms of speed regulation.

The whole product is rated IP44 but its terminal box is rated IP65 allowing outdoor installation.

Motor

- External rotor single-phase AC motor:
- 220-240V 50/60Hz*, Class F, IP44
 - Speed controllable by voltage.
 - Thermal protection with manual reset.
 - Working temperature: -20/60 °C
- *JETLINE-315: 220-240V50Hz.

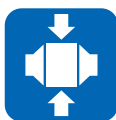

DESIGNED FOR AN EASY INSTALLATION



Terminal box
 Built-in, IP65 terminal box that does not add to the overall height dimensions.



Airtight joints
 Rubber gaskets for a more airtight joint with the installation's ducts.



High performance Impeller
 New impeller geometry for reduced sound levels and to offer high performance.

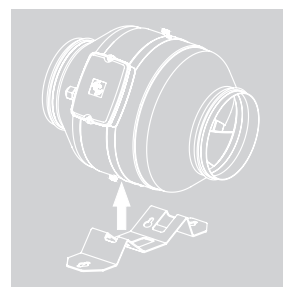

Mounting bracket
 Strong mounting bracket supplied with the fan.

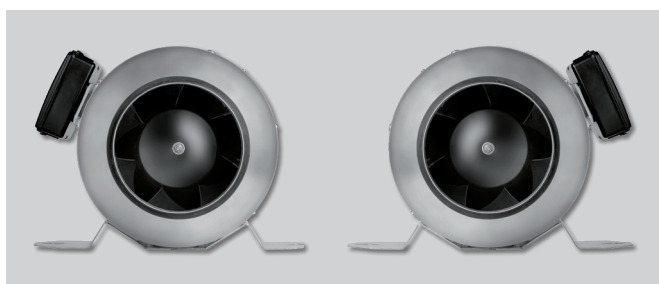

Two mounting positions for support

The product can be mounted in two different positions by changing the position of the support's anchoring.

TECHNICAL CHARACTERISTICS

Before installation check that the product electrical characteristics listed on the data plate label (voltage, power, frequency, etc.) match those of the intended electrical supply.

Model type	Average speed (rpm)	Maximum absorbed power (W)	Maximum absorbed current (A-230V)	Maximum air volume (m ³ /h)	Sound pressure level* (dB(A))			Max. Air temp. (°C at 50Hz)	Weight (kg)	Speed controller	
					Inlet	Radiated	Outlet			REB	RMB
JETLINE-100	2650	16	0,10	267	40	22	39	-20/+60	3	REB-1 N	RMB-1,5
JETLINE-125	2680	38	0,18	411	47	25	47	-20/+60	3,4	REB-1 N	RMB-1,5
JETLINE-150	2720	75	0,40	717	52	31	50	-20/+60	4,5	REB-1 N	RMB-1,5
JETLINE-160	2720	79	0,40	750	52	31	51	-20/+60	4,5	REB-1 N	RMB-1,5
JETLINE-200	2620	117	0,55	1040	57	40	54	-20/+60	5,6	REB-1 N	RMB-1,5
JETLINE-250	2715	160	0,67	1279	59	45	58	-20/+60	6,5	REB-1 N	RMB-1,5
JETLINE-315	2595	215	0,89	1610	59	49	60	-20/+60	8,4	REB-1 N	RMB-1,5

* sound pressure level measured at 1,5 m in free field condition, at the duty point 2 of the performance curve.

DIMENSIONS (mm)

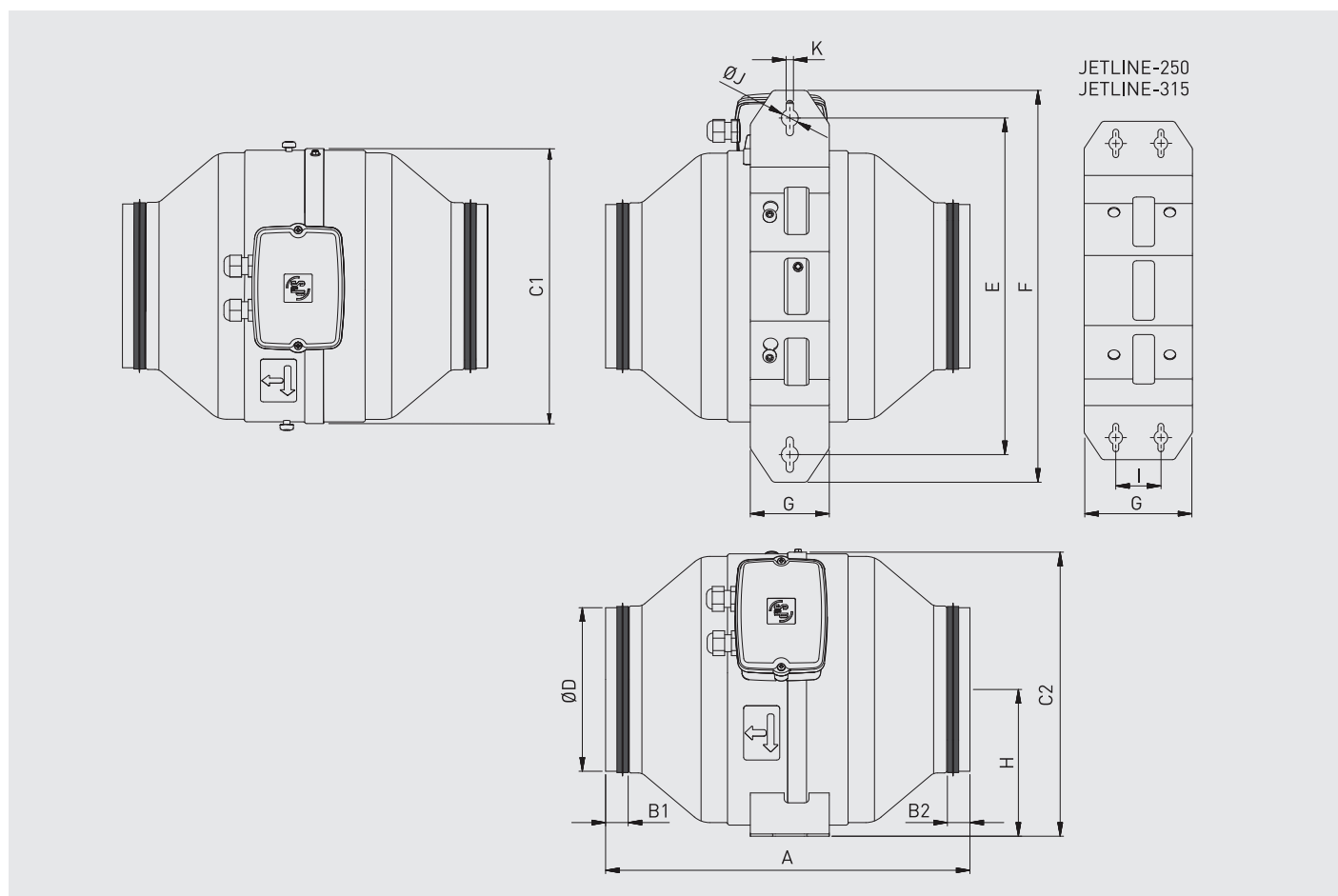

Model	A	B1	B2	C1	C2	ØD	E	F	G	H	I	ØJ	K	kg
JETLINE-100	276	15	15	181	190	95	256	306	70	98	-	15	6,5	3
JETLINE-125	279	15	15	206	214	120	265	315	70	111	-	15	6,5	3,4
JETLINE-150	323	20	20	243,5	252	145	298,5	348	70	130	-	15	6,5	4,5
JETLINE-160	323	20	20	243,5	252	155	298,5	348	70	130	-	15	6,5	4,5
JETLINE-200	322	30	30	273	281	195	320	369	100	144,5	-	15	6,5	5,6
JETLINE-250	329	20	30	293	301	245	326	375	120	154,3	50	15	6,5	6,5
JETLINE-315	369	20	33	322	331	310	357,5	407	120	170	50	15	6,5	8,9

PERFORMANCE CURVES - ACOUSTIC CHARACTERISTICS

- q_v : Airflow in m^3/h .
- p_{sf} : Static pressure in Pa.
- P: Input power in W.
- SFP: Specific fan power in $W/m^3/s$ (blue curves).
- Performance data in accordance with ISO 5801.

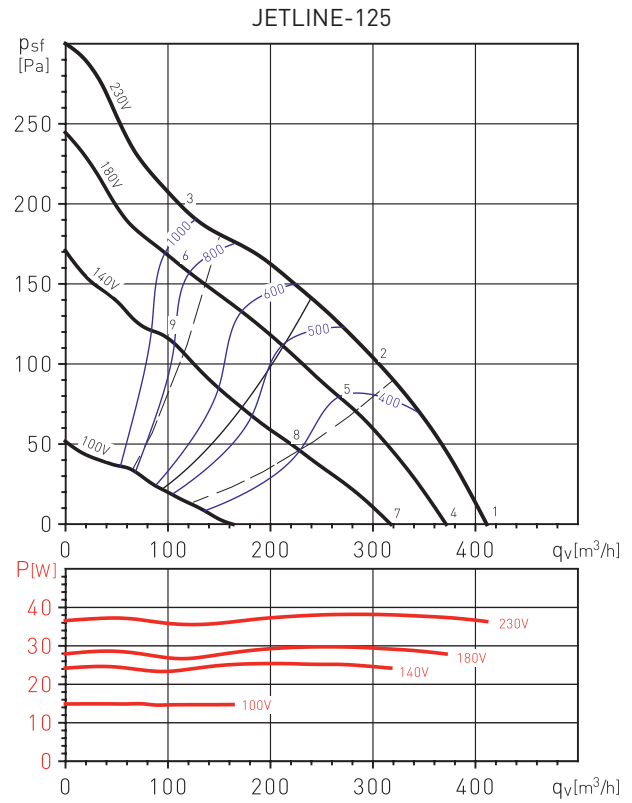
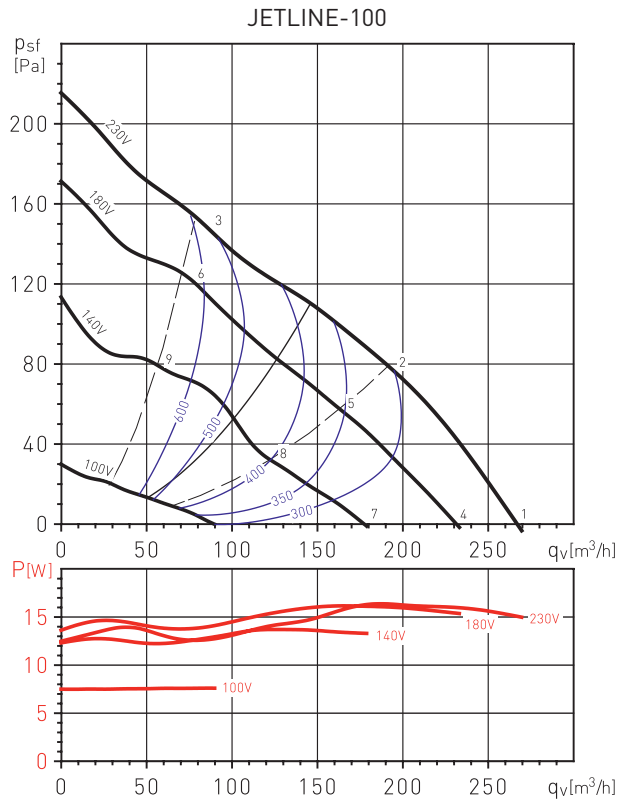

Sound power spectrum (dB(A))

Working point		63	125	250	500	1000	2000	4000	8000	LwA
1	INLET	30	33	44	50	54	51	51	36	58
	OUTLET	27	32	45	49	50	49	46	34	55
	BREAK-OUT	20	20	23	27	35	34	34	20	39
2	INLET	27	31	42	47	51	48	48	34	55
	OUTLET	27	32	44	47	48	46	46	34	53
	BREAK-OUT	20	20	21	24	32	31	31	20	36
3	INLET	29	39	51	52	56	51	50	36	59
	OUTLET	29	41	53	51	53	49	47	35	58
	BREAK-OUT	20	21	30	29	37	34	33	20	40
4	INLET	27	30	41	47	51	48	48	33	55
	OUTLET	24	29	42	46	47	46	43	31	52
	BREAK-OUT	20	20	20	24	32	31	31	20	37
5	INLET	23	27	38	43	47	44	44	30	51
	OUTLET	23	28	40	43	44	42	42	30	50
	BREAK-OUT	20	20	20	20	28	27	27	20	34
6	INLET	27	37	49	50	54	49	48	34	57
	OUTLET	27	39	51	49	51	47	45	33	56
	BREAK-OUT	20	20	28	27	35	32	31	20	38
7	INLET	22	25	36	42	46	43	43	28	50
	OUTLET	19	24	37	41	42	41	38	26	47
	BREAK-OUT	20	20	20	20	27	26	26	20	32
8	INLET	17	21	32	37	41	38	38	24	45
	OUTLET	17	22	34	37	38	36	36	24	44
	BREAK-OUT	20	20	20	20	22	21	21	20	30
9	INLET	22	32	44	45	49	44	43	29	53
	OUTLET	22	34	46	44	46	42	40	28	51
	BREAK-OUT	20	20	23	22	30	27	26	20	34

Sound power spectrum (dB(A))

Working point		63	125	250	500	1000	2000	4000	8000	LwA
1	INLET	41	38	52	63	55	56	52	43	65
	OUTLET	29	45	52	61	56	56	54	41	64
	BREAK-OUT	31	25	27	37	34	35	33	25	42
2	INLET	40	37	50	58	52	54	51	41	61
	OUTLET	28	47	48	58	54	54	54	39	62
	BREAK-OUT	30	24	25	32	31	33	32	23	39
3	INLET	43	46	59	63	57	56	53	42	66
	OUTLET	31	52	53	61	58	56	57	40	65
	BREAK-OUT	33	33	34	37	36	35	34	24	43
4	INLET	39	36	50	61	53	54	50	41	63
	OUTLET	27	43	50	59	54	54	52	39	62
	BREAK-OUT	29	23	25	35	32	33	31	23	40
5	INLET	37	34	47	55	49	51	48	38	59
	OUTLET	25	44	45	55	51	51	51	36	59
	BREAK-OUT	27	21	22	29	28	30	29	20	37
6	INLET	41	44	57	61	55	54	51	40	64
	OUTLET	29	50	51	59	56	54	55	38	63
	BREAK-OUT	31	31	32	35	34	33	32	22	41
7	INLET	35	32	46	57	49	50	46	37	59
	OUTLET	23	39	46	55	50	50	48	35	58
	BREAK-OUT	25	20	21	31	28	29	27	20	36
8	INLET	33	30	43	51	45	47	44	34	54
	OUTLET	21	40	41	51	47	47	47	32	54
	BREAK-OUT	23	20	20	25	24	26	25	20	32
9	INLET	37	40	53	57	51	50	47	36	60
	OUTLET	25	46	47	55	52	50	51	34	59
	BREAK-OUT	27	27	28	31	30	29	28	20	38

PERFORMANCE CURVES - ACOUSTIC CHARACTERISTICS

- q_v : Airflow in m^3/h .
- p_{sf} : Static pressure in Pa.
- P: Input power in W.
- SFP: Specific fan power in $W/m^3/s$ (blue curves).
- Performance data in accordance with ISO 5801.

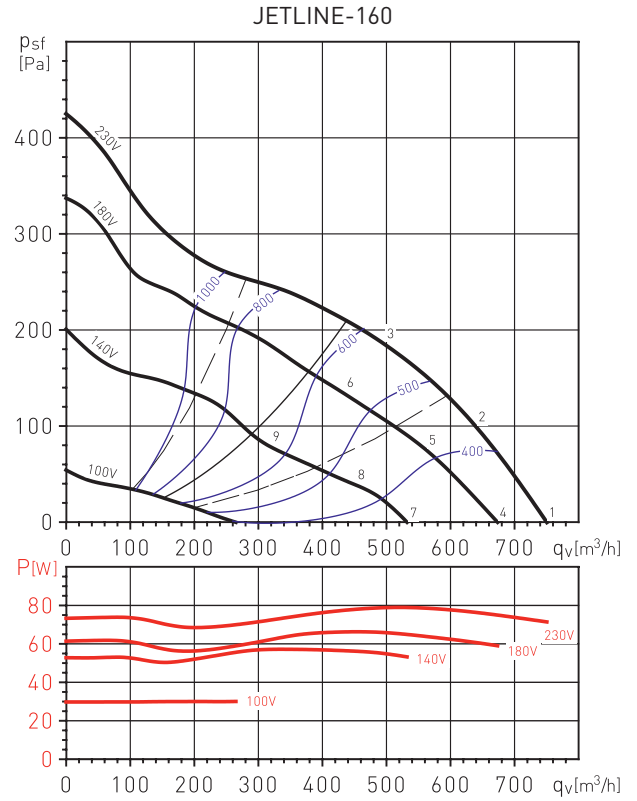
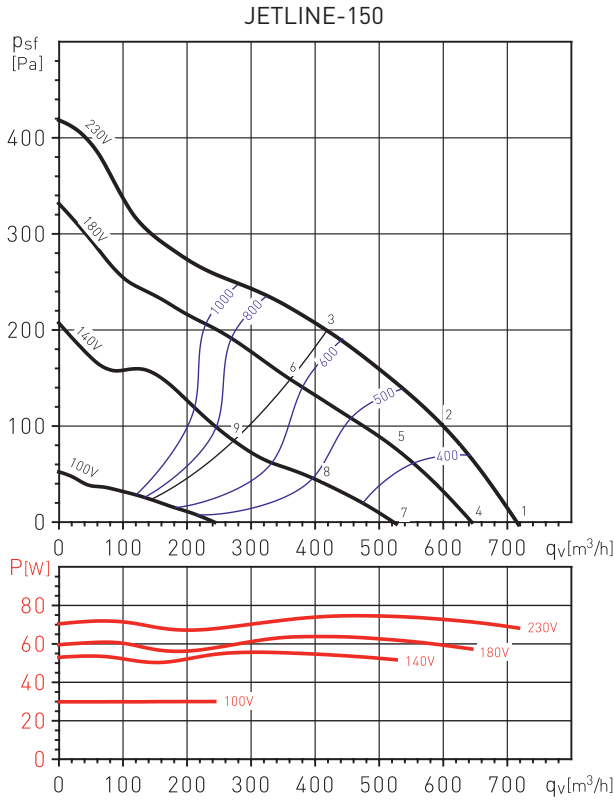

Sound power spectrum (dB(A))

Working point	63	125	250	500	1000	2000	4000	8000	LwA
1	INLET	29	40	58	62	59	61	59	67
	OUTLET	40	43	57	62	59	59	57	66
	BREAK-OUT	20	27	34	39	39	41	42	47
2	INLET	28	39	58	62	58	60	57	66
	OUTLET	28	43	56	61	57	58	55	65
	BREAK-OUT	20	26	34	39	38	40	40	46
3	INLET	34	43	53	61	57	60	55	65
	OUTLET	31	46	55	61	57	58	53	65
	BREAK-OUT	20	30	29	38	37	40	38	45
4	INLET	26	37	55	59	56	58	56	65
	OUTLET	38	41	55	60	57	57	55	64
	BREAK-OUT	20	24	31	36	36	38	39	44
5	INLET	25	36	55	59	55	57	54	64
	OUTLET	25	40	53	58	54	55	52	62
	BREAK-OUT	20	23	31	36	35	37	37	43
6	INLET	31	40	50	58	54	57	52	62
	OUTLET	28	43	52	58	54	55	50	61
	BREAK-OUT	20	27	26	35	34	37	35	41
7	INLET	21	32	50	54	51	53	51	59
	OUTLET	32	35	49	54	51	51	49	59
	BREAK-OUT	20	20	26	31	31	33	34	39
8	INLET	19	30	49	53	49	51	48	58
	OUTLET	19	34	47	52	48	49	46	56
	BREAK-OUT	20	20	25	30	29	31	31	37
9	INLET	24	33	43	51	47	50	45	56
	OUTLET	21	36	45	51	47	48	43	55
	BREAK-OUT	20	20	20	28	27	30	28	35

Sound power spectrum (dB(A))

Working point	63	125	250	500	1000	2000	4000	8000	LwA
1	INLET	38	49	54	63	60	62	64	69
	OUTLET	39	42	56	63	59	59	60	67
	BREAK-OUT	24	20	23	35	38	40	47	49
2	INLET	36	47	54	62	58	60	60	67
	OUTLET	44	42	55	62	58	58	57	66
	BREAK-OUT	22	20	23	34	36	38	43	46
3	INLET	38	45	54	61	56	60	57	65
	OUTLET	45	46	55	61	57	58	55	65
	BREAK-OUT	24	20	23	33	34	38	40	44
4	INLET	36	47	52	61	58	60	62	66
	OUTLET	37	40	54	61	57	57	58	65
	BREAK-OUT	22	20	21	33	36	38	45	46
5	INLET	33	44	51	59	55	57	57	64
	OUTLET	41	39	52	59	55	55	54	63
	BREAK-OUT	20	20	20	31	33	35	40	43
6	INLET	35	42	51	58	53	57	54	62
	OUTLET	42	43	52	58	54	55	52	62
	BREAK-OUT	21	20	20	30	31	35	37	40
7	INLET	30	41	46	55	52	54	56	61
	OUTLET	31	34	48	55	51	51	52	60
	BREAK-OUT	20	20	20	27	30	32	39	41
8	INLET	27	38	45	53	49	51	51	58
	OUTLET	35	33	46	53	49	49	48	57
	BREAK-OUT	20	20	20	25	27	29	34	37
9	INLET	29	36	45	52	47	51	48	56
	OUTLET	36	37	46	52	48	49	46	56
	BREAK-OUT	20	20	20	24	25	29	31	35

PERFORMANCE CURVES - ACOUSTIC CHARACTERISTICS

- q_v : Airflow in m^3/h .
- p_{sf} : Static pressure in Pa.
- P: Input power in W.
- SFP: Specific fan power in $W/m^3/s$ (blue curves).
- Performance data in accordance with ISO 5801.

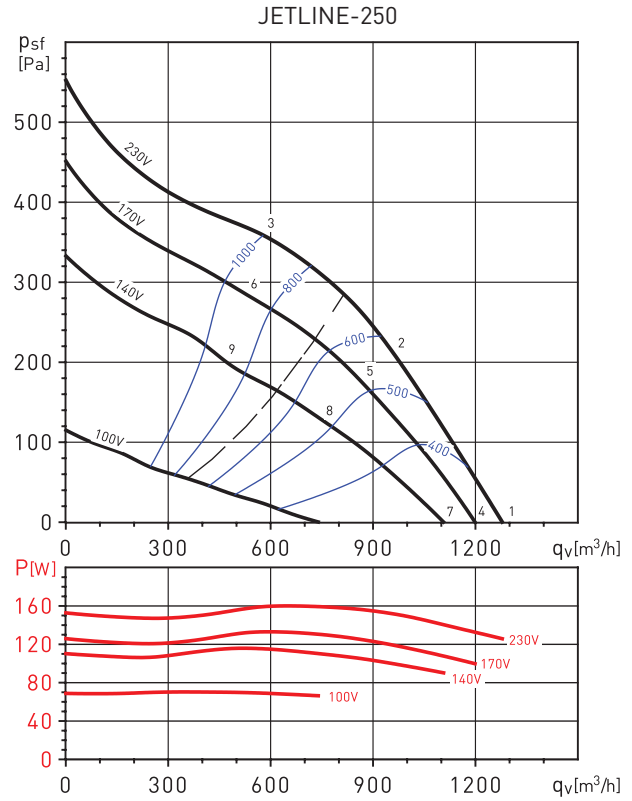
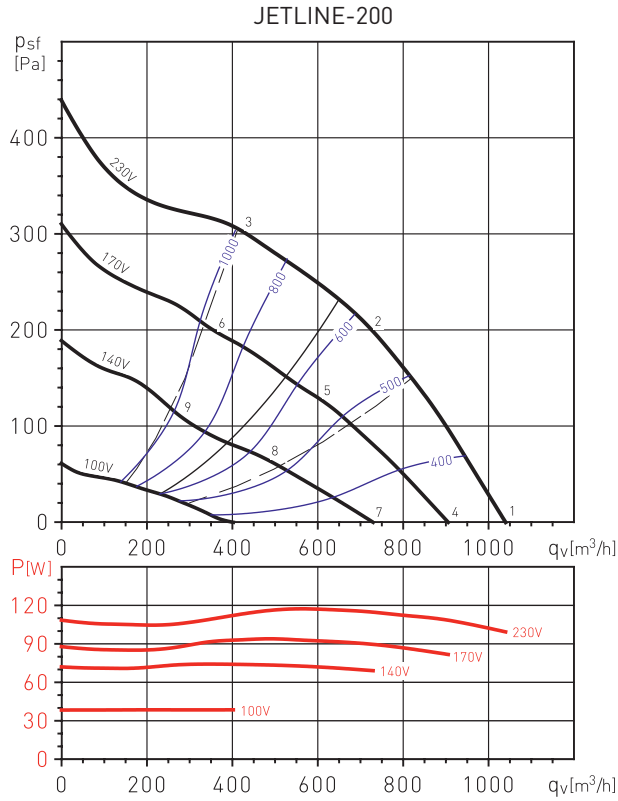

Sound power spectrum (dB(A))

Working point		63	125	250	500	1000	2000	4000	8000	LwA
1	INLET	29	42	59	63	65	64	67	62	72
	OUTLET	38	43	60	64	64	63	62	57	70
	BREAK-OUT	20	31	41	47	49	46	51	46	56
2	INLET	28	39	55	65	67	64	63	56	71
	OUTLET	28	44	55	63	64	63	58	51	69
	BREAK-OUT	20	28	37	48	51	46	47	40	55
3	INLET	40	49	61	66	69	67	60	52	73
	OUTLET	38	53	61	65	66	67	58	50	72
	BREAK-OUT	23	38	44	50	53	49	44	36	56
4	INLET	26	39	56	60	62	61	64	59	69
	OUTLET	35	40	57	61	61	60	59	54	67
	BREAK-OUT	20	28	38	44	46	43	48	43	53
5	INLET	24	34	50	60	63	60	58	51	67
	OUTLET	24	39	51	59	59	58	53	47	64
	BREAK-OUT	20	24	33	44	47	42	42	35	50
6	INLET	35	44	56	62	64	62	56	48	68
	OUTLET	33	49	57	61	62	62	53	45	67
	BREAK-OUT	20	33	39	45	48	44	40	32	52
7	INLET	21	33	50	55	57	56	59	53	63
	OUTLET	29	35	52	55	56	55	54	49	62
	BREAK-OUT	20	22	33	38	41	38	43	37	47
8	INLET	18	28	44	54	56	53	52	45	60
	OUTLET	17	33	44	53	53	52	47	40	58
	BREAK-OUT	20	20	27	37	40	36	36	29	44
9	INLET	29	38	50	55	58	56	49	41	62
	OUTLET	27	42	50	54	55	56	47	39	61
	BREAK-OUT	20	27	33	39	42	38	33	25	45

Sound power spectrum (dB(A))

Working point		63	125	250	500	1000	2000	4000	8000	LwA
1	INLET	34	47	64	65	67	68	65	66	74
	OUTLET	34	46	66	65	68	70	65	60	75
	BREAK-OUT	20	36	43	48	54	56	49	42	59
2	INLET	41	43	60	67	70	66	61	60	73
	OUTLET	34	46	62	66	68	68	58	55	73
	BREAK-OUT	28	32	39	51	57	54	45	36	59
3	INLET	45	52	65	66	68	67	61	54	73
	OUTLET	44	54	64	65	68	70	59	52	73
	BREAK-OUT	32	41	44	49	55	55	45	31	59
4	INLET	32	46	63	64	66	66	63	64	72
	OUTLET	33	45	65	64	67	69	64	59	73
	BREAK-OUT	19	35	42	47	53	55	47	41	58
5	INLET	39	41	58	65	68	64	59	58	71
	OUTLET	32	44	60	64	66	66	56	53	71
	BREAK-OUT	25	30	37	49	54	52	43	34	57
6	INLET	43	49	62	64	66	65	59	52	71
	OUTLET	41	52	62	63	66	67	57	50	71
	BREAK-OUT	29	39	42	47	53	53	43	29	57
7	INLET	30	44	61	62	64	65	61	62	70
	OUTLET	31	43	63	62	65	67	62	57	71
	BREAK-OUT	17	33	40	45	51	53	46	39	56
8	INLET	36	38	55	62	65	61	56	55	68
	OUTLET	29	41	57	61	63	63	53	50	68
	BREAK-OUT	22	27	34	46	51	49	40	31	54
9	INLET	40	46	59	60	63	62	55	49	68
	OUTLET	38	48	59	59	63	64	54	47	68
	BREAK-OUT	26	35	38	44	50	50	39	25	54

PERFORMANCE CURVES - ACOUSTIC CHARACTERISTICS

- q_v : Airflow in m^3/h .
- p_{sf} : Static pressure in Pa.
- P: Input power in W.
- SFP: Specific fan power in $W/m^3/s$ (blue curves).
- Performance data in accordance with ISO 5801.

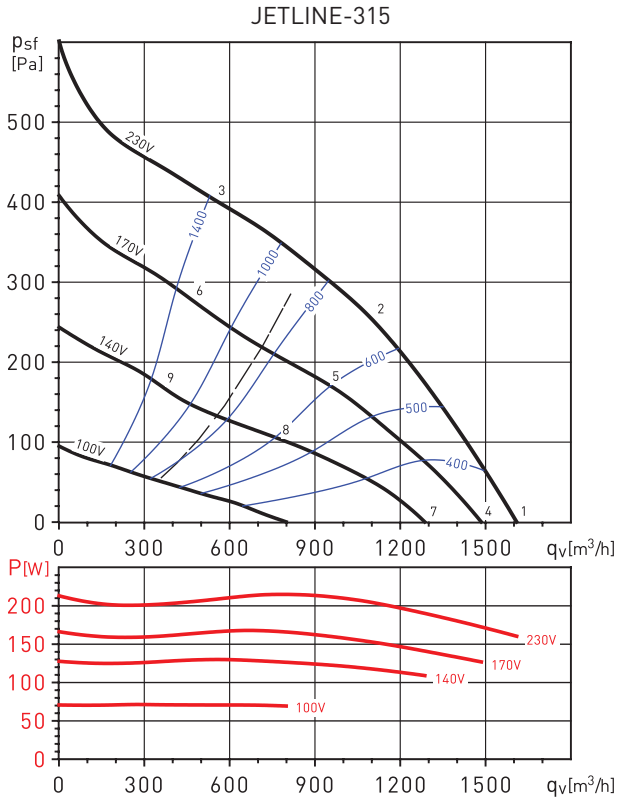

Sound power spectrum (dB(A))

Working point	63	125	250	500	1000	2000	4000	8000	LwA	
1	INLET	44	54	66	66	68	69	69	67	75
	OUTLET	39	51	67	70	74	73	70	63	79
	BREAK-OUT	29	48	60	55	61	58	53	44	66
2	INLET	33	49	62	67	68	66	61	62	73
	OUTLET	36	50	62	67	70	70	60	57	75
	BREAK-OUT	18	43	56	56	61	55	46	39	64
3	INLET	44	56	67	66	68	67	61	55	74
	OUTLET	46	57	66	68	73	73	61	53	77
	BREAK-OUT	29	51	62	55	61	56	45	32	65
4	INLET	42	52	65	64	66	67	67	65	74
	OUTLET	37	49	65	68	72	72	69	61	77
	BREAK-OUT	27	47	59	53	59	56	51	42	64
5	INLET	30	45	58	63	64	63	58	58	69
	OUTLET	32	46	58	63	67	66	56	53	71
	BREAK-OUT	14	40	52	52	57	52	42	35	60
6	INLET	40	52	64	62	64	63	57	52	70
	OUTLET	42	53	62	64	69	69	57	49	73
	BREAK-OUT	25	47	58	51	57	52	41	28	62
7	INLET	39	49	62	61	63	64	64	62	71
	OUTLET	34	46	62	65	69	69	66	58	74
	BREAK-OUT	24	44	56	50	56	53	48	39	61
8	INLET	24	40	53	58	59	57	52	53	64
	OUTLET	27	41	53	58	61	61	51	48	66
	BREAK-OUT	9	35	47	47	52	46	37	30	55
9	INLET	34	47	58	56	59	58	52	46	64
	OUTLET	36	47	56	59	64	63	51	44	68
	BREAK-OUT	19	42	52	46	52	47	36	23	56

MOUNTING ACCESSORIES



MBE
Electric heater.

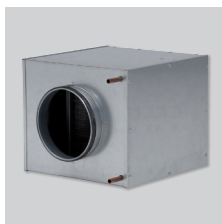

MBW
Hot water coil.



SIL
Circular sound attenuators.



MFL-G4
Filtration box of G4 grade filtration.

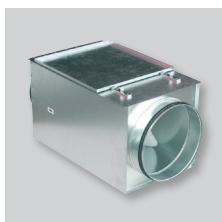

MFL-F
Box in galvanized steel for inserting the MFR F5, F6 and F7 filters.



CAR
Backdraught shutters.



GSA M0
Aluminium flexible ducting.



GSI M0
Insulated aluminium ducting.



CX
Worm drive duct connectors.



BOC
Metal inlet valves.



BOR
Plastic inlet valves.



GCI
Circular inlet grilles.



VR
GCI mounting frame.



GRI
Interior square grilles.

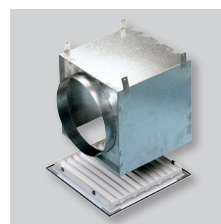

RP
GRI mounting frame.



ACOP-VENT
Flexible connectors.



DEF-VENT
Protection grille.

ELECTRICAL ACCESSORIES



REB
Electronic single phase speed controllers.



RMB
Autotransformer single phase speed controllers.