



Opis Industrijska rekuperacijska rešetka.
Razmik lamel: 60 mm.
Fiksni naklon lamel: 45°.
Namestitev na steno za dovod ali odvod zraka.

Material Anodiziran aluminij.

Pritrditev Pritrditev s sponami ali z vijaki (po naročilu).

Dodatki Regulacijski nastavek s protismernimi lamelami.
Montažni protiokvir iz pocinkane pločevine.
Mreža proti mrčesu in pticam.
Loputa za prekomerni tlak.

RAZ

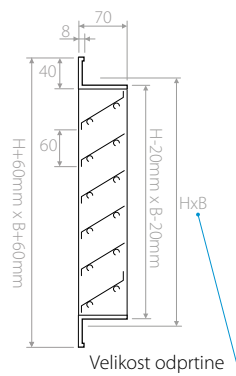

RAZ+SCAI

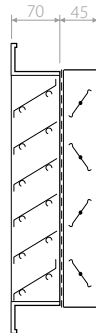

RAZ-R

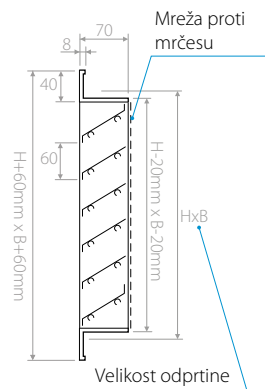

RAZ-RZ

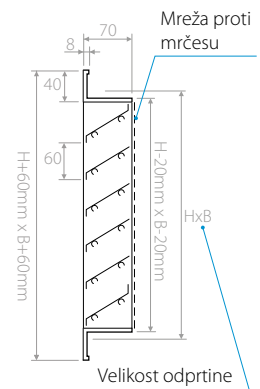

RAZ-RSSA

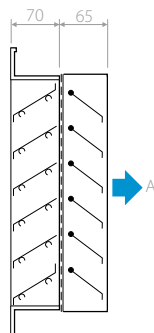

RAZ-RSSE

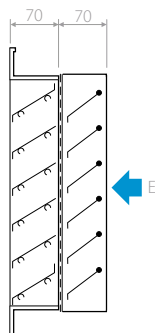

RAZ-TEG

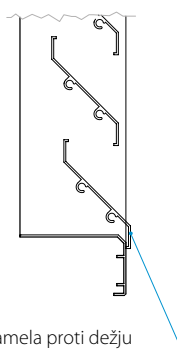

CTP-RAZ

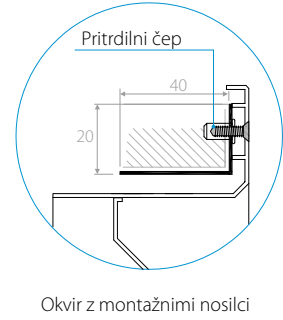

Načna pritrditve

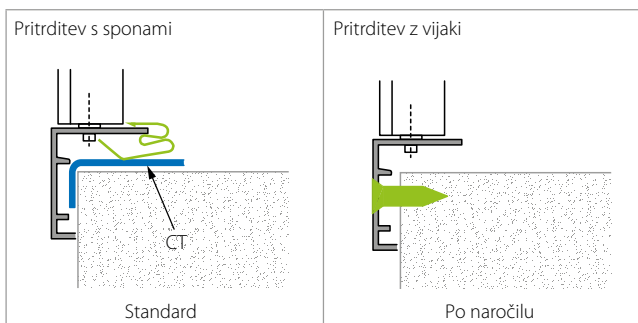

Luknje za vijake

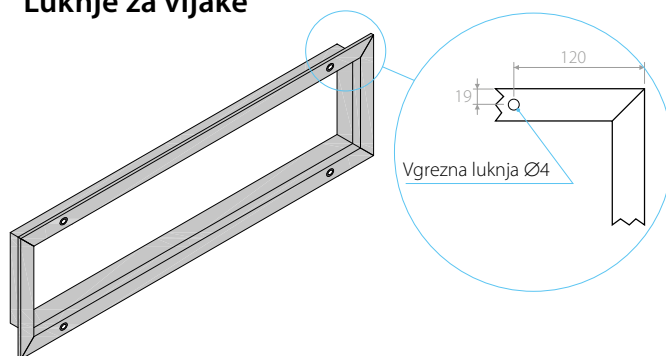
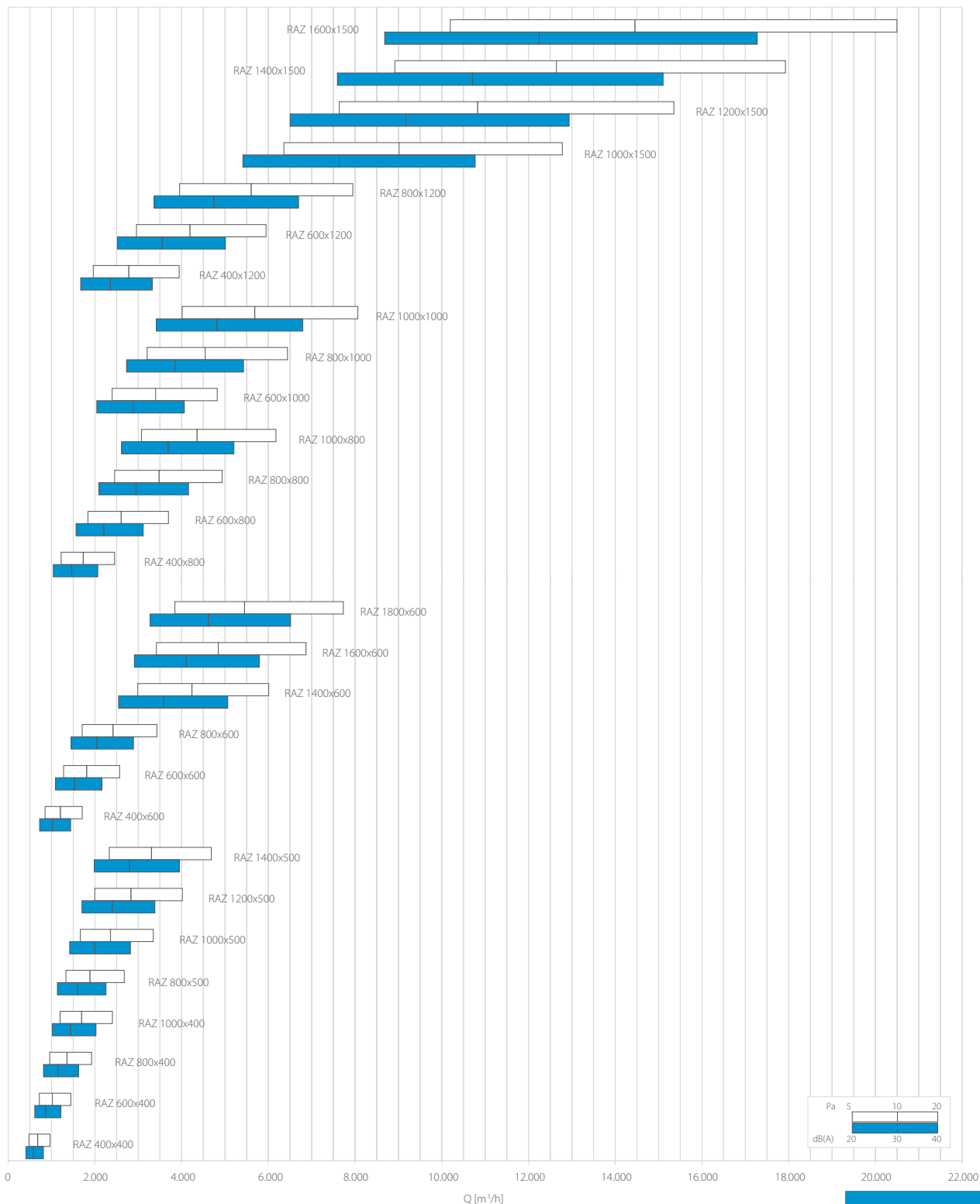

Diagram za hitro izbiro



Izbirna tabela

	A_k [m ²]	Q [m ³ /h]		L_{WA} [dB(A)]		Dp_t [Pa]	
		min	max	min	max	min	max
RAZ 400x400	0,0771	480	970	25	45	5	20
RAZ 600x400	0,1153	720	1450	25	45	5	20
RAZ 800x400	0,1535	960	1930	25	45	5	20
RAZ 1000x400	0,1917	1200	2410	25	45	5	20
RAZ 1200x400	0,2299	1440	2880	25	45	5	20
RAZ 1400x400	0,2681	1670	3360	25	45	5	20
RAZ 1600x400	0,3063	1910	3840	25	45	5	20
RAZ 1800x400	0,3445	2150	4320	25	45	5	20
RAZ 2000x400	0,3827	2390	4800	25	45	5	20
RAZ 400x500	0,1068	670	1340	25	45	5	20
RAZ 500x500	0,1335	830	1670	25	45	5	20
RAZ 600x500	0,1602	1000	2010	25	45	5	20
RAZ 800x500	0,2135	1330	2680	25	45	5	20
RAZ 1000x500	0,2669	1670	3350	25	45	5	20
RAZ 1200x500	0,3203	2000	4020	25	45	5	20
RAZ 1400x500	0,3736	2330	4690	25	45	5	20
RAZ 1600x500	0,4270	2670	5360	25	45	5	20
RAZ 1800x500	0,4804	3000	6030	25	45	5	20
RAZ 2000x500	0,5338	3330	6700	25	45	5	20
RAZ 400x600	0,1365	850	1710	25	45	5	20
RAZ 600x600	0,2050	1280	2570	25	45	5	20
RAZ 800x600	0,2735	1710	3430	25	45	5	20
RAZ 1000x600	0,3421	2140	4290	25	45	5	20
RAZ 1200x600	0,4106	2560	5150	25	45	5	20
RAZ 1400x600	0,4792	2990	6010	25	45	5	20
RAZ 1600x600	0,5477	3420	6870	25	45	5	20
RAZ 1800x600	0,6162	3850	7730	25	45	5	20
RAZ 2000x600	0,6848	4270	8590	25	45	5	20
RAZ 400x800	0,1958	1220	2460	25	45	5	20
RAZ 600x800	0,2947	1840	3700	25	45	5	20
RAZ 800x800	0,3936	2460	4940	25	45	5	20
RAZ 1000x800	0,4924	3070	6180	25	45	5	20
RAZ 1200x800	0,5913	3690	7420	25	45	5	20
RAZ 1400x800	0,6902	4310	8660	25	45	5	20
RAZ 1600x800	0,7890	4920	9900	25	45	5	20
RAZ 1800x800	0,8879	5540	11140	25	45	5	20
RAZ 2000x800	0,9868	6160	12380	25	45	5	20
RAZ 400x1000	0,2552	1590	3200	25	45	5	20
RAZ 600x1000	0,3844	2400	4820	25	45	5	20
RAZ 800x1000	0,5136	3210	6440	25	45	5	20
RAZ 1000x1000	0,6428	4010	8070	25	45	5	20
RAZ 1200x1000	0,7720	4820	9690	25	45	5	20
RAZ 1400x1000	0,9012	5620	11310	25	45	5	20
RAZ 1600x1000	1,0304	6430	12930	25	45	5	20
RAZ 1800x1000	1,1596	7240	14550	25	45	5	20
RAZ 2000x1000	1,2888	8040	16170	25	45	5	20
RAZ 400x1200	0,3146	1960	3950	25	45	5	20
RAZ 600x1200	0,4741	2960	5950	25	45	5	20
RAZ 800x1200	0,6336	3950	7950	25	45	5	20
RAZ 1000x1200	0,7932	4950	9950	25	45	5	20
RAZ 1200x1200	0,9527	5950	11950	25	45	5	20
RAZ 1400x1200	1,1122	6940	13950	25	45	5	20
RAZ 1600x1200	1,2718	7940	15960	25	45	5	20
RAZ 1800x1200	1,4313	8930	17960	25	45	5	20
RAZ 2000x1200	1,5908	9930	19960	25	45	5	20
RAZ 400x1500	0,4036	2520	5060	25	45	5	20
RAZ 600x1500	0,6086	3800	7640	25	45	5	20
RAZ 800x1500	0,8137	5080	10210	25	45	5	20
RAZ 1000x1500	1,0187	6360	12780	25	45	5	20
RAZ 1200x1500	1,2237	7640	15350	25	45	5	20
RAZ 1400x1500	1,4288	8920	17930	25	45	5	20
RAZ 1600x1500	1,6338	10200	20500	25	45	5	20
RAZ 1800x1500	1,8388	11480	23070	25	45	5	20
RAZ 2000x1500	2,0439	12760	25640	25	45	5	20
RAZ 2000x1600	2,1949	13700	27540	25	45	5	20
RAZ 2000x2000	2,7989	17470	35120	25	45	5	20