

CARATTERISTICHE:

Griglie pedonabili a barre fisse orizzontali passo 12,5 mm con cornice.

COSTRUZIONE:

Alluminio anodizzato.

IMPIEGO:

A pavimento, in mandata o ripresa.

FISSAGGIO:

Fissaggio con viti.

ACCESSORI:

- Serranda di taratura in acciaio zincato con alette a movimento contrapposto.

CHARACTERISTICS:

Floor grilles composed BY horizontal fixed bars with 12,5 mm pitch, with frame.

CONSTRUCTION:

Anodized aluminium.

UTILIZATION:

For floor installation and for air intake or delivery.



FIXING:

Fixing by using screws.

ACCESSORIES:

- Calibration damper made of galvanized steel and fins with opposite movement.

PREZZI - PRICES

		
BxH	GRPZ	SCZ
mm	€	€
300x100		
300x150		
400x100		
400x150		
400x200		
500x100		
500x150		
500x200		
500x300		
600x100		
600x150		
600x200		
600x300		
600x400		
800x100		
800x150		
800x200		
800x300		
800x400		
1000x100		
1000x150		
1000x200		
1000x300		
1000x400		

ACCESSORI - ACCESSORIES:

SCZ: Serranda di taratura ad alette con movimento contrapposto - Opposed blade damper

DISEGNI - DRAWINGS



DIAGRAMMA SCELTA RAPIDA - QUICK SELECTION DIAGRAM

GRI

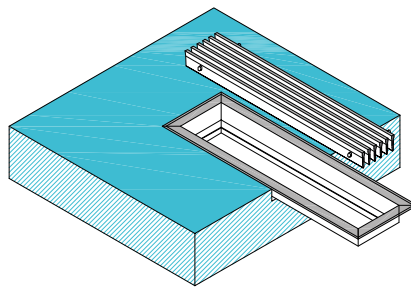
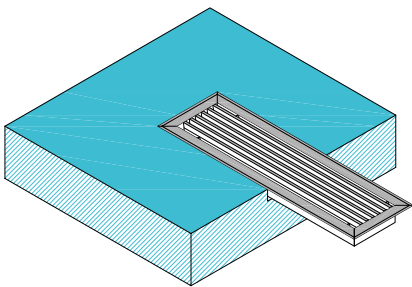
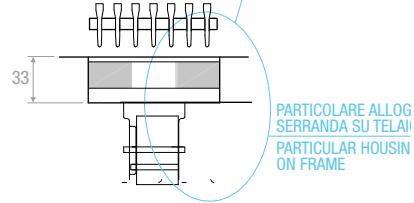
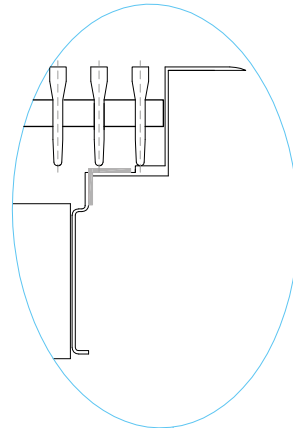
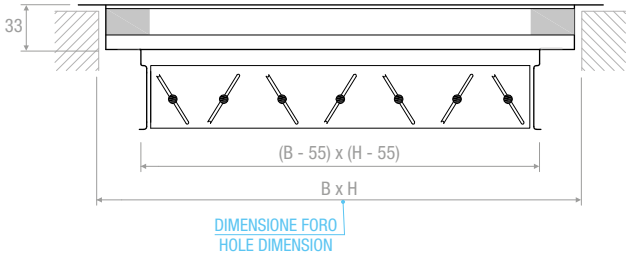
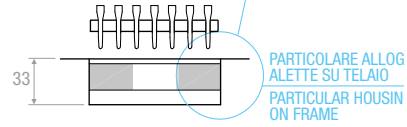
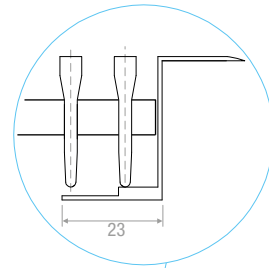
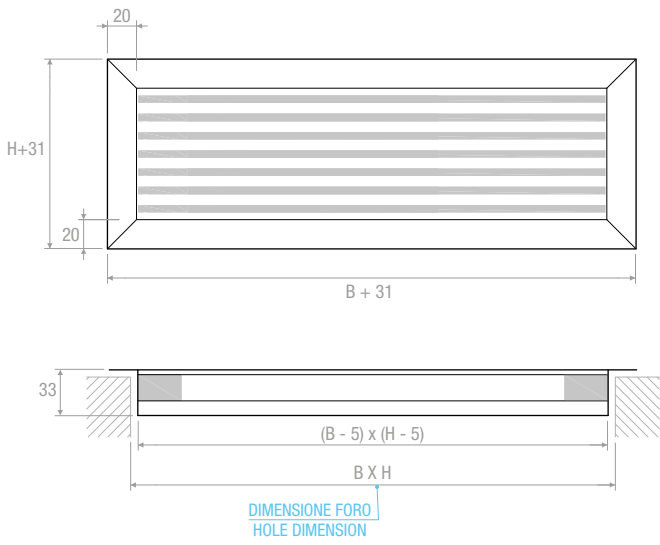

TABELLA DI SELEZIONE - SELECTION TABLE

Modello - Model	A _x [m ²]	Q [m ³ /h]		L _{WA} [dB(A)]		Y (0,25) [m]		Dp _i [Pa]	
		min	max	min	max	min	max	min	max
GRPZ 300x100	0,0126	120	240	21	38	2,2	4,9	5	20
GRPZ 400x100	0,0172	160	330	22	40	2,6	5,9	5	20
GRPZ 500x100	0,0220	210	420	24	41	3,2	6,7	5	20
GRPZ 600x100	0,0268	250	510	25	42	3,5	7,4	5	20
GRPZ 800x100	0,0368	350	700	27	44	4,2	8,8	5	20
GRPZ 1000x100	0,0470	450	900	28	45	4,9	10,0	5	20
GRPZ 300x150	0,0196	190	370	24	40	3,1	6,3	5	20
GRPZ 400x150	0,0268	250	510	25	42	3,5	7,6	5	20
GRPZ 500x150	0,0343	320	650	26	43	4,1	8,6	5	20
GRPZ 600x150	0,0418	400	800	28	44	4,7	9,6	5	20
GRPZ 800x150	0,0573	540	1100	29	46	5,4	11,3	5	20
GRPZ 1000x150	0,0732	690	1400	30	47	6,2	12,7	5	20
GRPZ 400x200	0,0368	350	700	27	44	4,4	9,1	5	20
GRPZ 500x200	0,0470	450	900	28	45	5,0	10,3	5	20
GRPZ 600x200	0,0573	540	1100	29	46	5,5	11,4	5	20
GRPZ 800x200	0,0785	740	1500	30	48	6,5	13,3	5	20
GRPZ 1000x200	0,1003	950	1920	32	49	7,4	15,1	5	20
GRPZ 500x300	0,0732	690	1400	30	47	6,4	13,1	5	20
GRPZ 600x300	0,0893	850	1710	31	48	7,1	14,5	5	20
GRPZ 800x300	0,1224	1160	2340	33	50	8,3	16,9	5	20
GRPZ 1000x300	0,1563	1480	2990	34	51	9,4	19,1	5	20
GRPZ 600x400	0,1224	1160	2340	33	50	8,4	17,1	5	20
GRPZ 800x400	0,1677	1590	3200	34	51	9,8	20,0	5	20
GRPZ 1000x400	0,2141	2030	4090	36	53	11,1	22,5	5	20

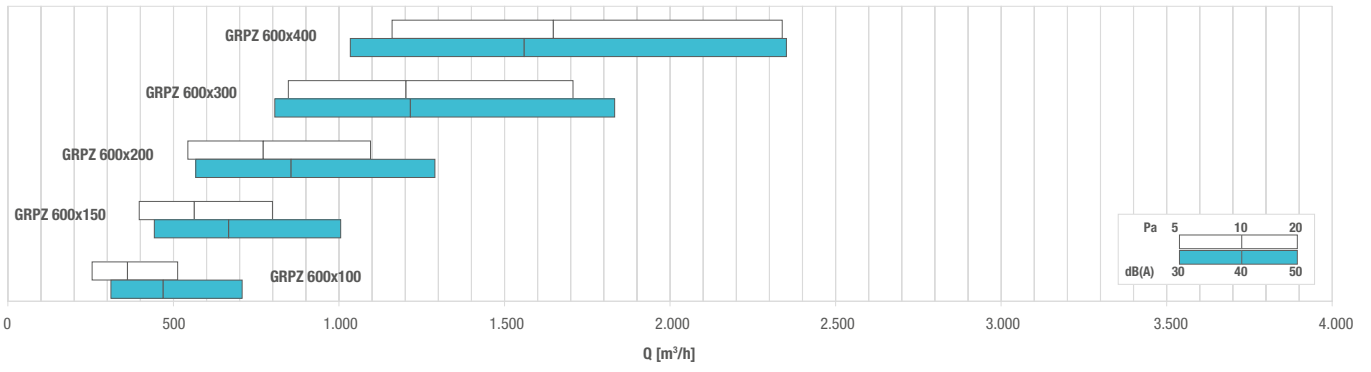