



### CARATTERISTICHE:

Griglie di ripresa industriali ad alette fisse inclinate di 45° passo 60 mm.

### COSTRUZIONE:

Alluminio anodizzato.

### IMPIEGO:

A parete, per presa aria esterna o espulsione.

### FISSAGGIO:

Fissaggio con clips o viti frontali a richiesta.

### ACCESSORI:

- Serranda di taratura in acciaio zincato con alette a movimento contrapposto.
- Controtelaio di montaggio in lamiera di acciaio zincato.
- Rete antivolatile.
- Serranda di sovrappressione a gravità.

### CHARACTERISTICS:

Industrial return grilles with fixed and 45° inclined bars 60 mm pitch.

### CONSTRUCTION:

Anodized aluminium.

### UTILIZATION:

For wall installation and for external air intake or exhaust air flow.

### FIXING:

Fixing by clips or frontal screws on request.

### ACCESSORIES:





- Calibration damper made of galvanized steel and fins with opposite movement.
- Mounting counterframes made of galvanized steel sheet.
- Bird screen.
- Overpressure damper.

## PREZZI - PRICES

BxH	GRAI	GRAIR	GRAIRZ	GRAIRSS	SCAI	CTP
mm	€	€	€	€	€	€
400x400						
500x400						
600x400						
800x400						
1000x400						
• 1200x400						
• 1400x400						
• 1600x400						
• 1800x400						
• 2000x400						
400x500						
500x500						
600x500						
800x500						
1000x500						
• 1200x500						
• 1400x500						
• 1600x500						
• 1800x500						
• 2000x500						
400x600						
600x600						
800x600						
1000x600						
• 1200x600						
• 1400x600						
• 1600x600						
• 1800x600						
• 2000x600						
400x800						
600x800						
800x800						
1000x800						
• 1200x800						
• 1400x800						
• 1600x800						
• 1800x800						
• 2000x800						
400x1000						
600x1000						
800x1000						
1000x1000						
• 1200x1000						
• 1400x1000						
• 1600x1000						

• Rinforzo intermedio - Intermediate reinforcing

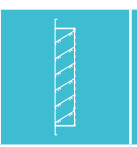
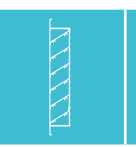
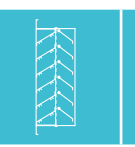
PREZZI - PRICES

						
BxH	GRAI	GRAIR	GRAIRZ	GRAIRSS	SCAI	CTP
mm	€	€	€	€	€	€
1800x1000						
2000x1000						
400x1200						
600x1200						
800x1200						
1000x1200						
1200x1200						
1400x1200						
1600x1200						
1800x1200						
2000x1200						
400x1500						
600x1500						
800x1500						
1000x1500						
1200x1500						
1400x1500						
1600x1500						
1800x1500						
2000x1500						
2000x1600						
2000x1800						
2000x2000						

**VERNICIATURA:**

Colori RAL 9010 - 9016: + 15%  
Altri colori: prezzi a richiesta

**DESCRIZIONI:**

**GRAI:** Griglia di ripresa passo 60 mm (standard). Passo 75 o 100 mm a richiesta  
**GRAIR:** Griglia di ripresa passo 60 mm in alluminio con rete antivolatile  
**GRAIRZ:** Griglia di ripresa passo 60 mm in alluminio con rete anti insetto (zanzariera)  
**GRAIRSS:** Griglia di ripresa passo 60 mm in alluminio con rete antivolatile e serranda di sovrappressione a gravità

**ESECUZIONI SU RICHIESTA:**

- griglia completa di tegolo anti pioggia  
+TEG +5% AUM

**ACCESSORI:**

**SC:** Serranda di taratura ad alette con movimento contrapposto  
**CTP:** Controtelaio di fissaggio in lamiera d'acciaio zincata.  
**PBZ:** Plenum di raccordo

**PAINTING:**

Color RAL 9010 - 9016: + 15%  
Different colors: prices on request

**DESCRIPTIONS:**

**GRAI:** Aluminium return grille 60 mm between bars (standard). 75 or 100 mm on request.  
**GRAIR:** Aluminium return grille 60 mm between bar with bird mesh  
**GRAIRZ:** Aluminium return grille 60 mm between bars with insect screen  
**GRAIRSS:** Aluminium return grille 60 mm between bars with bird mesh and overpressure damper

**AVAILABLE ON REQUEST:**

- griglie with rain-proof panel  
+TEG +5% INCREASE

**ACCESSORIES:**

**SC:** Opposed blade damper  
**CTP:** Counterframe in galvanised steel sheet profile section  
**PBZ:** Connecting plenum

**Nota: Passo 60 mm (standard)**

**Nota: Passo 75 o 100 mm a richiesta**  
60 mm between bars (standard)  
75 or 100 mm on request

• Rinforzo intermedio - Intermediate reinforcing

DISEGNI - DRAWINGS

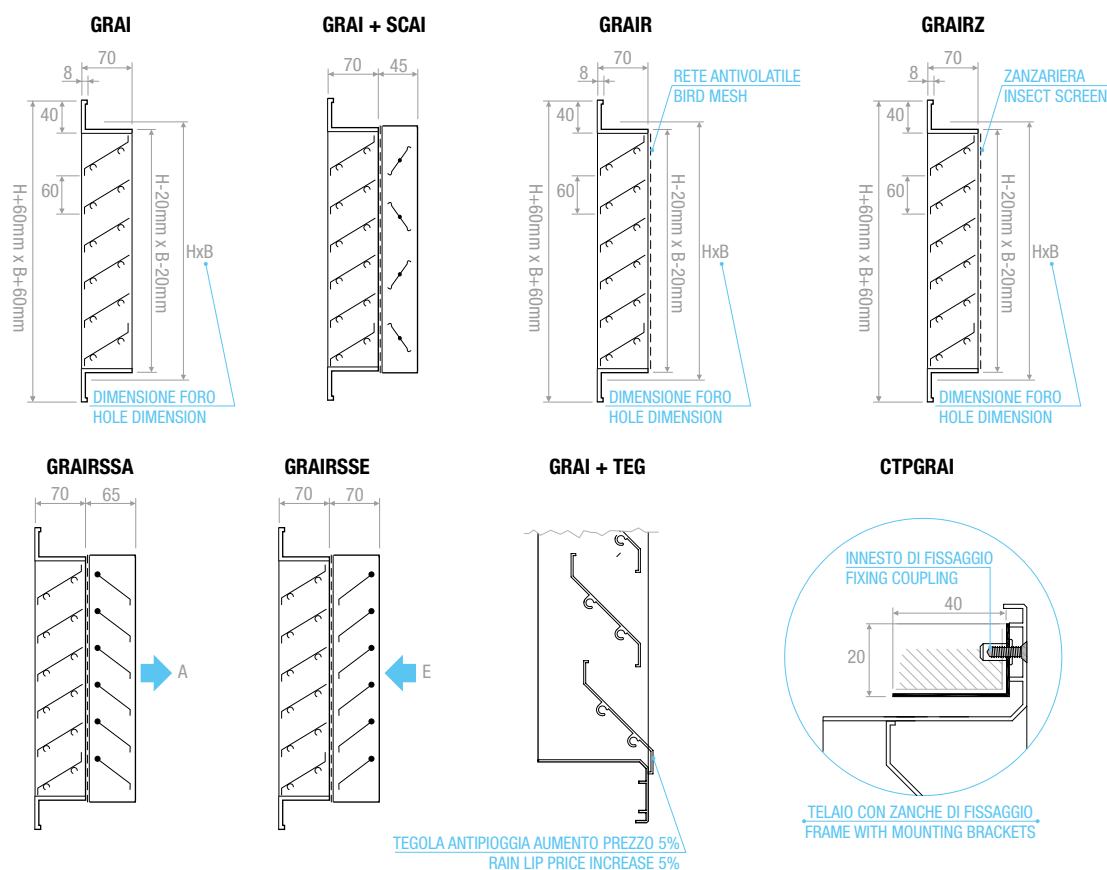

GRI

TIPO DI FISSAGGIO - TYPE OF FIXING



DIAGRAMMA SCELTA RAPIDA - QUICK SELECTION DIAGRAM



TABELLA DI SELEZIONE - SELECTION TABLE

Modello - Model	A <sub>k</sub> [m <sup>2</sup> ]	Q [m <sup>3</sup> /h]		L <sub>wa</sub> [dB(A)]		Dp <sub>t</sub> [Pa]	
		min	max	min	max	min	max
GRAI 400x400	0,0771	480	970	25	45	5	20
GRAI 600x400	0,1153	720	1450	25	45	5	20
GRAI 800x400	0,1535	960	1930	25	45	5	20
GRAI 1000x400	0,1917	1200	2410	25	45	5	20
GRAI 1200x400	0,2299	1440	2880	25	45	5	20
GRAI 1400x400	0,2681	1670	3360	25	45	5	20
GRAI 1600x400	0,3063	1910	3840	25	45	5	20
GRAI 1800x400	0,3445	2150	4320	25	45	5	20
GRAI 2000x400	0,3827	2390	4800	25	45	5	20
GRAI 400x500	0,1068	670	1340	25	45	5	20
GRAI 500x500	0,1335	830	1670	25	45	5	20
GRAI 600x500	0,1602	1000	2010	25	45	5	20
GRAI 800x500	0,2135	1330	2680	25	45	5	20
GRAI 1000x500	0,2669	1670	3350	25	45	5	20
GRAI 1200x500	0,3203	2000	4020	25	45	5	20
GRAI 1400x500	0,3736	2330	4690	25	45	5	20
GRAI 1600x500	0,4270	2670	5360	25	45	5	20
GRAI 1800x500	0,4804	3000	6030	25	45	5	20
GRAI 2000x500	0,5338	3330	6700	25	45	5	20
GRAI 400x600	0,1365	850	1710	25	45	5	20
GRAI 600x600	0,2050	1280	2570	25	45	5	20
GRAI 800x600	0,2735	1710	3430	25	45	5	20
GRAI 1000x600	0,3421	2140	4290	25	45	5	20
GRAI 1200x600	0,4106	2560	5150	25	45	5	20
GRAI 1400x600	0,4792	2990	6010	25	45	5	20
GRAI 1600x600	0,5477	3420	6870	25	45	5	20
GRAI 1800x600	0,6162	3850	7730	25	45	5	20
GRAI 2000x600	0,6848	4270	8590	25	45	5	20
GRAI 400x800	0,1958	1220	2460	25	45	5	20
GRAI 600x800	0,2947	1840	3700	25	45	5	20
GRAI 800x800	0,3936	2460	4940	25	45	5	20
GRAI 1000x800	0,4924	3070	6180	25	45	5	20
GRAI 1200x800	0,5913	3690	7420	25	45	5	20
GRAI 1400x800	0,6902	4310	8660	25	45	5	20
GRAI 1600x800	0,7890	4920	9900	25	45	5	20
GRAI 1800x800	0,8879	5540	11140	25	45	5	20
GRAI 2000x800	0,9868	6160	12380	25	45	5	20
GRAI 400x1000	0,2552	1590	3200	25	45	5	20
GRAI 600x1000	0,3844	2400	4820	25	45	5	20
GRAI 800x1000	0,5136	3210	6440	25	45	5	20
GRAI 1000x1000	0,6428	4010	8070	25	45	5	20
GRAI 1200x1000	0,7720	4820	9690	25	45	5	20
GRAI 1400x1000	0,9012	5620	11310	25	45	5	20
GRAI 1600x1000	1,0304	6430	12930	25	45	5	20
GRAI 1800x1000	1,1596	7240	14550	25	45	5	20
GRAI 2000x1000	1,2888	8040	16170	25	45	5	20
GRAI 400x1200	0,3146	1960	3950	25	45	5	20
GRAI 600x1200	0,4741	2960	5950	25	45	5	20
GRAI 800x1200	0,6336	3950	7950	25	45	5	20
GRAI 1000x1200	0,7932	4950	9950	25	45	5	20
GRAI 1200x1200	0,9527	5950	11950	25	45	5	20
GRAI 1400x1200	1,1122	6940	13950	25	45	5	20
GRAI 1600x1200	1,2718	7940	15960	25	45	5	20
GRAI 1800x1200	1,4313	8930	17960	25	45	5	20
GRAI 2000x1200	1,5908	9930	19960	25	45	5	20
GRAI 400x1500	0,4036	2520	5060	25	45	5	20
GRAI 600x1500	0,6086	3800	7640	25	45	5	20
GRAI 800x1500	0,8137	5080	10210	25	45	5	20
GRAI 1000x1500	1,0187	6360	12780	25	45	5	20
GRAI 1200x1500	1,2237	7640	15350	25	45	5	20
GRAI 1400x1500	1,4288	8920	17930	25	45	5	20
GRAI 1600x1500	1,6338	10200	20500	25	45	5	20
GRAI 1800x1500	1,8388	11480	23070	25	45	5	20
GRAI 2000x1500	2,0439	12760	25640	25	45	5	20
GRAI 2000x1600	2,1949	13700	27540	25	45	5	20
GRAI 2000x2000	2,7989	17470	35120	25	45	5	20

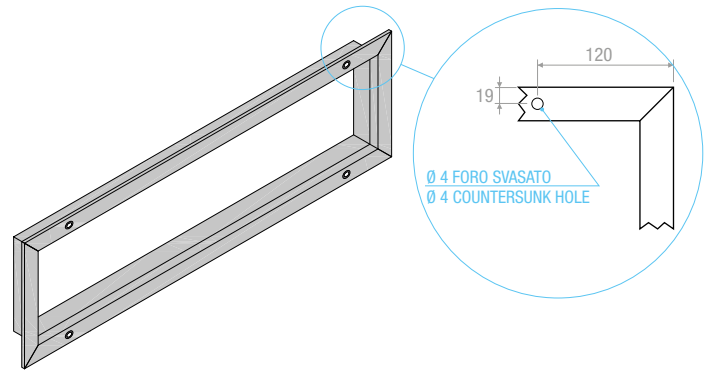
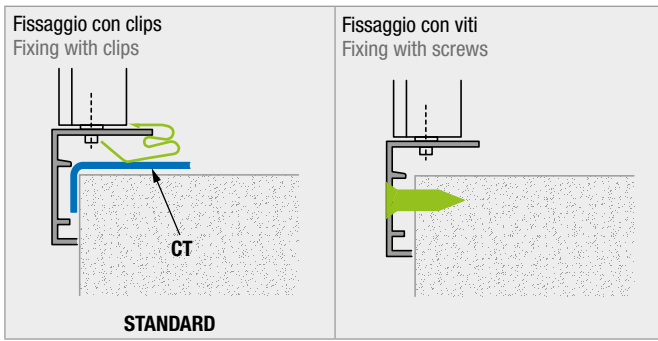
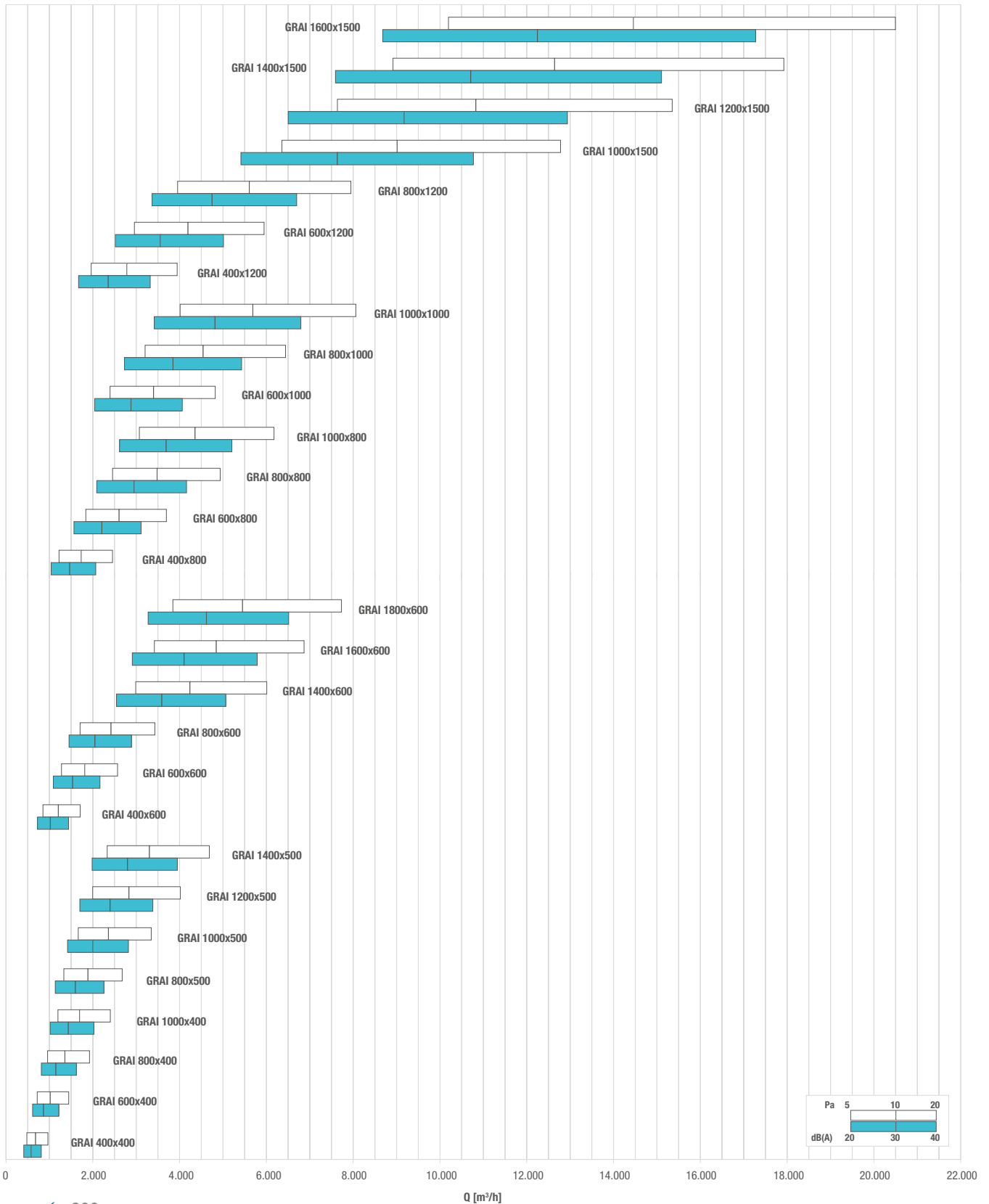