

DLFFP

**CARATTERISTICHE:**

Diffusori lineari a feritoie portafiltro.

COSTRUZIONE:

Alluminio anodizzato estruso.

IMPIEGO:

A soffitto, in mandata e ripresa.

Altezza di installazione:
2,5-3,1 m.

FISSAGGIO:

- Con staffa interna mobile.

ACCESSORI:

Plenum di raccordo in acciaio zincato con isolamento.

CHARACTERISTICS:

Filter linear slot diffusers.

CONSTRUCTION:

Anodized extruded aluminium.

UTILIZATION:

For ceiling installation and for air intake and delivery.

Installation height: 2,5-3,1 m.



FIXING:

- By inner mounting mobile bracket.

ACCESSORIES:

Galvanized steel connecting plenum with insulation.

PREZZI - PRICES

				
FERITOIE - SLOTS	LUNGHEZZA - LENGHT	DLF-FP	PDL	PDLI
N.	mm*	€	€	€
3	600			
	800			
	1000			
	1500			
	2000			
4	600			
	800			
	1000			
	1500			
	2000			
5	600			
	800			
	1000			
	1500			
	2000			

*N.B.: Prezzi con filtro incluso - Prices with filter included

*N.B.:Le lunghezze riportate sono da intendere passaggio aria - The lengths are actual neck sizes

VERNICIATURA - PAINTING:

Colori RAL 9010 - 9016: + 15% - Color RAL 9010 - 9016: + 15%

Altri colori: prezzi a richiesta - Different colors: prices on request

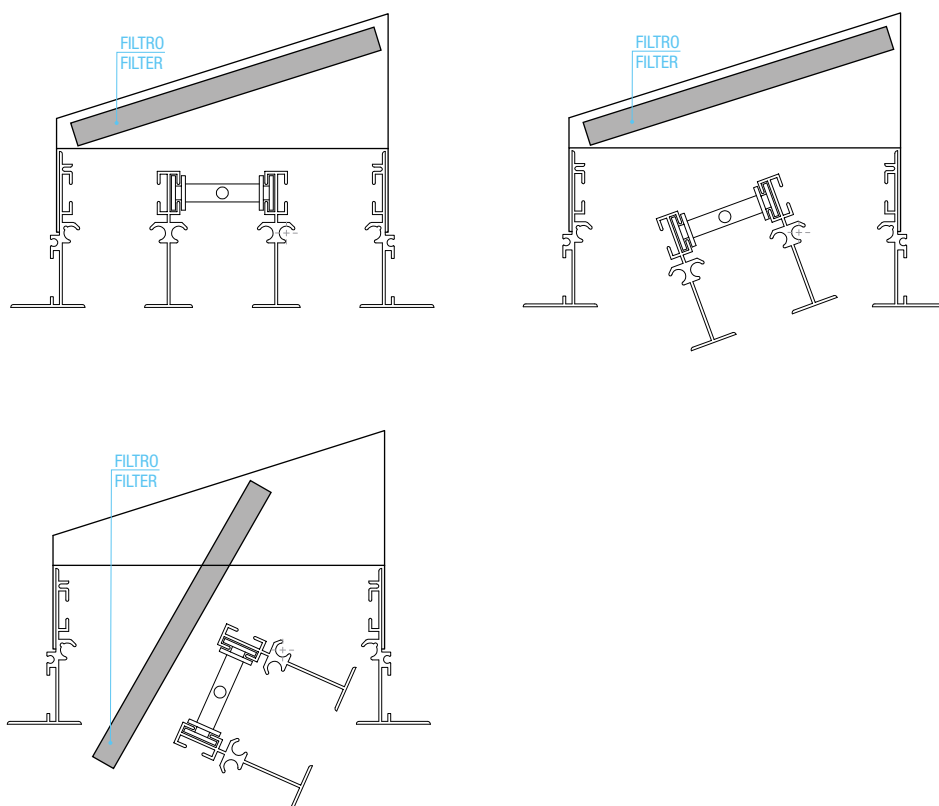
DISEGNI - DRAWINGS

MISURE - MEASURES

N. feritoie N. slots	Lunghezza mm Length mm	Ø collarino est. N. collarini Ø spigot N. spitos	A mm	B mm	C mm	S mm	Z mm	NR. CVL Cavalletti Mounting brackets
3	800	198-1	117	128	155	132	144	2
	1000	198-2						2
	1500	198-3						2
	2000	198-4						4
4	800	198-2	155	165	191	169	181	2
	1000	198-2						2
	1500	198-3						2
	2000	198-4						4
5	800	248-1	192	202	229	206	218	4
	1000	248-1						4
	1500	248-2						4
	2000	248-2						4

DISEGNI - DRAWINGS



DIAGRAMMA SCELTA RAPIDA - QUICK SELECTION DIAGRAM



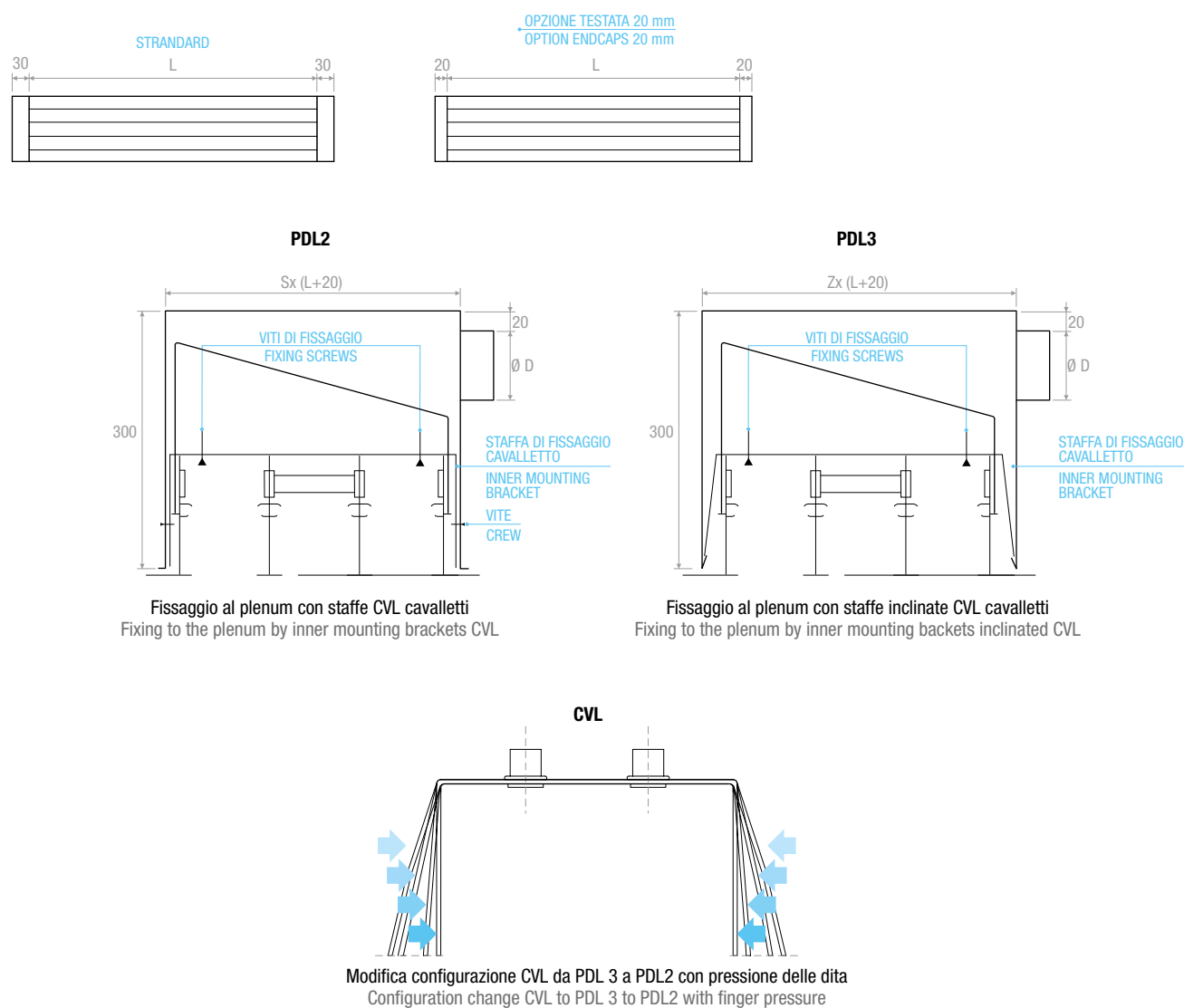

TABELLA DI SELEZIONE - SELECTION TABLE

Modello - Model	A _x [m²]	Q [m³/h]		L _{WA} [dB(A)]		Dp _t [Pa]	
		min	max	min	max	min	max
DLFFP3 1000	0,02149	140	380	17	41	10	50
DLFFP4 1000	0,02868	180	510	17	42	10	50
DLFFP5 1000	0,03588	230	640	18	42	10	50

ACCESSORI - ACCESSORIES

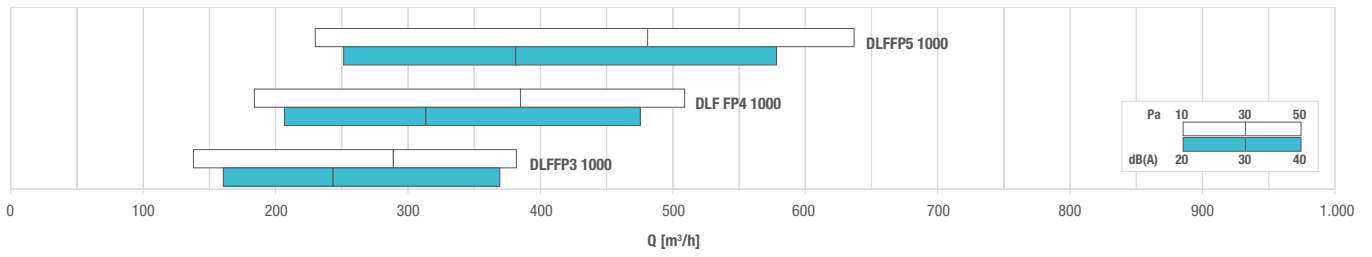
		€
CVL 1-4 Feritoie - 1-4 Slots		
CVL 5-8 Feritoie - 5-8 Slots		
CG Gancio - Hook		
CC Kit Continuità (2 pezzi) Kit continuity (2 pieces)		