

Opis Linearni režni difuzorji s filtrom.
Namestitev v strop za dovod ali odvod zraka.
Višina namestitve: 2,5 – 3,1 m.

Material Anodiziran ekstrudiran aluminij

Pritrditev S frontalnimi vijaki ali s premično notranjo spono.

Dodatki Povezovalna komora iz pocinkane pločevine z izolacijo.

Načrti

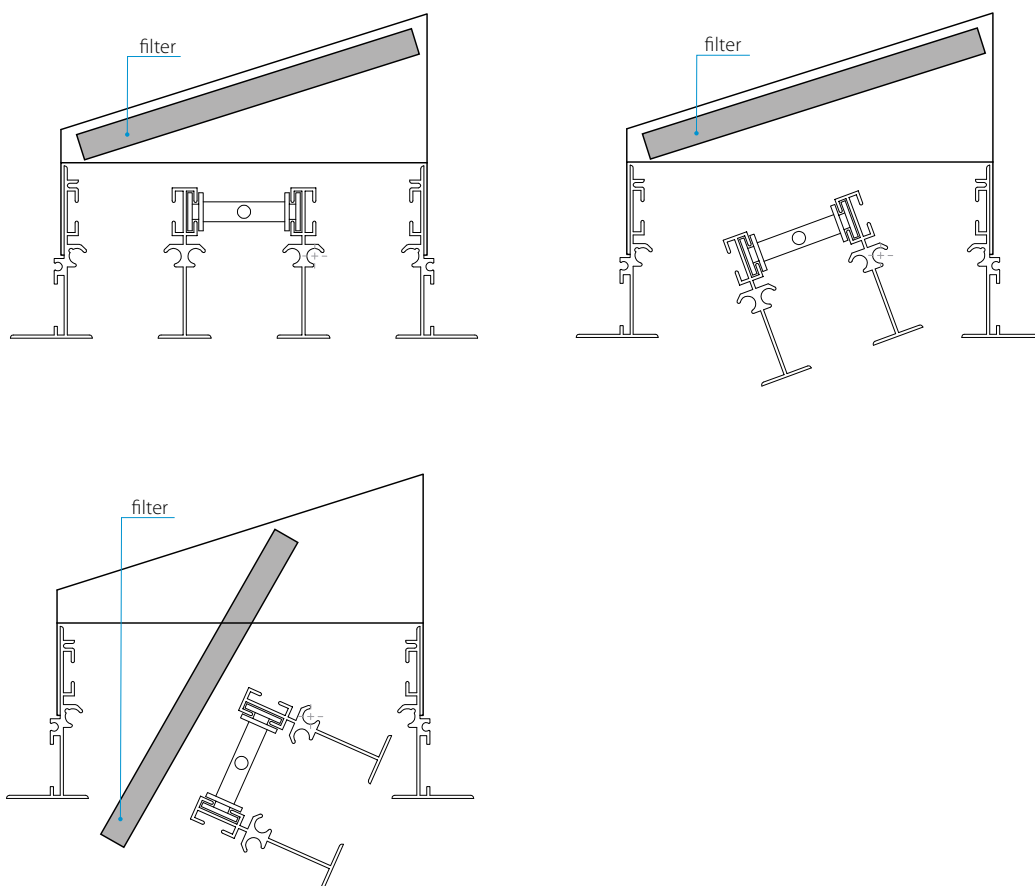

Dimenzije

Število rež	Dolžina [mm]	Ø priključkov - št. priključkov	A mm	B mm	C mm	S mm	Z mm	Število pritrdilnih nosilcev
3	800	198-1	117	128	155	132	144	2
	1000	198-2						2
	1500	198-3						2
	2000	198-4						4
4	800	198-2	155	165	191	169	181	2
	1000	198-2						2
	1500	198-3						2
	2000	198-4						4
5	800	248-1	192	202	229	206	218	4
	1000	248-1						4
	1500	248-2						4
	2000	248-2						4

Načrti

Standardna izvedba

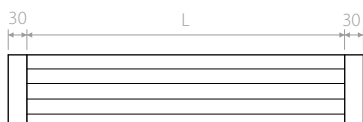

Opcijsko: Izvedba z zaključnimi čepi 20 mm

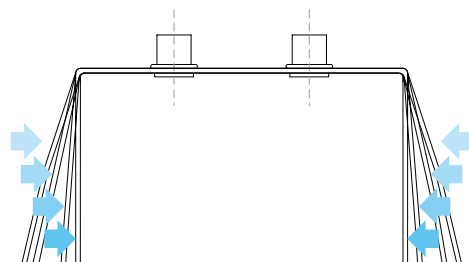
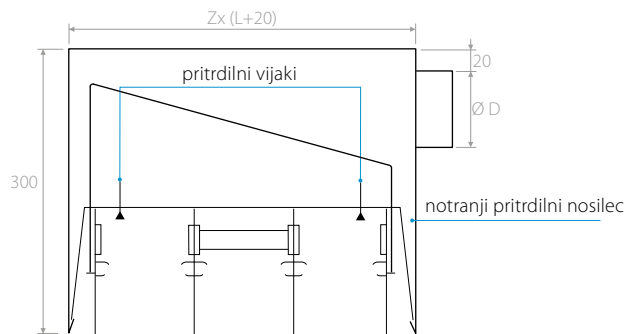
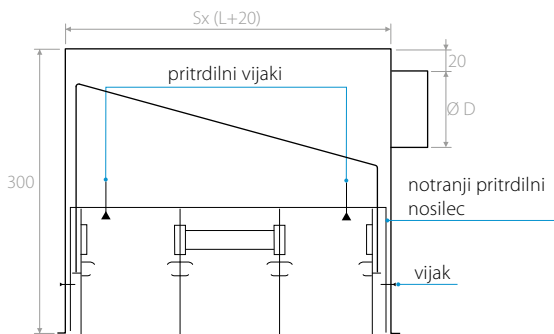
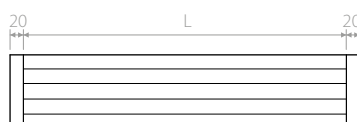

S pritiskom prsta spremenite konfiguracijo CVL v PDL 3 v PDL 2

Diagram za hitro izbiro

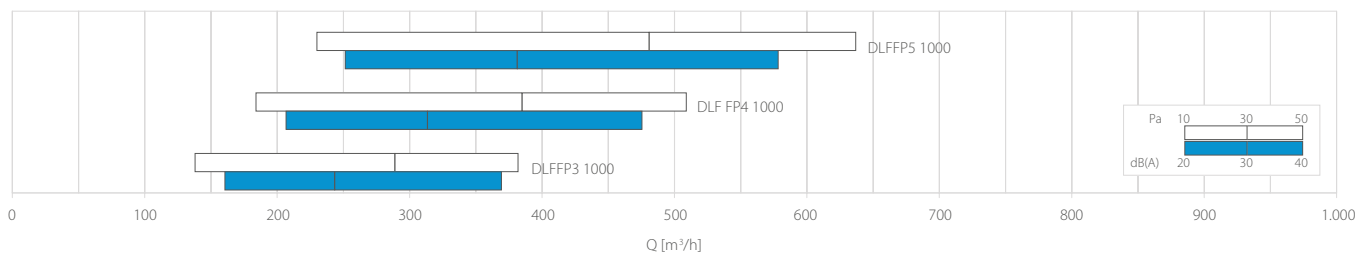

Izbirna tabela

Oznake	A_k [m^2]	Q [m^3/h]		L_{WA} [dB(A)]		Dp_l [Pa]	
		min	max	min	max	min	max
DLFFP3 1000	0,02149	140	380	17	41	10	50
DLFFP4 1000	0,02868	180	510	17	42	10	50
DLFFP5 1000	0,03588	230	640	18	42	10	50

Dodatki

CVLT za 1-4 rež	
CVLT za 5-8 rež	
CG kljuka	
CM povezovalni elementi (dva kosa)	