

- Characteristics** Multidirection 4-way diffusers with removable central part.
- Material** Aluminium.
- Finish** Anodised / RAL 9010.
- Fixing** Fixing by concealed fixing screws inserted in the diffuser neck.
- Accessories** R: Opposed blade damper
K: Connecting plenum

AQNA

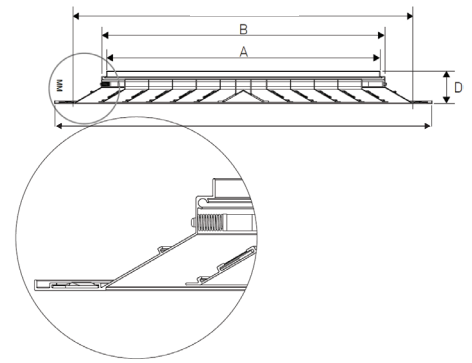

AQNA-R

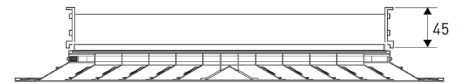

KK-V

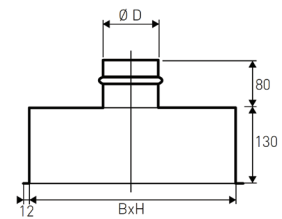

KK-H

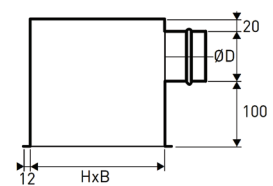

Sicherheitsinstallation

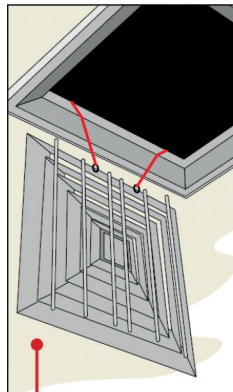

Sicherheitssystem



Spigot plenum K1 / K2

B × H [mm]	Ø D
150 × 150	122
225 × 225	147
300 × 300	197
375 × 375	197
450 × 450	247
600 × 600	297

AQNA Dimensions [mm]	A [mm]	B [mm]	C [mm]	D [mm]	E [mm]
150 x 100	128	144	294	50	240 x 240
225 x 225	203	219	369	50	315 x 315
300 x 300	278	294	444	50	390 x 390
375 x 375	353	369	519	50	465 x 465
450 x 450	428	444	594	50	540 x 540
600 x 600	580	597	745	50	690 x 690

Diagram of selection

CONDITIONS: valid with ceiling effect; terminal velocity = 0,5 m/s
 occupied zone relative velocity = 0,17 m/s; height of installation site = 2,8 m +/- 0,3 m

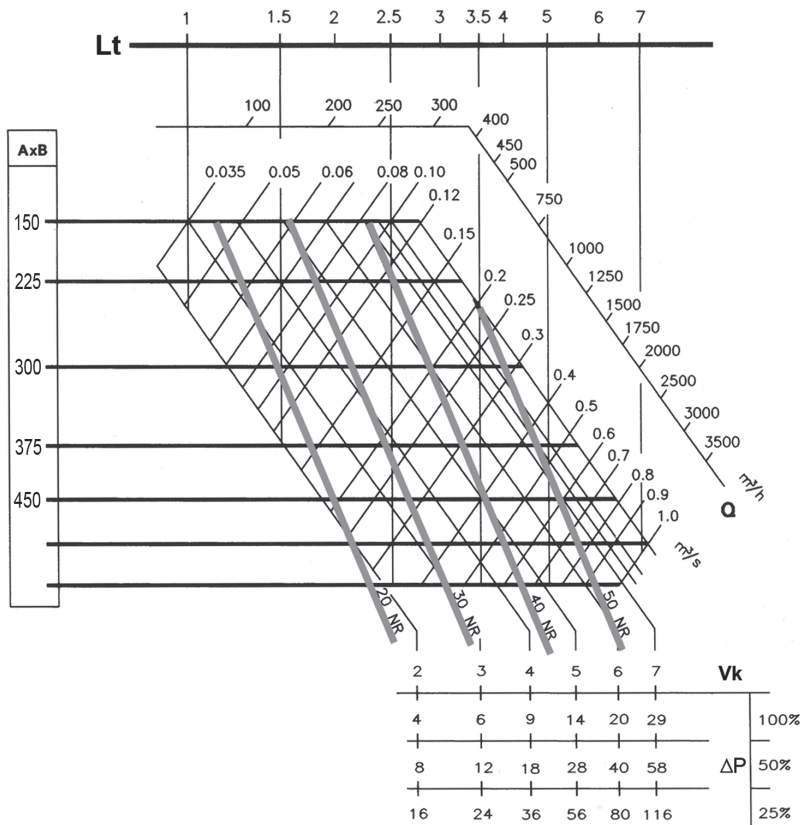

Selection key

AQNA - R / 300 x 300

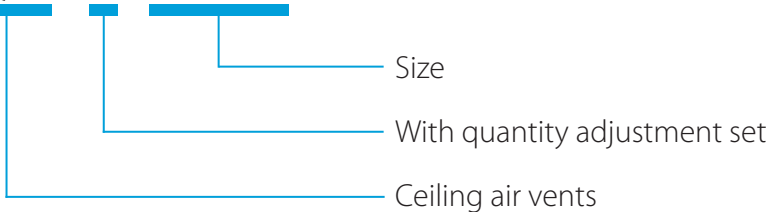

SYMBOL	DESCRIPTION
Q	Air flow [m³/s, m³/h]
NR	Noise level
DP	Pressure drop [Pa]
Vk	Air delivery velocity [m/s]
Lt	Throw [m]