



Opis Loputa za regulacijo zračnega pretoka.

Konstrukcija Razmik osi loput 150 mm. Pari loput z zrcalnimi nakloni.
Pare loput opira in zapira servo-motor prek zobniškega prenosa.

Material Ohišje: pocinkana jeklena pločevina.
Zobniki: plastika (najlon), po naročilu jeklo (za visoke temperature).

Pritrditev Z vijaki na vogalih ohišja..

Izvedbe ZR-150/R: zrcalne lopute z ročno nastavitvijo.
ZR-150/M: zrcalne lopute z ležiščem za servomotor (motor).
ZR-150-P/R: vzporedne lopute z ročno nastavitvijo.
ZR-150-P/M: vzporedne lopute z ležiščem za servomotor.
T10: furnirane lopute.

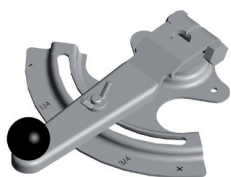

CM 10 - mehanizem za ročno nastavitev loput.

Izvedbe

Standardne lamele

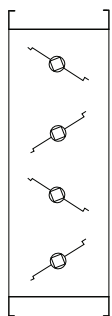

Ojačane lamele

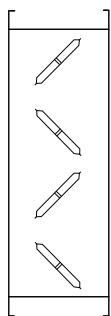

Zrcalne lamele

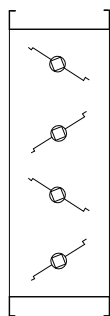

Vzporedne lamele

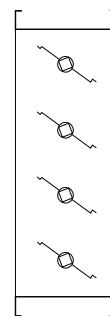

Univerzalna izvedba

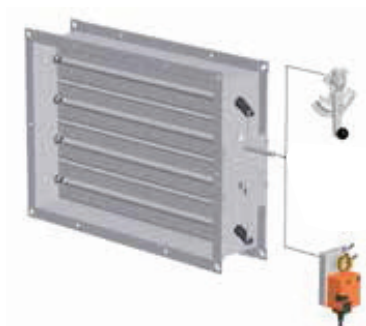

Ročna nastavitev lamel



Nastavitev s servomotorjem



Izvedbe konstrukcij

Standardne lamele

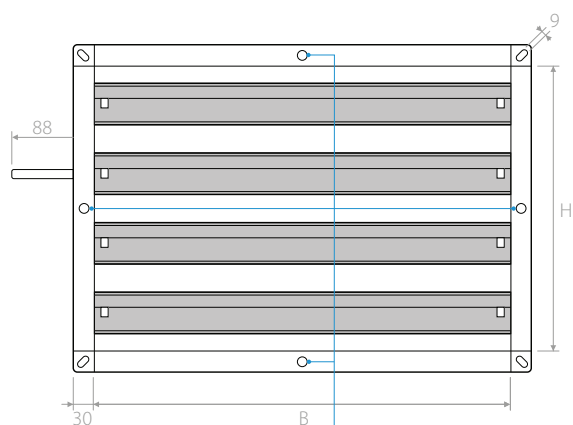

luknje \varnothing 9 mm, razmik 300 mm

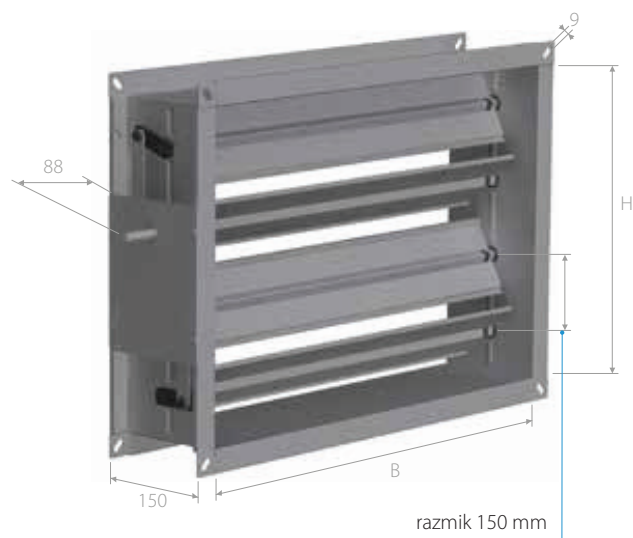

razmik 150 mm

Tabela velikosti servomotorjev

	200	300	400	500	600	700	800	900	1000	1100	1200	1300	1400	1500
310	0,06	0,09	0,12	0,16	0,19	0,22	0,25	0,28	0,31	0,34	0,37	0,4	0,43	0,47
460	0,09	0,14	0,18	0,23	0,28	0,32	0,37	0,41	0,46	0,51	0,55	0,6	0,64	0,69
610	0,12	0,18	0,24	0,31	0,37	0,43	0,49	0,55	0,61	0,67	0,73	0,79	0,85	0,92
760	0,15	0,23	0,3	0,38	0,46	0,53	0,61	0,68	0,76	0,84	0,91	0,99	1,06	1,14
910	0,18	0,27	0,36	0,46	0,55	0,64	0,73	0,82	0,91	1	1,09	1,18	1,27	1,37
1060	0,21	0,32	0,42	0,53	0,64	0,74	0,85	0,95	1,06	1,17	1,27	1,38	1,48	1,59
1210	0,24	0,36	0,48	0,61	0,73	0,85	0,97	1,09	1,21	1,33	1,45	1,57	1,69	1,82
1360	0,27	0,41	0,54	0,68	0,82	0,95	1,09	1,22	1,36	1,5	1,63	1,77	1,9	2,04
1510	0,3	0,45	0,6	0,76	0,91	1,06	1,21	1,36	1,51	1,66	1,81	1,96	2,11	2,27
1660	0,33	0,5	0,66	0,83	1	1,16	1,33	1,49	1,66	1,83	1,99	2,16	2,32	2,49
1810	0,36	0,54	0,72	0,91	1,09	1,27	1,45	1,63	1,81	1,99	2,17	2,35	2,53	2,72
1960	0,39	0,59	0,78	0,98	1,18	1,37	1,57	1,76	1,96	2,16	2,35	2,55	2,74	2,94
2110	0,42	0,63	0,84	1,06	1,27	1,48	1,69	1,9	2,11	2,32	2,53	2,74	2,95	3,17
2260	0,45	0,68	0,9	1,13	1,36	1,58	1,81	2,03	2,26	2,49	2,71	2,94	3,16	3,39
2410	0,48	0,72	0,96	1,21	1,45	1,69	1,93	2,17	2,41	2,65	2,89	3,13	3,37	3,62
2560	0,51	0,77	1,02	1,28	1,54	1,79	2,05	2,3	2,56	2,82	3,07	3,33	3,58	3,84
2710	0,54	0,81	1,08	1,36	1,63	1,9	2,17	2,44	2,71	2,98	3,25	3,52	3,79	4,07
2860	0,57	0,86	1,14	1,43	1,72	2	2,29	2,57	2,86	3,15	3,43	3,72	4	4,29
3010	0,6	0,9	1,2	1,51	1,81	2,11	2,41	2,71	3,01	3,31	3,61	3,91	4,21	4,52

	1600	1700	1800	1900	2000	2100	2200	2300	2400	2500	2600	2700	2800	2900	3000
310	0,5	0,53	0,56	0,59	0,62	0,65	0,68	0,71	0,74	0,78	0,81	0,84	0,87	0,9	0,93
460	0,74	0,78	0,83	0,87	0,92	0,97	1,01	1,06	1,1	1,15	1,2	1,24	1,29	1,33	1,38
610	0,98	1,04	1,1	1,16	1,22	1,28	1,34	1,4	1,46	1,53	1,59	1,65	1,71	1,77	1,83
760	1,22	1,29	1,37	1,44	1,52	1,6	1,67	1,75	1,82	1,9	1,98	2,05	2,13	2,2	2,28
910	1,46	1,55	1,64	1,73	1,82	1,91	2	2,09	2,18	2,28	2,37	2,46	2,55	2,64	2,73
1060	1,7	1,8	1,91	2,01	2,12	2,23	2,33	2,44	2,54	2,65	2,76	2,86	2,97	3,07	3,18
1210	1,94	2,06	2,18	2,3	2,42	2,54	2,66	2,78	2,9	3,03	3,15	3,27	3,39	3,51	3,63
1360	2,18	2,31	2,45	2,58	2,72	2,86	2,99	3,13	3,26	3,4	3,54	3,67	3,81	3,94	4,08
1510	2,42	2,57	2,72	2,87	3,02										
1660	2,66	2,82	2,99	3,15	3,32										
1810	2,9	3,08	3,26	3,44	3,62										
1960	3,14	3,33	3,53	3,72	3,92										

Izračunana površina v m²

Površina lopute < 0,4 m²

Površina lopute < 1 m²

Površina lopute < 2 m²

Površina lopute > 2 < 4 m²

Površina lopute > 4 < 8 m²

Tabela servomotorjev

Servomotorji brez povratne vzmeti

KODA	NAPETOST	UKAZ	€
CM24L	24 V	On-Off / 3-p	
CM230L	230 V	On-Off / 3-p	
CM24SRL	24 V	zvezni	



CM
za žaluzije do 0,4 m²
2 Nm

KODA	NAPETOST	UKAZ	€
LM24A	24 V	On-Off / 3-t.	
LM24AS	24 V	On-Off / 3-t.	
LM24ASR	24 V	zvezni	
LM230A	230 V	On-Off	
LM230AS	230 V	On-Off	
LM230ASR	230 V	zvezni	



LM
za žaluzije do 1 m²
5 Nm

KODA	NAPETOST	UKAZ	€
NM24A	24 V	On-Off / 3-t.	
NM24ASR	24 V	zvezni	
NM230A	230 V	On-Off	



NM
za žaluzije do 2 m²
10 Nm

KODA	NAPETOST	UKAZ	€
SM24A	24 V	On-Off / 3-t.	
SM24ASR	24 V	zvezni	
SM230A	230 V	On-Off / 3-t.	
SM230ASR	230 V	zvezni	



SM
za žaluzije do 4 m²
20 Nm

KODA	NAPETOST	UKAZ	€
GM24A	24 V	On-Off / 3-t.	
GM24ASR	24 V	zvezni	
GM230A	230 V	On-Off / 3-t.	



GM
za žaluzije do 8 m²
40 Nm

KODA	Št. kontaktov	PRIKLOPNA MOČ	PRIKLOP	€
S1A	1 x SPDT	1 mA ... 3 (0,5) A 250 V c.a.	LM - NM - SM - GM / 24-230 V	
S2A	2 x SPDT			



S1A



S2A

KODA	NAPETOST	HKRATNI PRIKLOP	PRIKLOP	€
SGA24	AC/DC 24 V	maks. 10 motorjev	LM - NM - SM - GM / 24-230 V	
SGF24				



SGA24



SGF24

Servomotorji s povratno vzmetjo

KODA	NAPETOST	UKAZ	€
TF24	24 V	On-Off	
TF24S	24 V	On-Off	
TF230	230 V	On-Off	
TF230S	230 V	On-Off	
TF24SR	24 V	zvezni	



TF
za žaluzije do 0,4 m²
2 Nm

KODA	NAPETOST	UKAZ	€
LF24	24 V	On-Off	
LF24S	24 V	On-Off	
LF230	230 V	On-Off	
LF230S	230 V	On-Off	
LF24SR	24 V	zvezni	



TF
za žaluzije do 0,8 m²
4 Nm

KODA	NAPETOST	UKAZ	€
NFA	230 VAC	On-Off	
NFAS2	230 VAC	On-Off	
NFA	24 VAC/DC	On-Off	
NFAS2	24 VAC/DC	On-Off	
NF24ASR	24 VAC/DC	zvezni	
NF24ASRS2	24 VAC/DC	zvezni	



NF
za žaluzije do 2 m²
10 Nm

KODA	NAPETOST	UKAZ	€
SFA	230 VAC	On-Off	
SFAS2	230 VAC	On-Off	
SFA	24 VAC/DC	On-Off	
SFAS2	24 VAC/DC	On-Off	
SF24ASR	24 VAC/DC	zvezni	
SF24ASRS2	24 VAC/DC	zvezni	



SF
za žaluzije do 4 m²
20 Nm

KODA	NAPETOST	UKAZ	€
EF230A	230 VAC	On-Off	
EF230AS2	230 VAC	On-Off	
EF24A	24 VAC/DC	On-Off	
EF24AS2	24 VAC/DC	On-Off	
EF24ASR	24 VAC/DC	zvezni	
EF24ASRS2	24 VAC/DC	zvezni	



EF
za žaluzije do 6 m²
30 Nm

Diagram za hitro izbiro

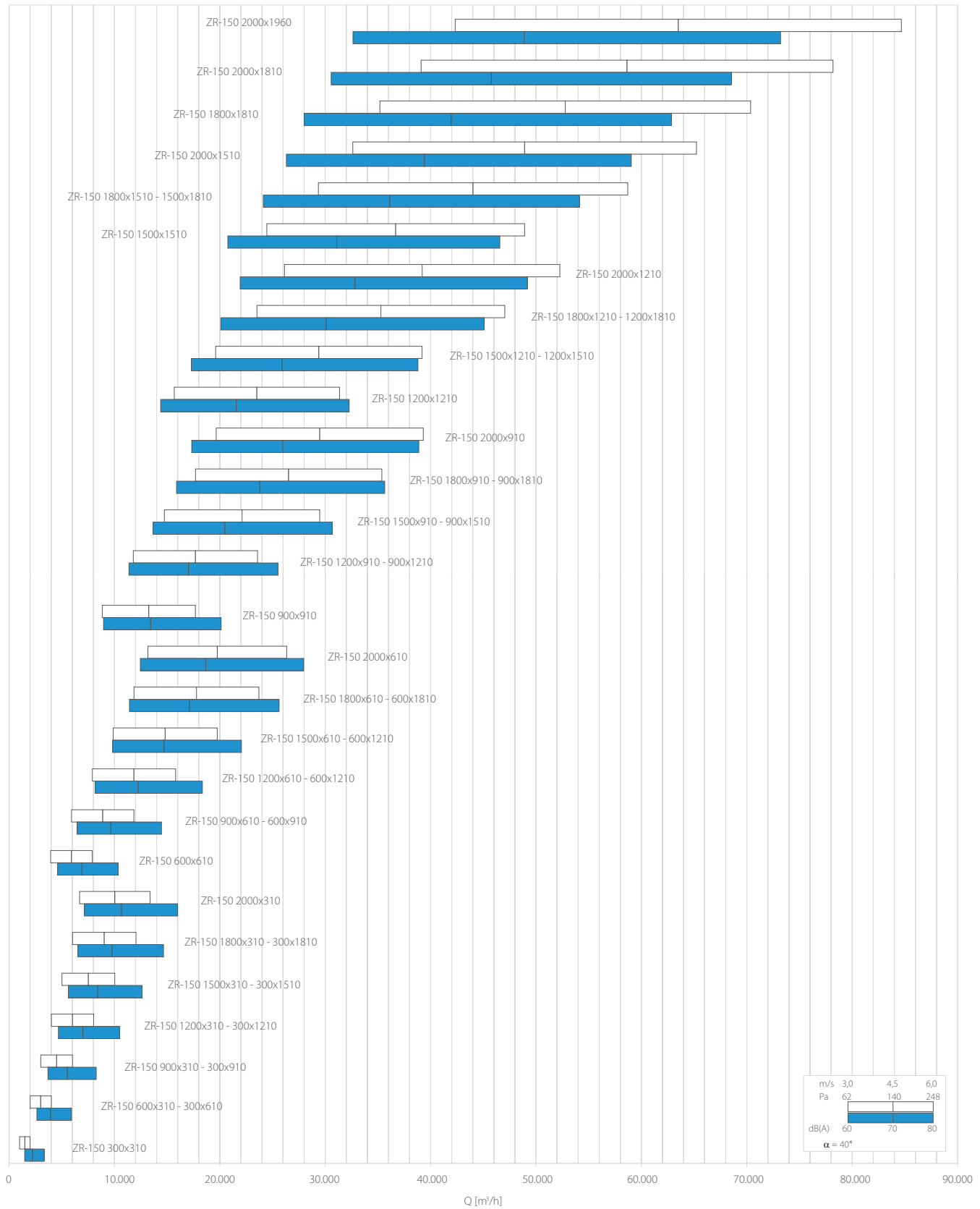

Izbirna tabela

Model	A ₁ [m ²]	v [m/s]		Q [m ³ /h]		Dp (α=40°) [Pa]		L _{WA} (α=40°) [dB(A)]	
		min	max	min	max	min	max	min	max
ZR-150 300x310	0,0930	3	6	1000	2010	62	248	50	67
ZR-150 600x310 - 300x610	0,1860	3	6	2010	4020	62	248	53	70
ZR-150 900x310 - 300x910	0,2790	3	6	3010	6030	62	248	55	72
ZR-150 1200x310 - 300x1210	0,3720	3	6	4020	8040	62	248	56	73
ZR-150 1500x310 - 300x1510	0,4650	3	6	5020	10040	62	248	57	74
ZR-150 1800x310 - 300x1810	0,5580	3	6	6030	12050	62	248	58	75
ZR-150 2000x310	0,6200	3	6	6700	13390	62	248	58	76
ZR-150 600x610	0,3660	3	6	3950	7910	62	248	56	73
ZR-150 900x610 - 600x910	0,5490	3	6	5930	11860	62	248	58	75
ZR-150 1200x610 - 600x1210	0,7320	3	6	7910	15810	62	248	59	76
ZR-150 1500x610 - 600x1210	0,9150	3	6	9880	19760	62	248	60	77
ZR-150 1800x610 - 600x1810	1,0980	3	6	11860	23720	62	248	61	78
ZR-150 2000x610	1,2200	3	6	13180	26350	62	248	61	79
ZR-150 900x910	0,8190	3	6	8850	17690	62	248	60	77
ZR-150 1200x910 - 900x1210	1,0920	3	6	11790	23590	62	248	61	78
ZR-150 1500x910 - 900x1510	1,3650	3	6	14740	29480	62	248	62	79
ZR-150 1800x910 - 900x1810	1,6380	3	6	17690	35380	62	248	63	80
ZR-150 2000x910	1,8200	3	6	19660	39310	62	248	63	80
ZR-150 1200x1210	1,4520	3	6	15680	31360	62	248	62	79
ZR-150 1500x1210 - 1200x1510	1,8150	3	6	19600	39200	62	248	63	80
ZR-150 1800x1210 - 1200x1810	2,1780	3	6	23520	47040	62	248	64	81
ZR-150 2000x1210	2,4200	3	6	26140	52270	62	248	64	82
ZR-150 1500x1510	2,2650	3	6	24460	48920	62	248	64	81
ZR-150 1800x1510 - 1500x1810	2,7180	3	6	29350	58710	62	248	65	82
ZR-150 2000x1510	3,0200	3	6	32620	65230	62	248	65	82
ZR-150 1800x1810	3,2580	3	6	35190	70370	62	248	66	83
ZR-150 2000x1810	3,6200	3	6	39100	78190	62	248	66	83
ZR-150 2000x1960	3,9200	3	6	42340	84670	62	248	66	84