



Range of centrifugal roof mounted fans in horizontal discharge format, suitable for many roof extract ventilation applications, including housing ventilation, commercial offices, etc...

**Description**

- Very low profile design.
- High efficiency centrifugal backward curved impeller and motor support manufactured from high strength black injection moulded plastic.
- Cowl manufactured from weatherproof injection moulded plastic.
- Bases manufactured from sheet steel protected by cataphoresis primer and black polyester paint coating.
- Supplied with IP65 remote terminal box and ON-OFF isolator switch.
- Fan speed adjustable with the potentiometer placed in the connection box or with an external control type REB ECOWATT.
- Analogical input with terminals in the connection box to control the fan with 0-10V input signal.



**IP65 remote terminal box**  
V0 fireproof plastic remote terminal box with built-in stop switch.



**High efficiency centrifugal backward impeller**  
Low maintenance and low consumption



**Patented design**  
High performance

**Motors**

Brushless EC high-efficient and low consumption motor, with external rotor, IP44.

Electrical supply 230V±10%/50-60Hz



**TECHNICAL CHARACTERISTICS**

Before installation check that the product electrical characteristics listed on the data plate label (voltage, power, frequency, etc.) match those of the intended electrical supply.

Model	Input tension regul. (V)	Speed (r.p.m.)	Maximum absorbed power (W)	Maximum absorbed current (A)	Maximum air volume (m³/h)	Sound pressure level* at 3 m (dB(A))		Working temperature (°C)	Weight (Kg)
						Inlet	Outlet		
TPSB-190/060 ECOWATT	10	3270	99	0,70	760	57	61	-20/+60	3,2
	8	3130	89	0,60	730	56	60		
	6	2650	55	0,40	620	52	57		
	4	2060	29	0,20	480	47	51		
TPSB-225/088 ECOWATT	10	2900	168	1,1	1.270	58	64	-20/+50	6,0
	8	2490	111	0,7	1.090	55	60		
	6	1940	56	0,4	850	49	53		
	4	1370	24	0,2	590	39	44		
TPSB-250/084 ECOWATT	10	2650	202	1,3	1.490	59	63	-20/+50	6,2
	8	2300	140	1,0	1.290	55	59		
	6	1800	73	0,6	1.000	49	53		
	4	1290	33	0,3	720	40	44		

\*Pipe fitting and mid-point measurement of the characteristic curve (points 2,5,8 and 11).

**DIMENSIONS (mm)**

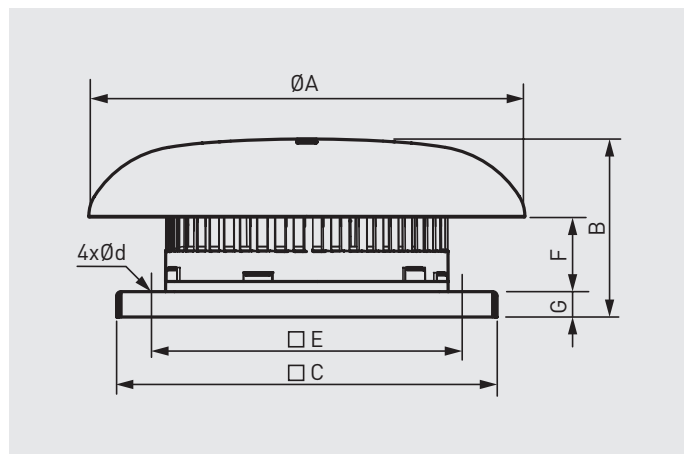

Model	A	B	C	D	E	F	G
TPSB-190/060 ECOWATT	344	141	300	10	245	59	20
TPSB-225/088 ECOWATT	452	186	435	10	330	87	20
TPSB-250/084 ECOWATT	452	182	435	10	330	83	20

**PERFORMANCE CURVES**

- $q_v$ : Airflow in  $m^3/h$ .
- $p_{sf}$ : Static pressure in Pa.
- SFP: Specific power factor, in  $W/m^3/s$  (blue curves).
- Dry air at  $20^\circ C$  and  $760$  mmHg.
- Performance data in accordance with ISO 5801 and AMCA 210-99 Standards.

TPSB-190/060 ECOWATT

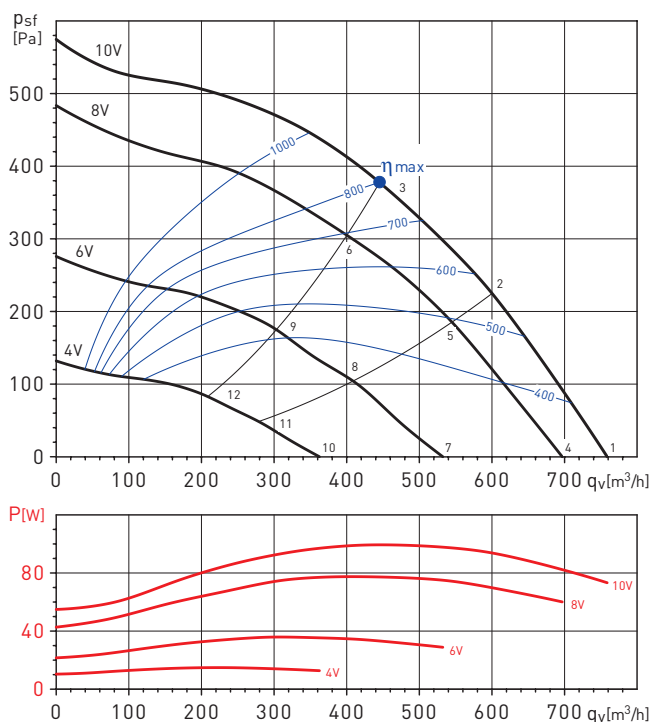

Power Spectra in dB (A)

Duty point		63	125	250	500	1.000	2.000	4.000	8.000	LwA
1	Inlet	33	44	57	70	73	72	69	60	77
	Outlet	41	45	59	71	76	79	72	64	82
2	Inlet	33	43	55	67	69	69	67	55	74
	Outlet	37	44	58	66	73	76	70	59	79
3	Inlet	34	44	58	67	70	67	63	54	74
	Outlet	36	47	60	69	74	74	66	55	78
4	Inlet	32	43	56	69	72	71	68	59	76
	Outlet	40	44	58	70	75	78	71	63	81
5	Inlet	32	42	54	66	68	68	66	54	73
	Outlet	36	43	57	65	72	75	69	58	78
6	Inlet	33	43	57	66	69	66	62	53	73
	Outlet	35	46	59	68	73	73	65	54	77
7	Inlet	28	39	52	65	68	67	64	55	73
	Outlet	36	40	54	66	71	74	67	59	77
8	Inlet	28	38	50	62	64	64	62	50	70
	Outlet	32	39	53	61	68	71	65	54	74
9	Inlet	29	39	53	62	65	62	58	49	69
	Outlet	31	42	55	64	69	69	61	50	73
10	Inlet	23	34	47	60	63	62	59	50	67
	Outlet	31	35	49	61	66	69	62	54	72
11	Inlet	23	33	45	57	59	59	57	45	64
	Outlet	27	34	48	56	63	66	60	49	69
12	Inlet	24	34	48	57	60	57	53	44	64
	Outlet	26	37	50	59	64	64	56	45	68

### PERFORMANCE CURVES

- $q_v$ : Airflow in  $m^3/h$ .
- $p_{sf}$ : Static pressure in Pa.
- SFP: Specific power factor, in  $W/m^3/s$  (blue curves).
- Dry air at  $20^\circ C$  and  $760$  mmHg.
- Performance data in accordance with ISO 5801 and AMCA 210-99 Standards.

TPSB-225/088 ECOWATT

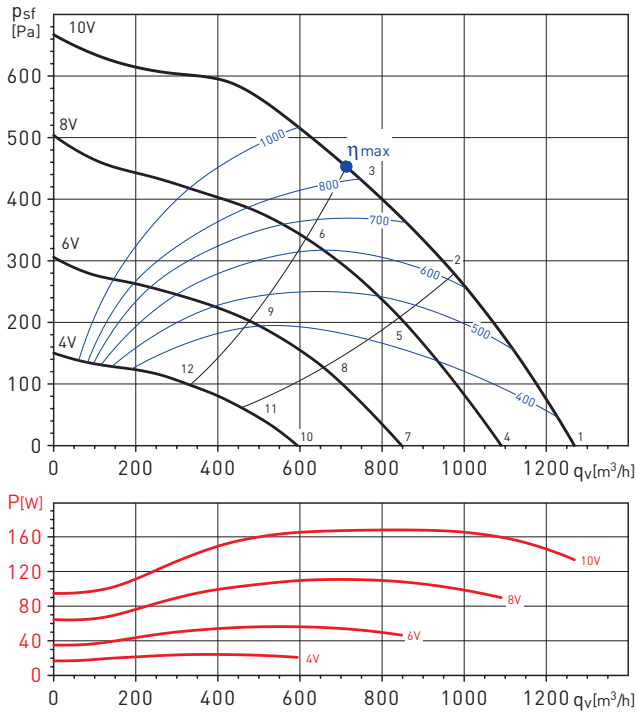

Power Spectra in dB (A)

Duty point		63	125	250	500	1.000	2.000	4.000	8.000	LwA
1	Inlet	41	50	60	68	72	71	71	64	77
	Outlet	50	54	71	73	80	82	76	71	85
2	Inlet	43	50	62	69	72	69	66	57	76
	Outlet	51	50	68	69	77	78	68	60	81
3	Inlet	47	55	69	73	75	69	63	54	78
	Outlet	52	57	71	74	79	78	68	61	83
4	Inlet	39	50	61	68	73	71	70	60	77
	Outlet	39	51	67	69	77	79	72	64	82
5	Inlet	37	47	59	65	69	66	62	52	72
	Outlet	37	47	64	65	74	74	64	55	78
6	Inlet	42	54	65	69	71	64	58	49	74
	Outlet	47	56	67	70	76	74	64	57	79
7	Inlet	37	46	55	62	67	65	62	50	71
	Outlet	36	47	59	63	71	73	65	54	76
8	Inlet	32	43	53	59	63	59	55	42	66
	Outlet	32	44	56	61	67	67	58	48	71
9	Inlet	37	53	58	62	64	57	50	38	67
	Outlet	39	55	60	63	68	66	55	49	71
10	Inlet	31	43	48	55	60	57	49	37	63
	Outlet	32	46	50	59	65	65	52	43	69
11	Inlet	27	40	45	51	53	49	42	28	57
	Outlet	27	43	46	53	58	58	43	41	62
12	Inlet	33	46	49	53	54	47	40	26	58
	Outlet	34	48	51	55	58	55	43	42	62

TPSB-250/084 ECOWATT

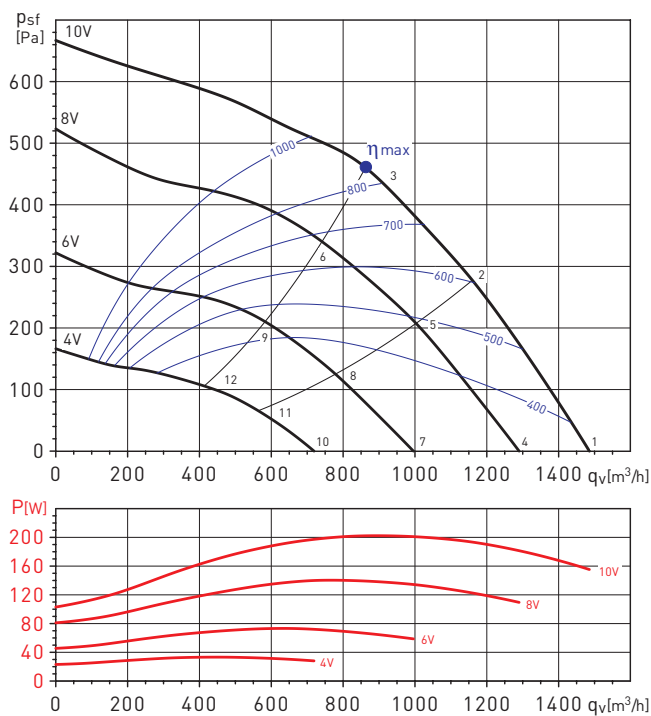

Power Spectra in dB (A)

Duty point		63	125	250	500	1.000	2.000	4.000	8.000	LwA
1	Inlet	41	53	72	72	76	73	77	64	82
	Outlet	44	54	72	73	81	80	76	68	85
2	Inlet	38	49	68	70	71	71	67	58	77
	Outlet	42	49	66	70	76	76	71	61	80
3	Inlet	40	52	65	71	72	68	63	58	76
	Outlet	42	53	66	70	77	75	66	59	80
4	Inlet	39	50	69	68	72	70	68	59	77
	Outlet	39	51	67	69	77	76	71	61	81
5	Inlet	35	46	63	65	68	66	62	53	72
	Outlet	36	47	62	65	73	72	66	56	77
6	Inlet	38	50	63	65	69	63	58	53	72
	Outlet	38	50	62	66	74	70	61	54	76
7	Inlet	37	47	61	63	65	63	60	48	70
	Outlet	37	49	60	63	70	70	63	52	74
8	Inlet	31	42	57	60	61	60	54	44	66
	Outlet	32	43	56	60	66	66	58	47	70
9	Inlet	34	47	57	60	62	56	51	45	66
	Outlet	35	48	57	61	66	62	53	45	69
10	Inlet	34	51	48	54	57	57	45	36	62
	Outlet	30	49	49	55	62	63	48	39	66
11	Inlet	29	48	47	50	53	50	40	32	57
	Outlet	27	49	46	51	58	58	43	34	62
12	Inlet	29	48	48	52	52	47	39	34	57
	Outlet	29	45	47	53	56	53	42	33	60

MOUNTING ACCESSORIES- INSTALLATION

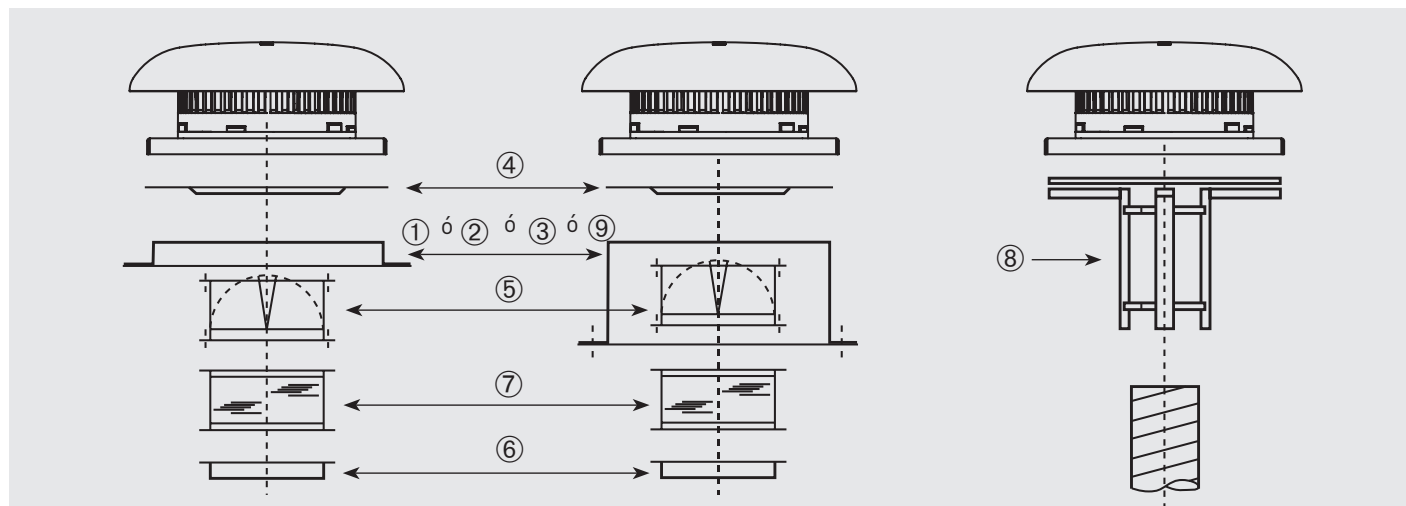

Model type	① Sealing frame	② Flat roof insulated up stand	③ Acoustic up stand	④ Accessory adapter plate	⑤ Backdraft shutter	⑥ Flange with spigot	⑦ Flexible couplig	⑧ Circular adapter	⑨ Support base for inclined curb mounted installations
TPSB-190/060 ECOWATT	JMS-300	JBS-300	JAA-300	JPA-300	JCA-300	JBR-300	JAЕ-300	JCC-300	BI-3
TPSB-225/088 ECOWATT	JMS-435	JBS-435	JAA-435	JPA-435	JCA-435	JBR-435	JAЕ-435	JCC-435	BI-4
TPSB-250/084 ECOWATT	JMS-435	JBS-435	JAA-435	JPA-435	JCA-435	JBR-435	JAЕ-435	JCC-435	BI-4

MOUNTING ACCESSORIES

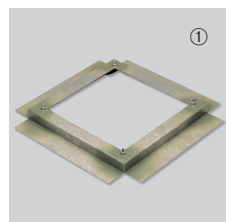

**JMS Sealing frame**  
 - For mounting a roof fan on an up stand or base.  
 - Supplied with screws and gasket for a complete weatherproof seal.

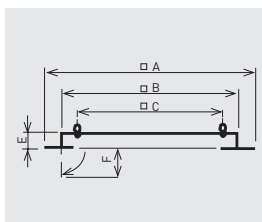

Model	□A	□B	□C	E	F
JMS-300	470	290	245	50	70
JMS-435	600	420	330	50	70



**JBS Flat roof up stand**  
 - For mounting a fan on a Rat roof without up stands.  
 - For use on horizontal roofs.  
 - Internal insulation to prevent condensation.  
 - Supplied with screws and gasket for a complete weather seal.

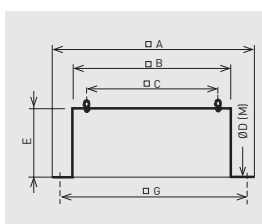

Model	□A	□B	□C	Ø D (M)	E	□G
JBS-300	470	289	245	10,5 (M8)	300	380
JBS-435	600	419	330	11 (M10)	300	510



**JPA Accessory adapter plate**  
 - Used when mounting the accessories (JCA, JBR, JAE).  
 - Allows the fan to be disconnected from the upstand without having to remove the duct.

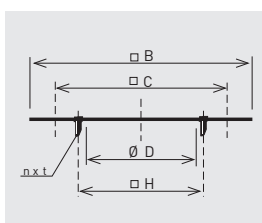

Model	□B	□C	Ø D	next	Ø H
JPA-300	289	245	182	4xM6	205
JPA-435	419	330	252	4xM8	280



**JCA Backdraft shutter**  
 - Prevents backdraft when the fan is not operating.  
 - To be mounted at the fan inlet with the JPA plate.

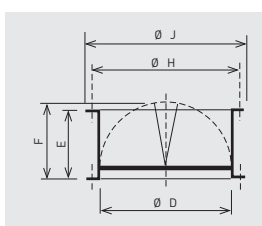

Model	Ø D	E	F	Ø H	Ø J
JCA-300	182	100	124	205	219
JCA-435	252	145	174	280	300

**MOUNTING ACCESSORIES**



**JBR N Flange**

- For use when circular connection is required directly to the fan.
- To be mounted at the fan inlet with the JPA plate or Cxed directly to the fan base (rivets or screws not supplied).

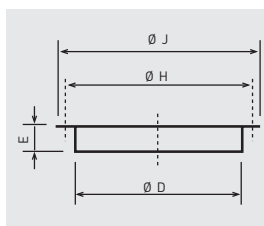

Model	Ø D	E	Ø H	Ø J
JBR-300 N	182	55	205	219
JBR-435 N	252	55	280	300

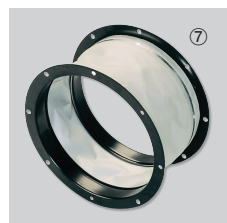

**JAE N Flexible coupling**

- Reduces the transmission of vibrations when the duct is connected directly to the fan.
- To be mounted at the fan inlet with JPA plate.

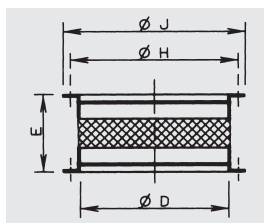

Model	Ø D	E	Ø H	Ø J
JAE-300 N	182	164	205	219
JAE-435 N	252	164	280	300



**JCC Adapter for circular duct**

- For use when fitting the models up to 400, directly to a spirally wound circular duct.

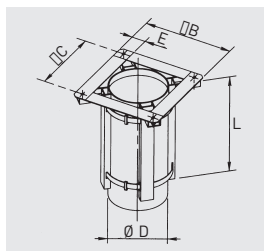

Model	Ø B	Ø C	Ø D	E	L
JCC-300	290	245	180	45	350
JCC-435	390	330	250	60	350



**BI Support base for inclined curb mounted installations**

- To ensure a proper installation of the CRHB-CRHT roof fan it is essential to specify the roof pitch angle and the distance between the roof beam profiles.

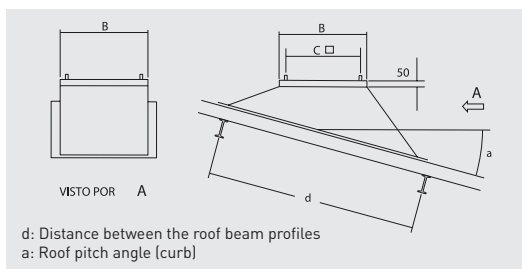

	B	C
BI-3	289	245
BI-4	419	330



**JAA Acoustic up stand**

- Reduces in duct and radiated noise.
- For use when mounting a fan on a Rat roof without up stands.
- Supplied with screws and gasket for a complete weather seal

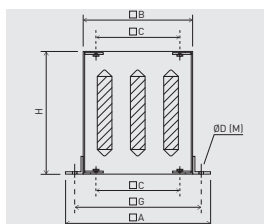

Model	Ø A	Ø B	Ø C	Ø D (M)	H	Ø G
JAA-300	470	290	245	13 (M10)	750	380
JAA-435	600	419	330	15 (M12)	750	510

Acoustic attenuation in dB (A) per frequency band in Hz.

Model	125	250	500	1000	2000	4000	8000
JAA-300	1	5	13	22	23	16	12
JAA-435	1	7	16	23	25	18	13

**ELECTRICAL ACCESORIES**



**AIRSENS-CO2**  
**AIRSENS-VOC**  
**AIRSENS-RH**  
Intelligent IAQ sensors that detect the concentration of CO<sub>2</sub> or VOC or HR.



**CONTROL-ECOWATT AC/DC**  
Control element for demand controlled ventilation system.



**CONTROL-ECOWATT BASIC**  
Speed controller and stop/start.



**REB-ECOWATT**  
Speed controller.



**SCO2-AD**  
CO<sub>2</sub> and temperature sensor, with display.  
**SCHT-AD**  
CO<sub>2</sub> sensor, temperature and relative humidity with display.



**CPTA-S/CPTA-E**  
Presence detector.



**TDP-S / TDP-D / TDP-PI**  
Pressure sensor.



**REMP**  
Motorised damper.