



Cabinet fans with integrated, low-pressure drop filters, manufactured from galvanised sheet steel and internally isolated with 30 mm thick fireproof acoustic mineral wool (M0), airtight intake and discharge joints, easy access to filters by rotary traction type closures. Equipped with backward curved centrifugal impellers. Brushless, high performance and low consumption EC motor, 230V ± 10% 50/60Hz power supply, IP44, ball bearings, thermal protection, ON/OFF switch with built-in potentiometer to adjust speed and analogue input 0-10V signal to control the fan. All models have the capacity to mount up to 3 filters.

Filters

- F7 Version: Supplied with F7 filter. It is possible to add a second high-efficiency filter and a pre-filter, both accessories.
- Version with F7 filter + F9 filter.

It is possible to add a pre-filter (accessory).

High-efficiency filter assembly system with clamping arms which allows the adaption to one or two filters. Thanks to the threaded knobs, it is possible to tight the union between the filter and frame well, minimising the external air by-pass comparing with the usual filter in a guide mounted filters.

It is recommended to add a pre-filter (G4 or M5 supplied as accessory) to extend the useful service life of the high-efficiency filters.

Filtration efficiency according to ISO-16890 of F7+F9 version
 ePM10 = 99.5%, ePM2.5 = 98.5%, ePM1 = 96.2%.

Other data

They can be placed in any position. Designed for indoor installations. Working temperature from -20 °C to +40 °C.

High-efficiency filters and very low-pressure loss.



Terminal box with built-in ON/OFF switch

From UVF-400/160 to UVF-1100/250 models, the terminal box is remote, with a 650 mm length cable. All models include a potentiometer inside the terminal box, which allows manual speed adjustment.

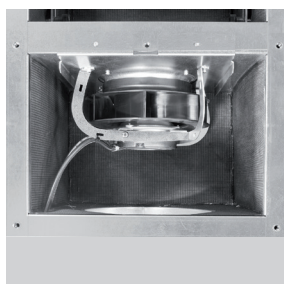

Low noise level

Lined with 30 mm thick fireproof acoustic fiberglass insulation (M0) and high-strength coating, which reduces noise significantly.



3-filter capacity

High-efficiency filter mounting system with clamping arms that can be adapted to the thickness of one or two filters one or two filter thicknesses.

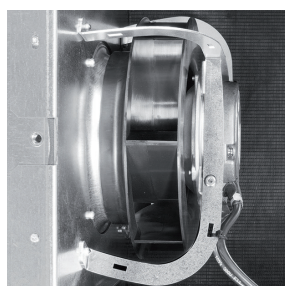

Centrifugal fan with backward curved blades and EC motor

Includes external pressure taps to help control the fan at a constant flow (accessories required).



Pressure switch included

A pressure switch is supplied with the product. Once connected to the pressure taps on the unit, filter contamination can be controlled.

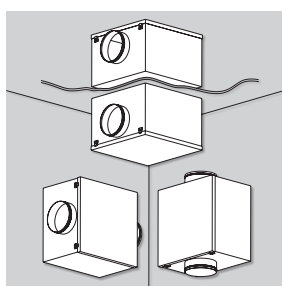

Install in any position

They can be installed in vertical, horizontal or inverted positions.



LOW CONSUMPTION ACOUSTIC CABINET FANS WITH INTEGRATED FILTER

UVF ECOWATT Series



TECHNICAL CHARACTERISTICS

Before installation, check that the product's electrical characteristics listed on the rating plate label (voltage, power, frequency, etc.) match those of the intended installation's electrical supply.

Model	Speed (r.p.m.)	Power supply	Maximum absorbed power (W)	Maximum absorbed current (A)	Maximum airflow* (m³/h)	Sound pressure level** (dB(A) at 1,5 m)			Weight (kg)
						Inlet	Outlet	Breakout	
UVF-400/160 ECOWATT	3900	230V/I/50-60Hz	100	0,5	390	49	49	38	13
UVF-600/200 ECOWATT	3300	230V/I/50-60Hz	115	0,57	590	47	47	40	18
UVF-1100/250 ECOWATT	2800	230V/I/50-60Hz	210	1,1	1.050	52	51	41	21
UVF-1500/315 ECOWATT	2300	230V/I/50-60Hz	235	1,4	1.460	48	48	43	28
UVF-2500/355 ECOWATT	1900	230V/I/50-60Hz	355	1,39	2.460	55	53	45	37
UVF-3000/400 ECOWATT	1800	230V/I/50-60Hz	360	1,45	2.700	52	51	45	39

* With F7 filter.

** At 70% of maximum airflow with F7 filter.

FILTRATION EFFICACY BASED ON THE COMBINATION OF FILTERS USED. ACCORDING TO ISO-16890

Filter combination	Filtration efficiency s/ISO-16890*		
	ePM10	ePM2,5	ePM1
M5	55%	-	-
F7	90%	83%	75%
F9	95%	91%	85%
M5+F7	95,5%	83%	75%
M5+F9	97,7%	91%	85%
F7+F9	99,5%	98,5%	96,2%

* Considering filters at mid-life of its service life.

Accessory filters needed depending on the required filter combination

From a UVF F7 version

Model Cabinet fan model	Filter combination required			Pre-filter
	F7	M5+F7	F7+F9	G4
UVF-400/160 F7 ECOWATT	Included	AFR UVF-400 M5	AFR UVF-400 F9	AFR UVF-400 G4
UVF-600/200 F7 ECOWATT	Included	AFR UVF-600 M5	AFR UVF-600 F9	AFR UVF-600 G4
UVF-1100/250 F7 ECOWATT	Included	AFR UVF-1100 M5	AFR UVF-1100 F9	AFR UVF-1100 G4
UVF-1500/315 F7 ECOWATT	Included	AFR UVF-1500 M5	AFR UVF-1500 F9	AFR UVF-1500 G4
UVF-2500/355 F7 ECOWATT	Included	AFR UVF-2500/3000 M5	AFR UVF-2500/3000 F9	AFR UVF-2500/3000 G4
UVF-3000/400 F7 ECOWATT	Included	AFR UVF-2500/3000 M5	AFR UVF-2500/3000 F9	AFR UVF-2500/3000 G4

From a UVF F7+F9 version

Model Cabinet fan model	Filter combination required	Pre-filter
	F7+F9	G4
UVF-400/160 F7+F9 ECOWATT	Included	AFR UVF-400 G4
UVF-600/200 F7+F9 ECOWATT	Included	AFR UVF-600 G4
UVF-1100/250 F7+F9 ECOWATT	Included	AFR UVF-1100 G4
UVF-1500/315 F7+F9 ECOWATT	Included	AFR UVF-1500 G4
UVF-2500/355 F7+F9 ECOWATT	Included	AFR UVF-2500/3000 G4
UVF-3000/400 F7+F9 ECOWATT	Included	AFR UVF-2500/3000 G4

DIMENSIONS (mm)

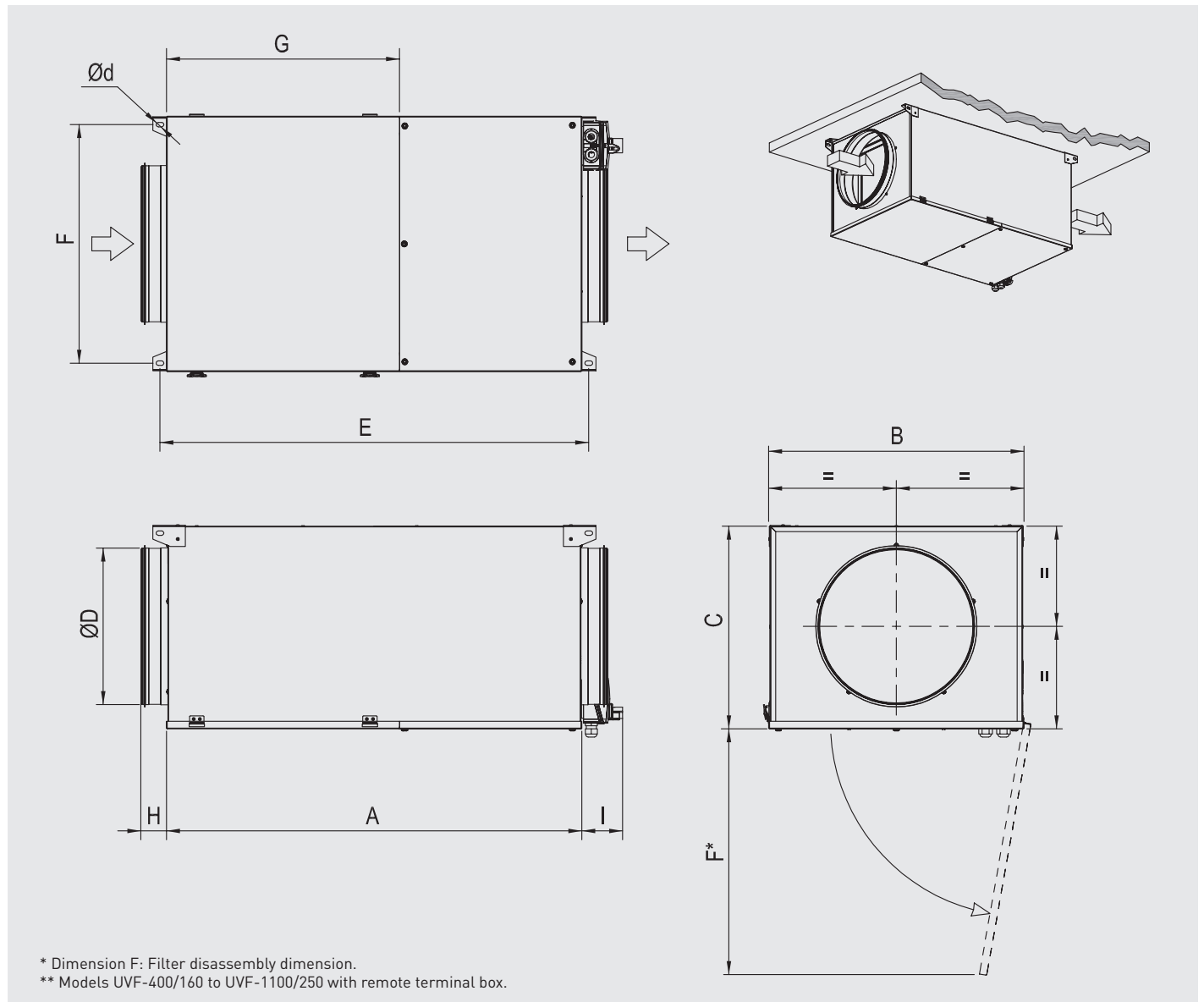

Model	A	B	C	D	E	F	d	G	H	I
UVF-400/160 ECOWATT	692	313	259	160	718	278	9	468	52	52**
UVF-600/200 ECOWATT	728	363	309	200	754	350	9	468	52	52**
UVF-1100/250 ECOWATT	770	413	334	250	795	400	9	468	52	52**
UVF-1500/315 ECOWATT	836	513	409	315	862	500	9	468	52	77
UVF-2500/355 ECOWATT	932	613	459	355	957	600	9	468	52	77
UVF-3000/400 ECOWATT	932	613	459	400	957	600	9	468	52	77

PERFORMANCE CURVE CHARACTERISTICS

- q_v = Airflow in m^3/h .
- p_{sf} = Static pressure in mmcd and Pa.
- SFP: Specific fan power in $W/m^3/s$ (blue curves).
- Normal dry air at $20^\circ C$ and 760 mmHg.
- Performance data according to ISO 5801 and AMCA 210-99.

F7 Version

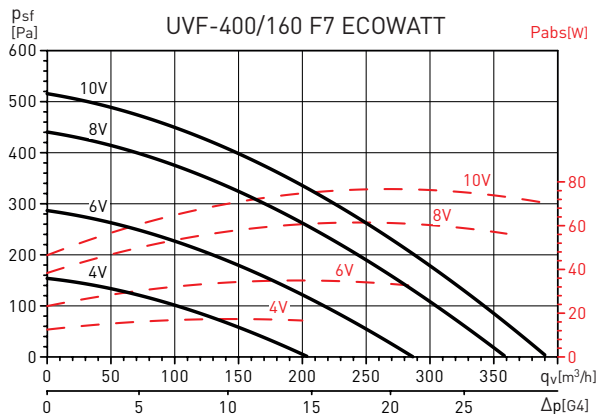

F7 Version

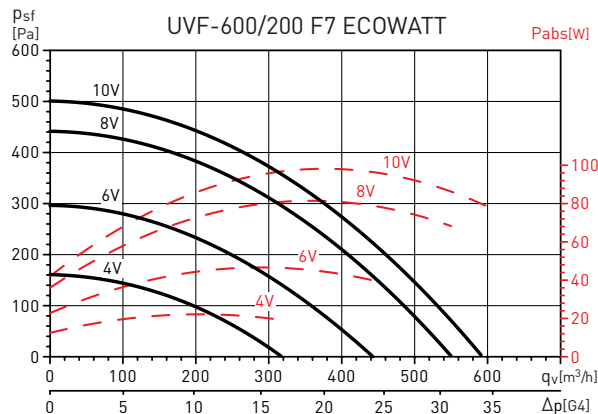

F7+F9 Version

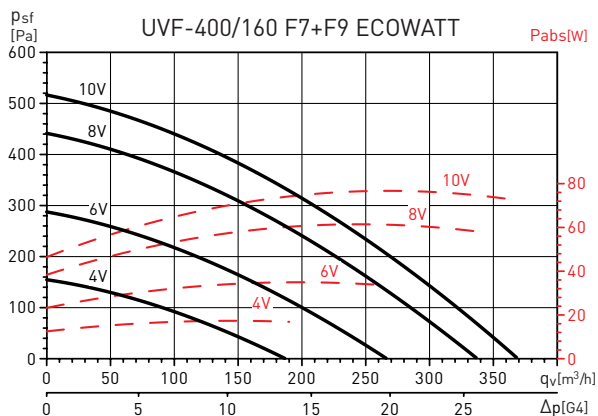

F7+F9 Version

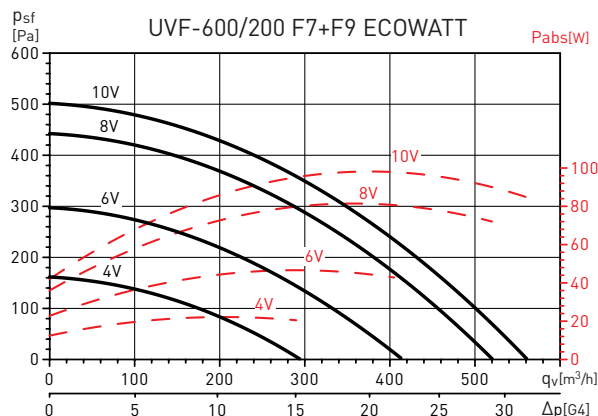

F7+M5 Version (accessory)

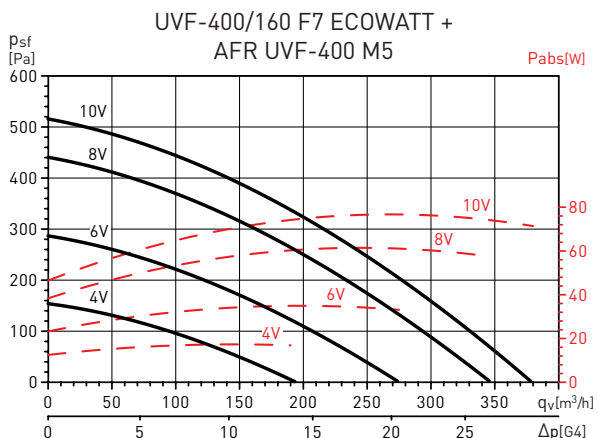

F7+M5 Version (accessory)

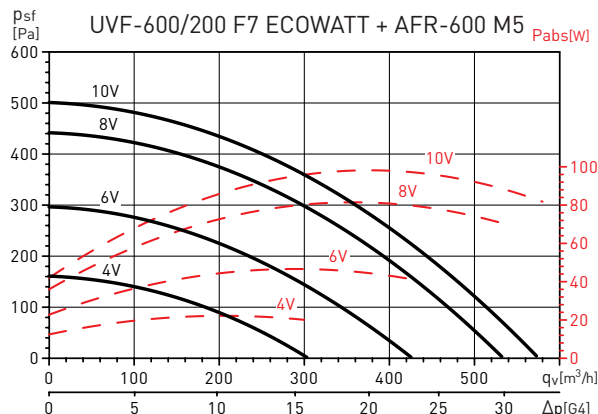

PERFORMANCE CURVE CHARACTERISTICS

- q_v = Airflow in m^3/h .
- p_{sf} = Static pressure in mmcda and Pa.
- SFP: Specific fan power in $W/m^3/s$ (blue curves).
- Normal dry air at 20°C and 760 mmHg.
- Performance data according to ISO 5801 and AMCA 210-99.

F7 Version

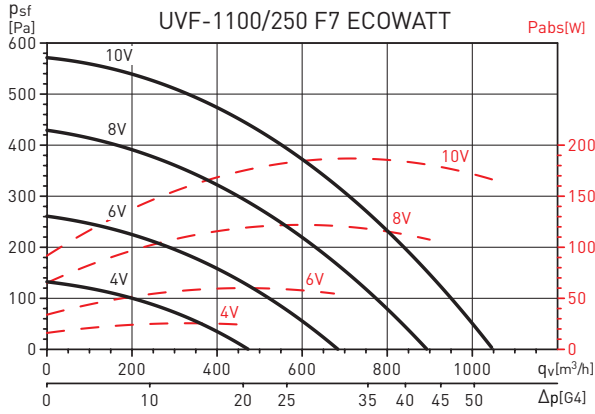

F7 Version

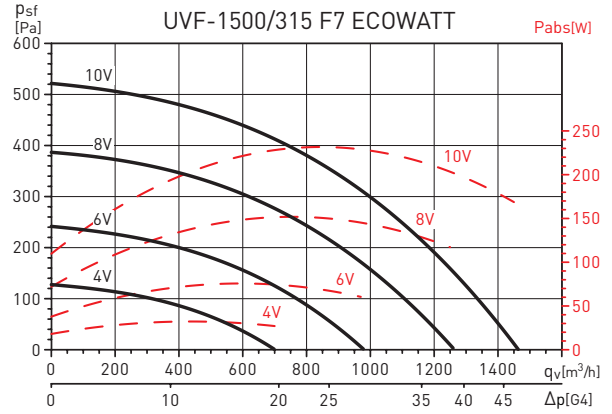

F7+F9 Version

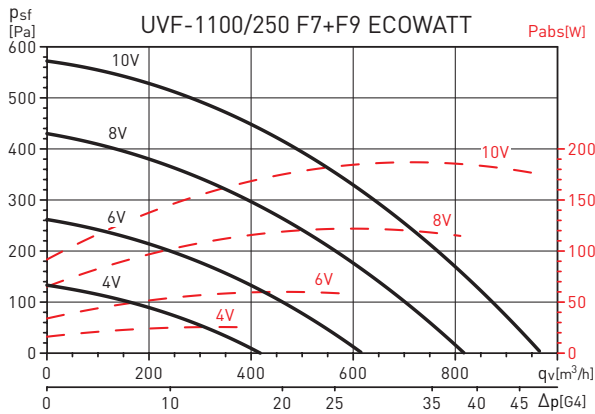

F7+F9 Version

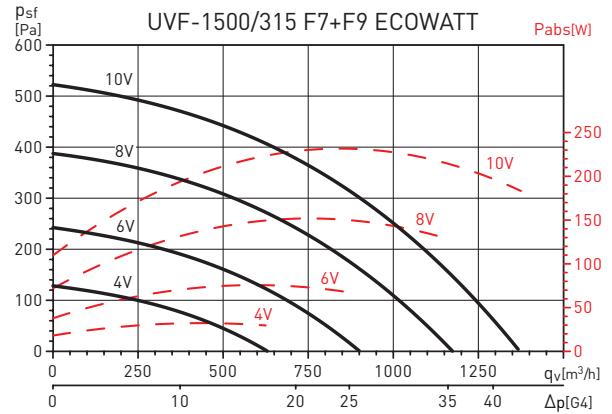

F7+M5 Version (accessory)

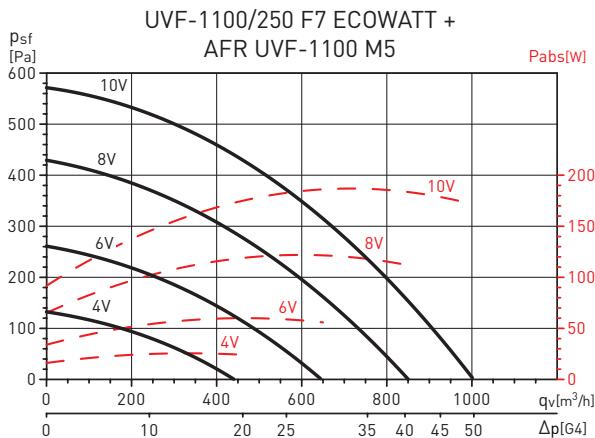

F7+M5 Version (accessory)

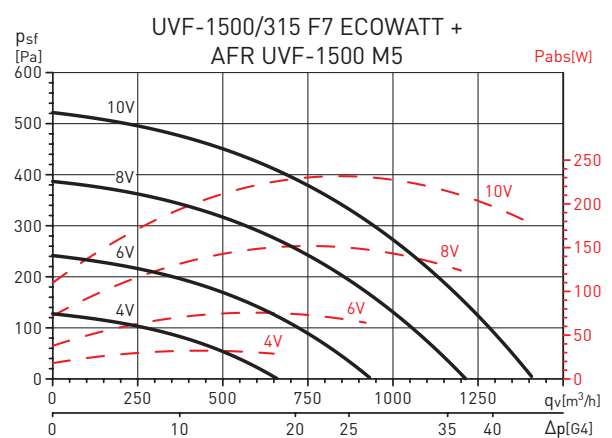

PERFORMANCE CURVE CHARACTERISTICS

- q_v = Airflow in m^3/h .
- p_{sf} = Static pressure in mmcda and Pa.
- SFP: Specific fan power in $W/m^3/s$ (blue curves).
- Normal dry air at 20°C and 760 mmHg.
- Performance data according to ISO 5801 and AMCA 210-99.

F7 Version

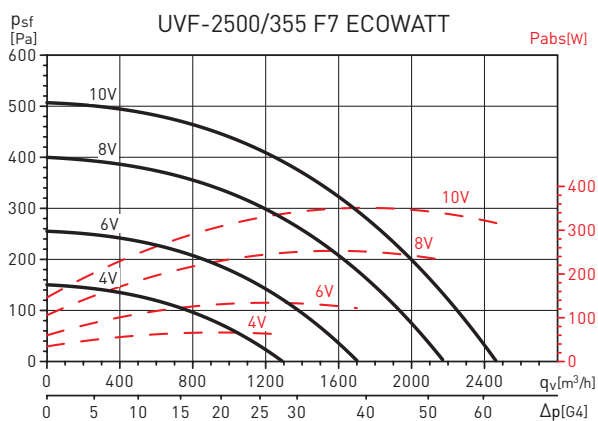

F7 Version

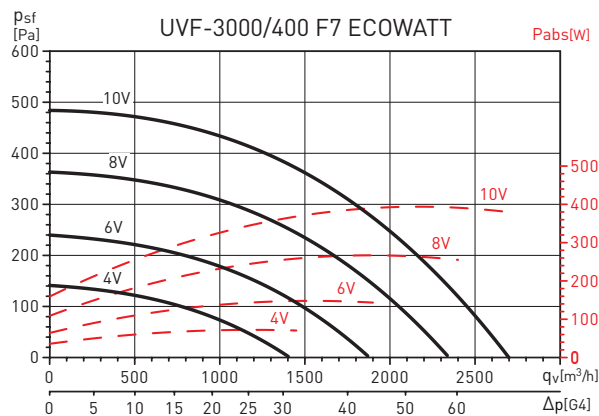

F7+F9 Version

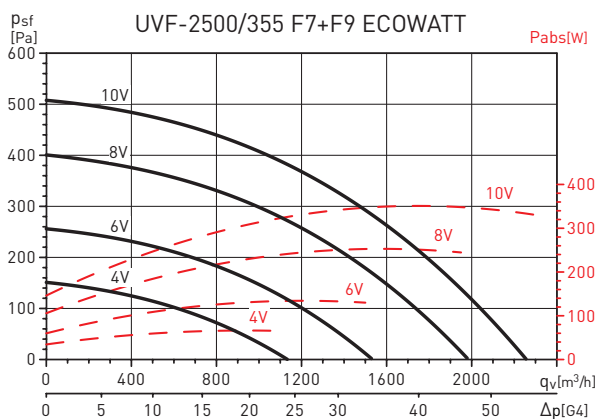

F7+F9 Version

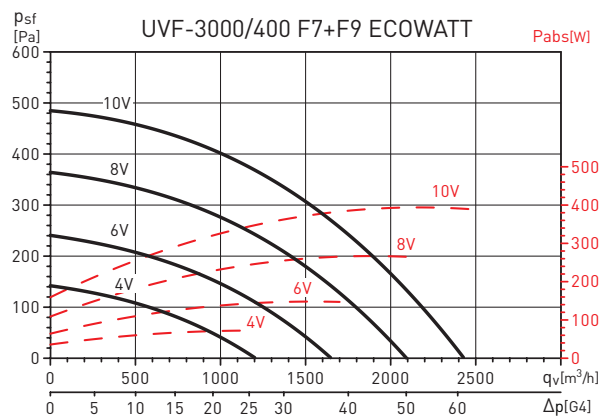

F7+M5 Version (accessory)

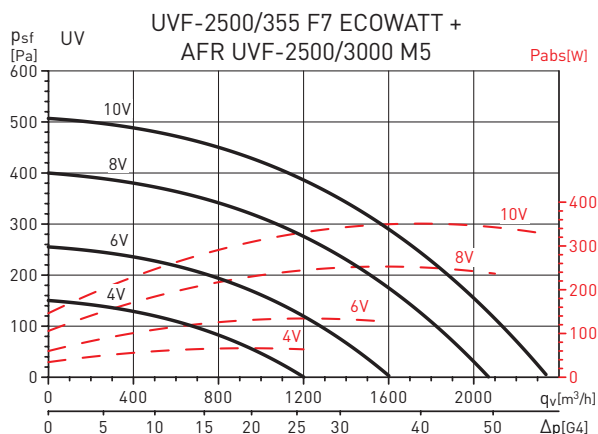

F7+M5 Version (accessory)

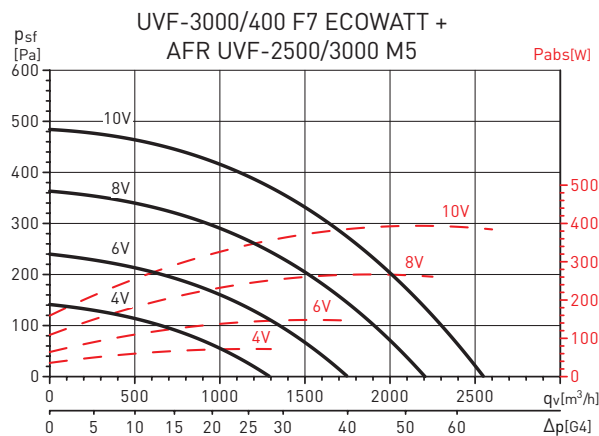

MOUNTING ACCESSORIES

Model	Ø Inlet/Outlet	SIL	APC	CAR	Circular flexible connector
		Silencer	Air intake and output	Non-return damper	
UVF-400/160 ECOWATT	160	SIL-160	APC-160	CAR-160	ACOPEL F400-160N
UVF-600/200 ECOWATT	200	SIL-200	APC-200	CAR-200	ACOPEL F400-200N
UVF-1100/250 ECOWATT	250	SIL-250	APC-250	CAR-250	ACOPEL F400-250N
UVF-1500/315 ECOWATT	315	SIL-315	APC-315	CAR-315	ACOPEL F400-315N
UVF-2500/355 ECOWATT	355	SIL-355	APC-355	CAR-355	ACOPEL F400-355N
UVF-3000/400 ECOWATT	400	SIL-400	APC-400	CAR-400	ACOPEL F400-400N

ELECTRICAL ACCESSORIES

Fan control accessories

Model	Manual speed regulation		Caudal Variable por CO ₂		Constant pressure / Constant flow	
	Internal potentiometer	External potentiometer	Controller	Sensor	Controller	Sensor
UVF-400/160 ECOWATT	Included	REB-ECOWATT	CONTROL AERO-REG	AIRSENS CO2/SC02-AD/ SC02-G	CONTROL AERO-REG	TDP-D
UVF-600/200 ECOWATT	Included	REB-ECOWATT	CONTROL AERO-REG	AIRSENS CO2/SC02-AD/ SC02-G	CONTROL AERO-REG	TDP-D
UVF-1100/250 ECOWATT	Included	REB-ECOWATT	CONTROL AERO-REG	AIRSENS CO2/SC02-AD/ SC02-G	CONTROL AERO-REG	TDP-D
UVF-1500/315 ECOWATT	Included	REB-ECOWATT	CONTROL AERO-REG	AIRSENS CO2/SC02-AD/ SC02-G	CONTROL AERO-REG	TDP-D
UVF-2500/355 ECOWATT	Included	REB-ECOWATT	CONTROL AERO-REG	AIRSENS CO2/SC02-AD/ SC02-G	CONTROL AERO-REG	TDP-D
UVF-3000/400 ECOWATT	Included	REB-ECOWATT	CONTROL AERO-REG	AIRSENS CO2/SC02-AD/ SC02-G	CONTROL AERO-REG	TDP-D

MOUNTING ACCESSORIES



ACOPEL F400 N
Circular flexible couplings.



KSE-45
Rubber anti-vibration supports that dampen vibrations and reduce the installation's noise level.
(1KSE = 4 supports per bag)

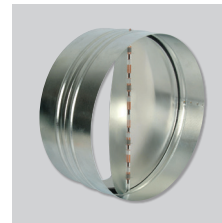

CAR
Non-return damper.



APC
Discharge protective guard.

SPARE FILTERS

Model	G4	M5	F7	F9	Number of filters	Dimensions (mm)
UVF-400/160 ECOWATT	AFR UVF-400 G4	AFR UVF-400 M5	AFR UVF-400 F7	AFR UVF-400 F9	1	300x250x48
UVF-600/200 ECOWATT	AFR UVF-600 G4	AFR UVF-600 M5	AFR UVF-600 F7	AFR UVF-600 F9	1	350x300x48
UVF-1100/250 ECOWATT	AFR UVF-1100 G4	AFR UVF-1100 M5	AFR UVF-1100 F7	AFR UVF-1100 F9	1	400x325x48
UVF-1500/315 ECOWATT	AFR UVF-1500 G4	AFR UVF-1500 M5	AFR UVF-1500 F7	AFR UVF-1500 F9	1	500x400x48
UVF-2500/355 ECOWATT	AFR UVF-2500/3000 G4	AFR UVF-2500/3000 M5	AFR UVF-2500/3000 F7	AFR UVF-2500/3000 F9	1	600x450x48
UVF-3000/400 ECOWATT	AFR UVF-2500/3000 G4	AFR UVF-2500/3000 M5	AFR UVF-2500/3000 F7	AFR UVF-2500/3000 F9	1	600x450x48

ELECTRICAL ACCESSORIES



CONTROL AERO-REG

Specific accessory to control the ventilation part of the UVF-ECOWATT and UTBS-ECOWATT fan units. It is supplied as an accessory (wiring and installation not included).

Functions:

- Stop-start.
- Manual-automatic motor speed regulation.
- Filter dirt detector by the pressure switch included in the UVF-ECOWATT.
- Fan breakdown detector is necessary to install a DPS 2.30 pressure switch, not included in the control supply.
- Communication through protocol ModBus.

Operation:

- Manual potentiometer: manual fan speed control through the potentiometer mounted on the front of the device.
- Proportional: analogue input (0-10V/4-20mA). Control of fan speeds from a CO₂, relative humidity or temperature sensor's signal (accessory).
- Proportional Integral PI: Constant pressure system control. A TDP-D pressure sensor (accessory) is needed.

Model	Power supply	Maximum current Regulated AC Output (A)	Output voltage	IP Protection	Working temperature	Dimensions LxAxH (mm)
CONTROL AERO-REG	230 VAC	11	0-10VDC / 110-230VAC	IP55	-10°C a +50°C	175x250x120



REB-ECOWATT

Speed controller.



SC02-AD

CO₂ and temperature sensor. With display.



SC02-G 0/10V

CO₂ conduit sensor. It allows fan control according to the CO₂ concentration in the air circulating through the exhaust duct. Outlet: 0-10V. Power supply: 24 VDC.



AIRSENS-CO2

Indoor air quality control element that includes an internal CO₂ sensor. Specially designed to create DCV systems directly connected with single-phase fans or ECOWATT depending on whether the control output is through relay or analogue signal.



TDP-D

Pressure transmitter.