



CAB ECOWATT PLUS



ES EN FR NL



ÍNDICE

1. GENERALIDADES.....	4
2. NORMAS DE SEGURIDAD Y MARCADO CE.....	4
3. NORMAS GENERALES.....	4
4. DESCRIPCIÓN.....	5
4.1. Ubicaciones.....	5
4.2. Conexionado eléctrico y detalle placa interna.....	6
5. FUNCIONAMIENTO SIN CONSOLA PROSYS ECOWATT.....	7
6. FUNCIONAMIENTO CON ACCESORIO CONSOLA PROSYS ECOWATT.....	7
6.1. Descripción.....	8
6.2. Utilización de la consola.....	8
6.3. Instalación.....	9
6.4. Parámetros generales.....	12
6.5. Puesta en marcha del sistema.....	12
6.6. Configuración de los equipos a través de la consola.....	13
6.6.1. Modificación consigna.....	13
6.6.2. Cambio modo funcionamiento.....	13
6.6.3. Funcionamiento modo PI PRESION (COP).....	14
6.6.4. Funcionamiento modo PI CAUDAL/CAV.....	17
6.6.5. Funcionamiento modo PROPORCIONAL/VAV.....	21
6.6.6. Funcionamiento modo MIN/MAX.....	24
7. FUNCIONAMIENTO CON ACCESORIO PROGRAMADOR HORARIO TIMER RTC ECOWATT MAS PROSYS ECOWATT.....	26
7.1. Instalación.....	26
7.2. Programación.....	27
7.3. Tabla resumen valores de ajuste.....	30
8. INTEGRACIÓN A SISTEMA DE COMUNICACIÓN MODBUS.....	30
8.1. Características básicas del control Modbus-RTU.....	30
8.2. Mapa de memoria Modbus.....	31
9. MANTENIMIENTO.....	34
10. RECICLAJE.....	34

1. GENERALIDADES

Le agradecemos la confianza depositada en **S&P** mediante la compra de este producto, que ha sido fabricado según reglas técnicas de seguridad, conforme a las normas de la **CE**.

Antes de instalar y poner en funcionamiento este producto, lea atentamente el presente libro de instrucciones pues contiene indicaciones importantes para su seguridad y la de los usuarios durante la instalación, uso y mantenimiento de este producto. Una vez finalizada la instalación, entrégueselas al usuario final.

Compruebe el perfecto estado del aparato al desembalarlo ya que cualquier defecto de origen que presente está amparado por la garantía **S&P**. Asimismo, compruebe que el aparato es el que usted ha solicitado y que los datos que figuran en la placa de instrucciones coincidan con sus necesidades.

2. NORMAS DE SEGURIDAD Y MARCADO “CE”

Los técnicos de **S&P** están firmemente comprometidos en la investigación y desarrollo de productos cada vez más eficientes y que cumplan con las normas de seguridad en vigor.

Las normas y recomendaciones mencionadas, reflejan las normas vigentes, preferentemente en materia de seguridad y por lo tanto se basan principalmente en el cumplimiento de las normas de carácter general. Por consiguiente, recomendamos a todas las personas expuestas a riesgos que se atengan escrupulosamente a las normas de prevención de accidentes en vigor en su país.

S&P queda eximido de cualquier responsabilidad por eventuales daños causados a personas y cosas derivados de la falta de cumplimiento de las normas de seguridad, así como de posibles modificaciones en el producto.

El sello **CE** y la correspondiente declaración de conformidad, atestiguan la conformidad con las normas comunitarias aplicables.

3. NORMAS GENERALES

Se ha realizado el análisis de los riesgos del producto como está previsto en la Directiva de Máquinas.

Este manual contiene toda la información destinada a todo el personal expuesto, con el fin de prevenir posibles daños a personas y/o cosas, a causa de una defectuosa manipulación o mantenimiento.

Todas las intervenciones de mantenimiento (ordinario y extraordinario) deben ser realizadas con la máquina parada y alimentación eléctrica desconectada.

Antes de conectar el cable de alimentación eléctrica a la regleta, verifique que la tensión de la línea corresponde a la indicada en la placa de características de la unidad.

El cable de alimentación eléctrica deberá pasar dos veces, mediante una lazada, por la ferrita WE74271221 añadida en el embalaje.



4. DESCRIPCIÓN

4.1. UBICACIONES

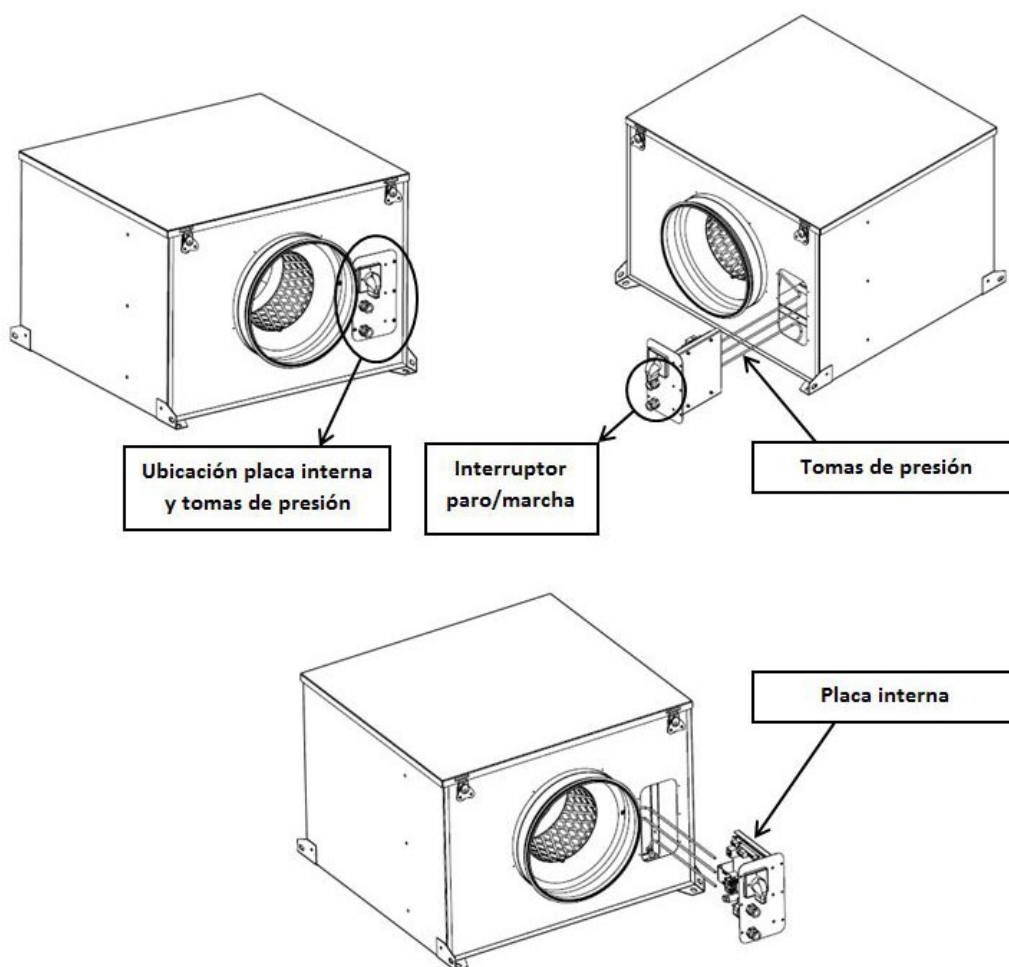

IMPORTANTE

En el espacio donde se encuentra la placa interna se pueden observar tres tubos marcados como "V", "P-" y "P+" procedentes del interior de la caja de ventilación. De fábrica se sirven con el tubo marcado como "P-" conectado. Mantener de esta forma salvo haber leído previamente el apartado 6.6.3. de estas instrucciones.

4.2. CONEXIONADO ELÉCTRICO Y DETALLE PLACA INTERNA

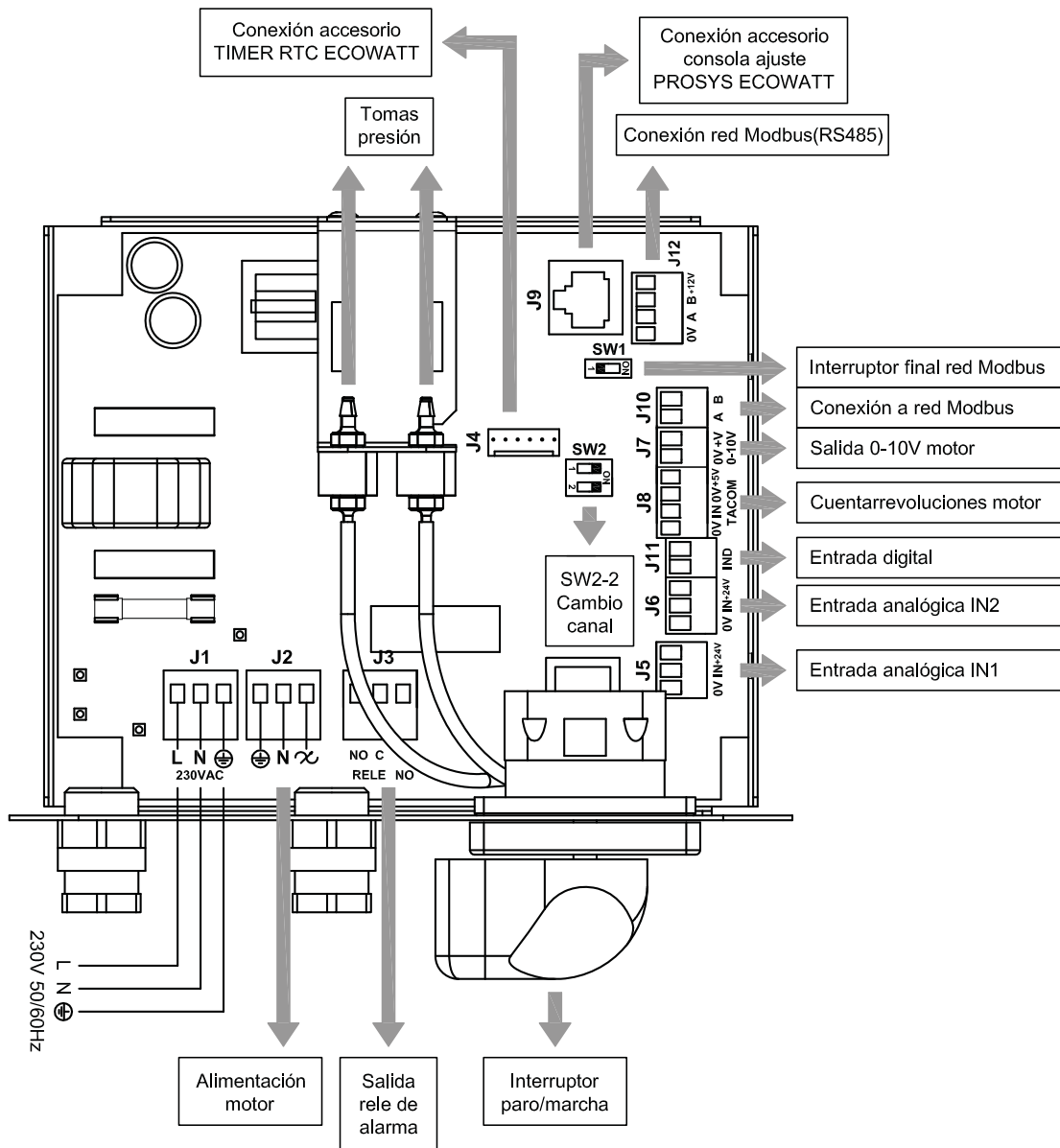

Entradas	Descripción
L, N, GND (J1)	Alimentación eléctrica. 220-230 V AC 50 Hz
Toma presión 1	Toma para conectar conducto presión según modo funcionamiento
Toma presión 2	
Conector (J4)	Entrada para conexión con accesorio programador horario TIMER RTC ECOWATT
0V, IN, +24V (J5)	Entrada Analógica IN1 4-20 mA ó 0-10V
0V, IN, +24V (J6)	Entrada Analógica IN2 4-20 mA ó 0-10V
RJ45 (J9)	Entrada para conexión con accesorio control remoto PROSYS ECOWATT
IND (J11)	Entrada Digital para función noche o modo funcionamiento MIN/MAX. En estado abierto el ventilador pasa a velocidad noche o velocidad mínima cuando el contacto se cierra. En estado cerrado el ventilador pasa a velocidad noche o velocidad mínima cuando el contacto se abre.

Salidas	Descripción
GND, N, N (J2)	Alimentación placa interna pasando por el interruptor (cableado en fábrica)
RELÉ (J3)	Conmuta con la activación de cualquier alarma (carga máxima 2A)
0V, +V (J7)	Salida analógica 0-10V hacia motor
TACOM (J8)	Cuenta revoluciones motor
A, B (J10)	Conexión a red de comunicación. Protocolo Modbus
RS485 (J12)	Conexión a red de comunicación. Protocolo Modbus

Micro interruptores	Descripción
SW1	Resistencia final de línea. Uso exclusivo en redes de comunicación Modbus
SW2	SW2-2: habilitar cambio canal

5. FUNCIONAMIENTO SIN CONSOLA PROSYS ECOWATT

La caja de ventilación CAB-ECOWATT PLUS está preparada para que el ventilador trabaje en modo presión constante (PI PRESION/COP) respecto a una lectura de diferencia de presión realizada sobre la aspiración y una consigna preseleccionada de fábrica.

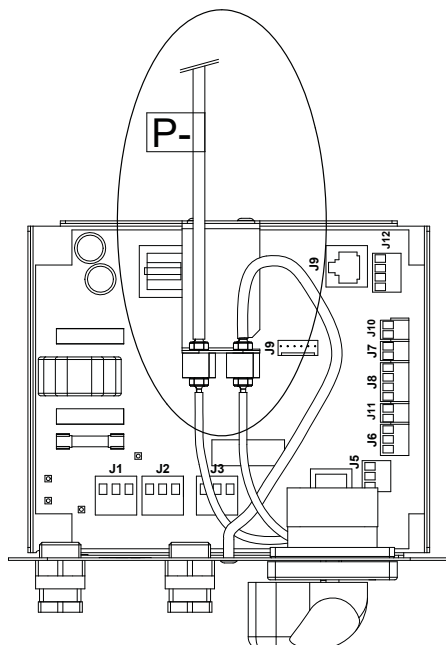

Presión constante (aspiración) por defecto

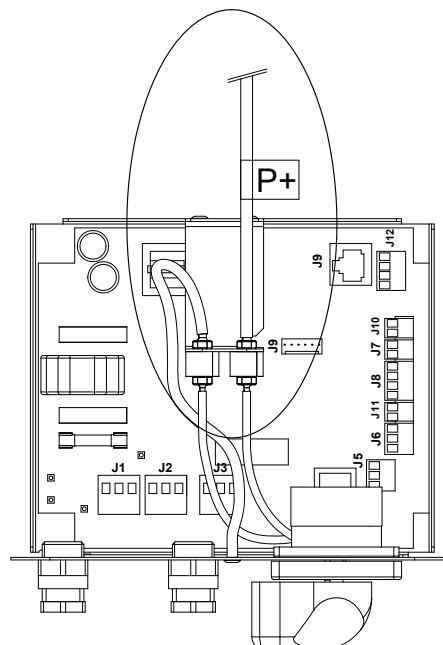

Presión constante (descarga)

Tabla presión consigna

Modelo	Consigna (Pa)
125	100
150	150
160	150
200	150
250	150
315	150
355	200
400	200

La configuración de fábrica es para que la presión constante se realice sobre la aspiración. No obstante, también es posible realizara mediante la descarga.

6. FUNCIONAMIENTO CON ACCESORIO CONSOLA PROSYS ECOWATT

Adquiriendo la consola PROSYS ECOWATT ofrecida como accesorio, se tendrá acceso a los modos de funcionamiento siguientes:

- **Sistema de presión constante (PI PRESION/COP)** con parámetros de consigna modificables.
- **Sistema de caudal de aire constante (PI CAUDAL/CAV)** con parámetros de consigna modificables.
- **Sistema de caudal de aire variable (PROPORCIONAL/VAV)** (es necesario instalar una sonda externa emisora de señal analógica 0-10V o 4-20mA).
- **Sistema funcionamiento MIN/MAX** (es necesario instalar sonda emisora señal digital, reloj horario o contacto exterior).



PROSYS ECOWATT

6.1. DESCRIPCIÓN

La consola PROSYS ECOWATT se utiliza como complemento de visualización y control. Permite realizar las siguientes funciones:

- Visualizar los parámetros y las variables del equipo
- Guardar configuraciones
- Visualizar configuraciones
- Configurar el equipo y modos de funcionamiento
- Buscar equipos (canales) a la red (previamente deben haber sido configurados con números de canales distintos)

La consola dispone de un visualizador LCD de 2x16 caracteres, 4 pulsadores y 3 LED's.

- Pulsador "Arriba"
- Pulsador "Abajo"
- Pulsador "+"
- Pulsador "-"
- LED alimentación ON
- LED "actividad" Modbus
- LED error

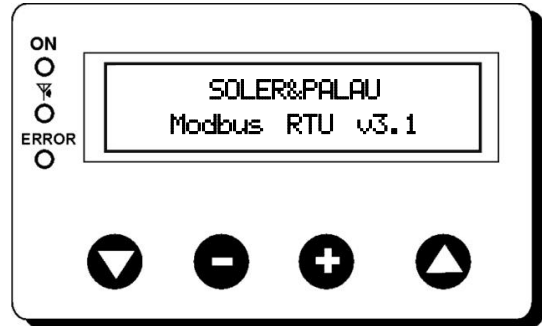

6.2. UTILIZACIÓN DE LA CONSOLA

Cuando se modifica un parámetro configurado, los pulsadores de la consola tienen las siguientes funciones:

Pulsador	Función
+	Incrementa valor del parámetro
-	Disminuye valor del parámetro
▲	Enter
▼	Salir

Cuando se navega por los menús la función del pulsador es distinta y depende de las indicaciones existentes en la pantalla. Cada pulsador realiza las funciones indicadas justo sobre él.

Ejemplos:

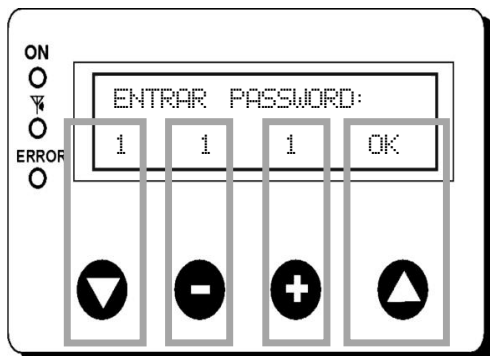

Pulsador	Función
▼	Modifica el valor del 1º dígito
-	Modifica el valor del 2º dígito
+	Modifica el valor del 3º dígito
▲	OK. Validar

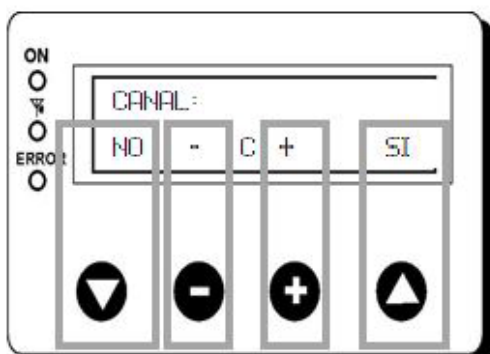

Pulsador	Función
▼	NO = Salir
-	Reduce el valor del canal
+	Incrementa el valor del canal
▲	SI = Validar

6.3. INSTALACIÓN

Es posible instalar una sola consola PROSYS ECOWATT a un CAB ECOWATT PLUS, o bien realizar una red de comunicación Modbus uniendo varias cajas de ventilación a una única consola PROSYS.

Esquema de conexión control individual

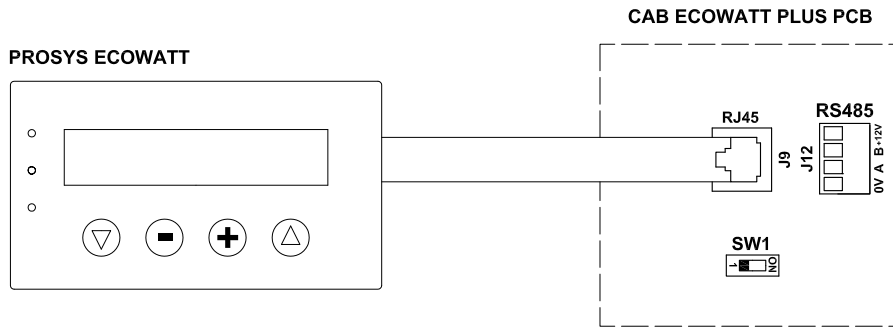

Esquema de conexión control múltiple

Es posible conectar hasta 32 ventiladores entre ellos para crear una red que pueda ser ajustada y controlada con una sola consola PROSYS ECOWATT.

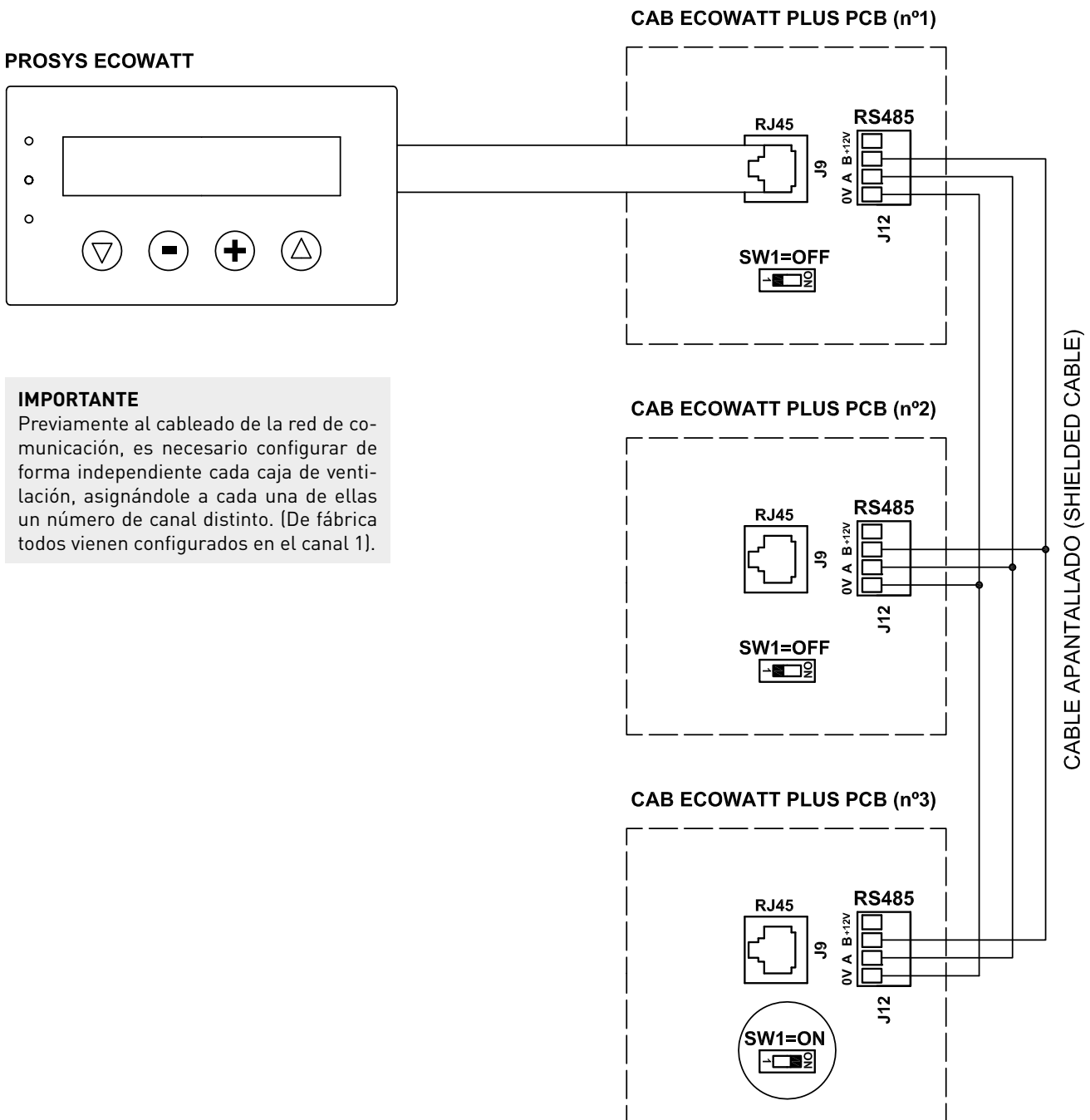

IMPORTANTE
 Previamente al cableado de la red de comunicación, es necesario configurar de forma independiente cada caja de ventilación, asignándole a cada una de ellas un número de canal distinto. (De fábrica todos vienen configurados en el canal 1).

Para realizar el cambio de asignación de canal al ventilador se deberán seguir los pasos siguientes:

- Comprobar que el interruptor paro/marcha esté en posición "0"
- Acceder a la placa interna y posicionar el micro interruptor SW2-2 en "ON"
- Conectar la consola PROSYS ECOWATT a la placa interna mediante el conector J9
- Encender el equipo mediante el interruptor paro/marcha
- Elegir el idioma deseado en la pantalla inicial
- Avanzar por las pantallas de la consola de la forma siguiente:

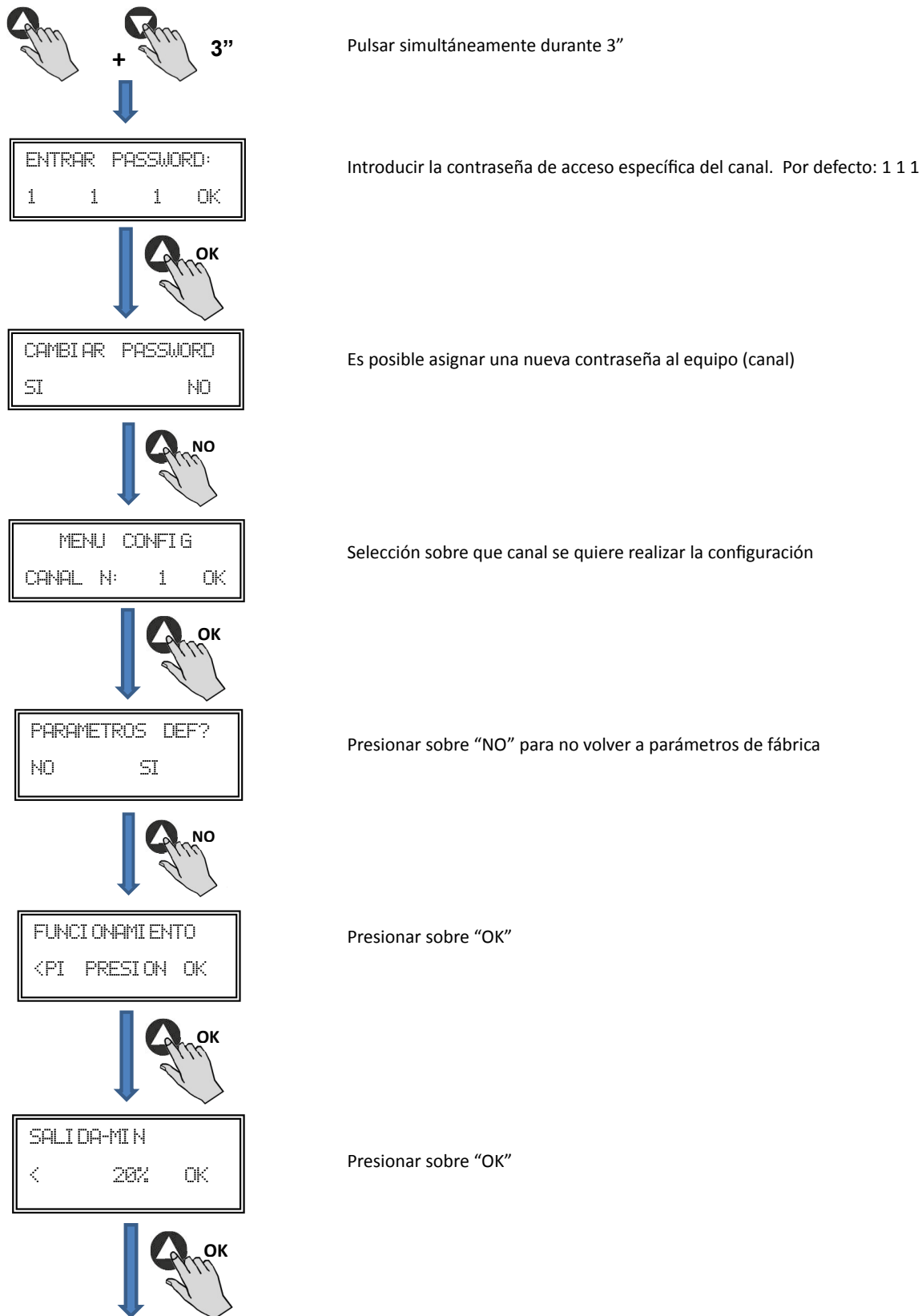



Presionar sobre "OK"

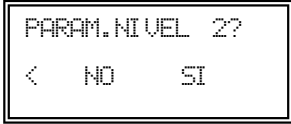
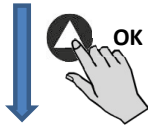

Presionar sobre "NO"

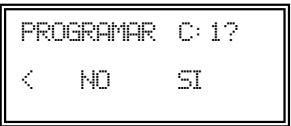
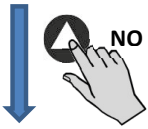

Presionar sobre "SI" para guardar cambios

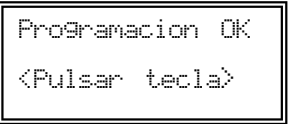
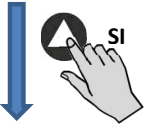

Apretar cualquier tecla para volver a la pantalla inicial



- Apagar el equipo mediante el interruptor paro/marca posición "0".
- Volver a acceder a la placa interna y posicionar el micro interruptor SW2-2 en "OFF".
- El cambio del número del ventilador quedará realizado al volver a encender el equipo.

Estando la consola PROSYS ECOWATT conectada sobre el equipo master, acceder a cada unidad numerada anteriormente mediante la pantalla de cambio de canal. Acceder a ella presionando la tecla  de forma repetitiva desde la pantalla inicial.

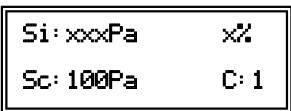

Pantalla inicial

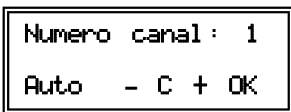
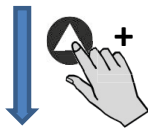

Pantalla cambio canal

6.4. PARÁMETROS GENERALES

Una vez realizado el conexionado, alimentar el sistema mediante el interruptor paro/marcha. Al conectar el equipo aparecerá la siguiente pantalla:



Una vez elegido el idioma, aparece una pantalla con la siguiente información:

Si: xxxPa	x%
Sc: 100Pa	C: 1

- Si: xxx** Valor medido (las unidades dependerán del modo de funcionamiento)
- Sp/Sc: xxx** Consigna programada
- X%** Velocidad ventilador en % (sobre velocidad máxima)
- C: 1** Núm. ventilador si conectado a red

Pulsando la tecla se puede acceder a la segunda pantalla de información:

RPM: xxx	InD: 0
Rele: 0	C: 1

- RPM: xxx** Núm. revoluciones ventilador (se requiere bornes TACOM conectados)
- Rele: 0** Indica si la salida de relé de alarma está conectada (0: salida sin conexión; 1: salida conectada)
- InD: 0** Entrada digital (J11 función noche o Min/Max)(0: salida sin conexión; 1: salida conectada)
- C: 1** Canal de comunicación utilizado (de 1 a 247)

6.5. PUESTA EN MARCHA DEL SISTEMA

Una vez realizado el conexionado y configuración, se debe proceder a la alimentación del sistema. Al conectar el equipo aparecerá la pantalla inicial con la versión del software, al cabo de 3 segundos se iniciará la conexión. Si la conexión se efectúa con éxito aparecerá la primera pantalla de información. La pantalla correspondiente a control PI PRESION es la que aparecerá por defecto:

Control PI PRESION/COP	Control PI CAUDAL/CAV
Si: 100 Pa 100%	Si: 100 m ³ /h 100%
Sp: 100 Pa C:1	Sp: 100 m ³ /h C:1
Control PROPORCIONAL/VAV	Control MIN-MAX
S2: 30%HR 21%	INLD: ON 21%
C:1	C:1

6.6. CONFIGURACIÓN DE LOS EQUIPOS A TRAVÉS DE LA CONSOLA

6.6.1. Modificación consigna

Una vez elegido el idioma, aparece una pantalla con la siguiente información:

Si: XXX	x%
Sc: XXX	C:1

- Si: xxx** Valor medido (las unidades dependerán del modo de funcionamiento)
- Sc: xxx** Consigna
- X%** Velocidad ventilador en % (sobre velocidad máxima)
- C: 1** Núm. equipo si conectado a red

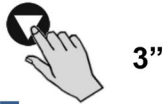

3"

Pulsar durante 3"



CONSIGNA CONSOLA:		
XXX XXX	OK	

Pulsar o para modificar manualmente la consigna



6.6.2. Cambio modo funcionamiento

Una vez alimentada la caja de ventilación, escogido el idioma deseado y estando la consola visualizando una de las pantallas de visualización descritas con anterioridad, realizar la siguiente secuencia:

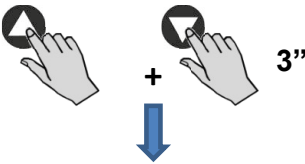

3"

Pulsar simultáneamente durante 3"



ENTRAR PASSWORD:			
1	1	1	OK

Introducir la contraseña de acceso específica del canal.
Por defecto: 1 1 1

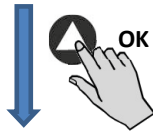

CAMBIAR PASSWORD	
SI	NO

Es posible asignar una nueva contraseña al equipo (canal)

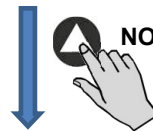

MENU CONFIG		
CANAL N:	1	OK

Selección sobre qué canal se quiere realizar la configuración

En este momento nos encontramos en modo configuración y ya es posible navegar por los parámetros del equipo, configurando el modo de trabajo:

PARAMETROS DEF?
NO SI

Presionando sobre "SI", se vuelve a cargar la configuración de fábrica

FUNCIONAMIENTO
<PI PRESION OK

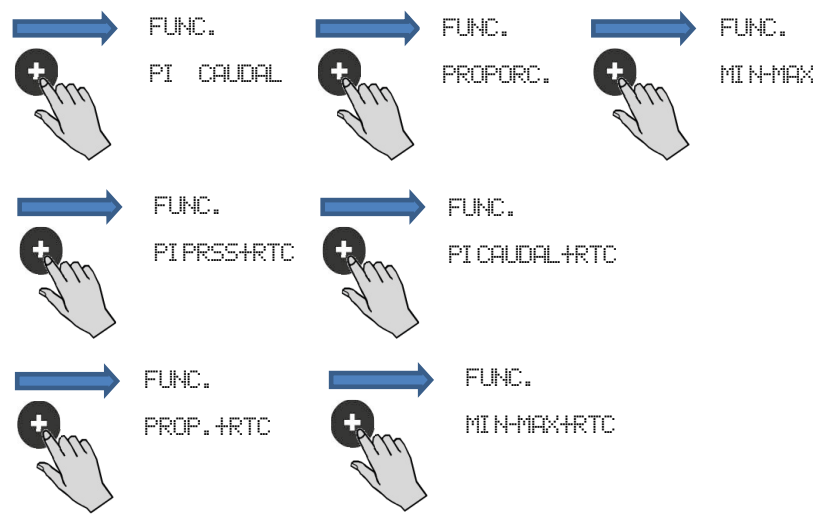

Funcionamiento: En función del modo seleccionado, los parámetros visualizados serán los específicos de cada modo. Modos acabados en RTC sólo en combinación con el accesorio programador horario TIMER RTC.

6.6.3. Funcionamiento modo PI PRESION (COP)

En el apartado 5 se ha descrito que el ventilador viene preparado para trabajar en modo presión constante utilizando un sensor de presión incorporado en la caja de control. No obstante, también es posible la conexión de un transductor de presión externo (0-10V o 4-20mA) que se debería conectar a los bornes J5 o J6.

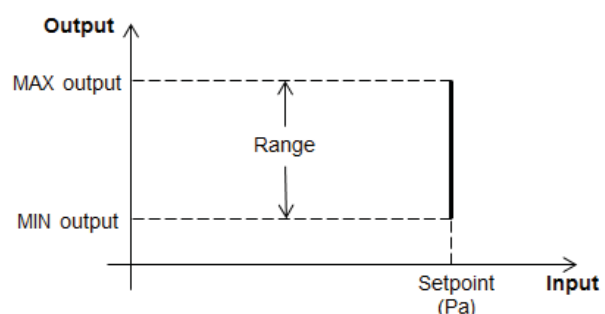

Funcionamiento Modo PI CAUDAL/COP

Una vez seleccionado el modo de funcionamiento PI PRESION, se podrán configurar los siguientes parámetros:

SALIDA-MIN
< 20% OK

Pulsar **+** o **-** para modificar manualmente el parámetro de salida mínima a motor

SALIDA-MAX
< 100% OK

Pulsar **+** o **-** para modificar manualmente el parámetro de salida máxima a motor

SALIDA-MAX
< 100% OK

PARAM. NIVEL 2?
< NO SI

Acceso a configuración de parámetros avanzados

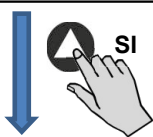

ENTRAR PASSWORD:
1 1 1 OK

Introducir la contraseña de acceso específica del canal.
Por defecto: 1 1 1



CAMBIAR PASSWORD
SI NO

Es posible asignar una nueva contraseña al equipo (canal)

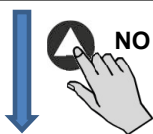

TIPO MOTOR
< EC OK

No modificar



SENSOR
< INTERNO OK



SENSOR
< IN1 0-10V OK



SENSOR
< IN1 4-20mA OK

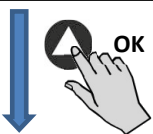

SENSOR
< IN2 0-10V OK



SENSOR
< IN2 4-20mA OK

Sensor: Tipo de sensor

- **INTERNO:** Sonda diferencial de presión interna
- **IN1 0-10V:** Sonda externa señal analógica 0-10V (terminal J5)
- **IN1 4-20mA:** Sonda externa señal analógica 4-20mA (terminal J5)
- **IN2 0-10V:** Sonda externa señal analógica 0-10V (terminal J6)
- **IN2 4-20mA:** Sonda externa señal analógica 4-20mA (terminal J6)

RANGO
< 400Pa OK

Pulsar o para modificar manualmente el parámetro. El valor que aparece en pantalla corresponde a la escala del sensor interno preajustado en fábrica. Si se instala un sensor externo, introducir el rango de escala correspondiente.



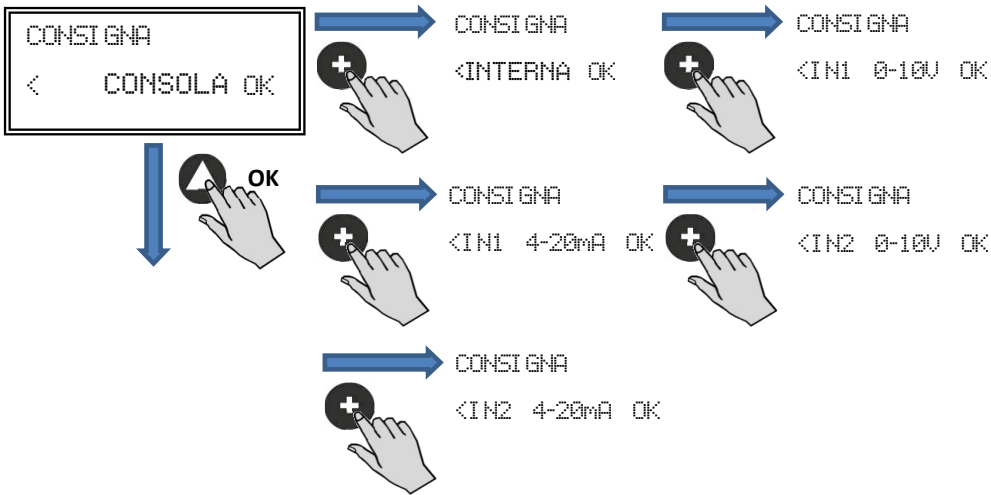

Consigna:

- **INTERNA**
- **CONSOLA:** Valor ajustado mediante consola PROSYS ECOWATT. Valor definido de fábrica
- **IN1/IN2 0-10V:** Valor ajustado mediante potenciómetro externo (0-10V)
- **IN1/IN2 4-20mA:** Valor ajustado mediante potenciómetro externo (4-20mA)

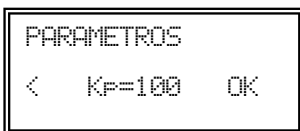

Pulsar **+** o **-** para modificar manualmente el parámetro. **Se aconseja no modificar.**

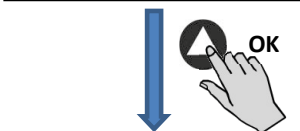

Pulsar **+** o **-** para modificar manualmente el parámetro. **Se aconseja no modificar.**

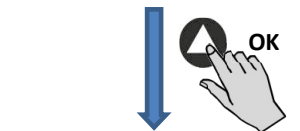
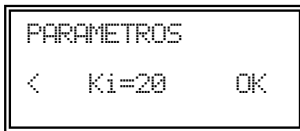

Pulsar **+** o **-** para modificar manualmente el parámetro. **Se aconseja no modificar.**

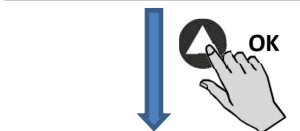
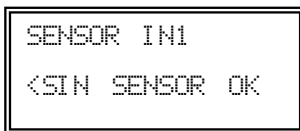

Pulsar **+** o **-** para modificar manualmente el parámetro. Este valor corresponde al % sobre la presión de consigna estando el ventilador en posición noche. Para ello se puede conectar un reloj o interruptor libre de potencial en la entrada digital J11

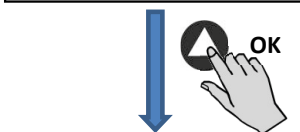
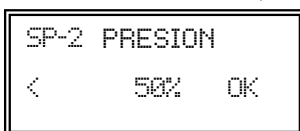

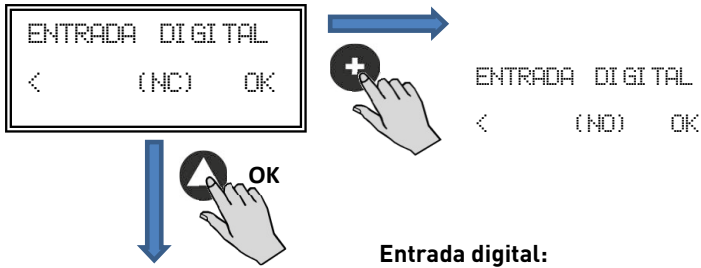

Entrada digital:

- **NC:** Contacto normalmente cerrado. El ventilador pasa a posición noche cuando el contacto se abre.
- **NO:** Contacto normalmente abierto. El ventilador pasa a posición noche cuando el contacto se cierra.



Pulsar **+** o **-** para modificar manualmente el parámetro que permite visualizar la velocidad del motor mediante la salida J8 (TACOM). **Se aconseja no modificar valor por defecto.**

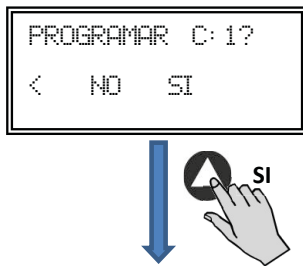

Guardar en memoria parámetros modificados

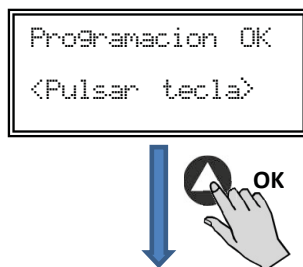

Apretar cualquier tecla para volver a la pantalla inicial

6.6.4. Funcionamiento modo PI CAUDAL/CAV

Primeramente, antes de seleccionar el modo funcionamiento PI CAUDAL mediante la consola PROSYS ECOWATT, es necesario realizar la correcta conexión de tubos de presión. Colocar los tubos marcados como "V" y "P-" tal y como se representa a continuación (el modelo CAB-125 ECOWATT no dispone del modo función PI CAUDAL/CAV).

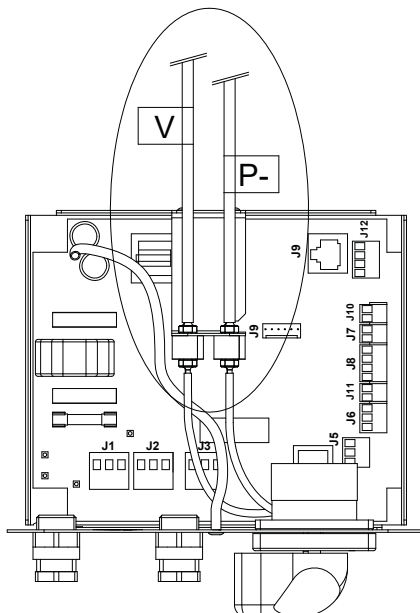

Caudal constante (aspiración)

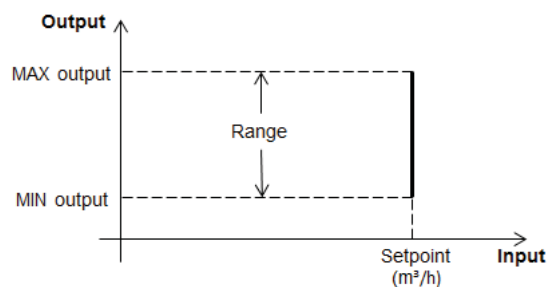

Caudal constante

Una vez cambiado el modo de funcionamiento a PI CAUDAL, aparecerán los parámetros siguientes:

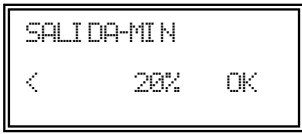

Pulsar **+** o **-** para modificar manualmente el parámetro de salida mínima a motor

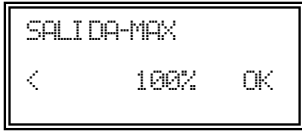
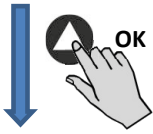

Pulsar **+** o **-** para modificar manualmente el parámetro de salida máxima a motor

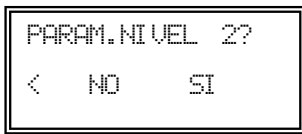
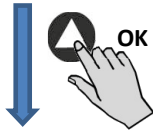

Acceso a configuración de parámetros avanzados

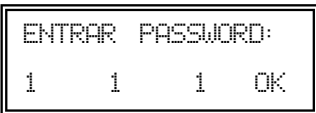
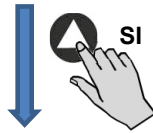

Introducir la contraseña de acceso específica del canal.
Por defecto: 1 1 1

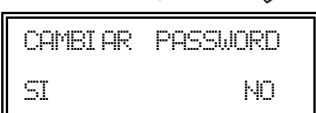
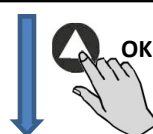

Es posible asignar una nueva contraseña al equipo (canal)

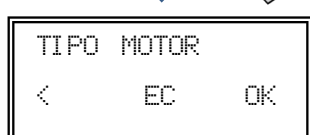

No modificar



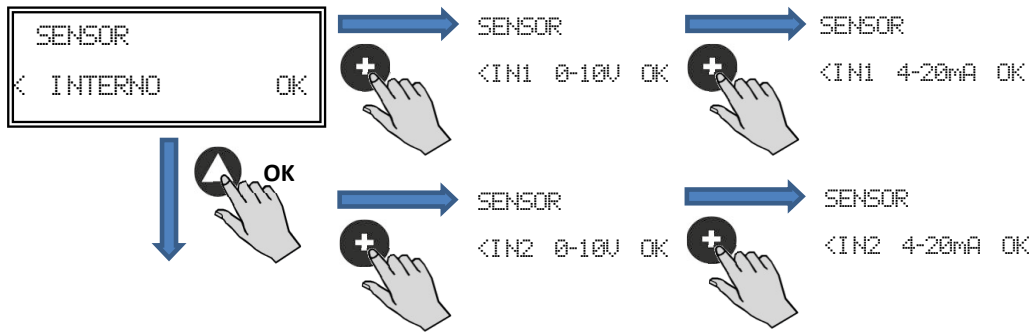

Sensor: Tipo de sensor

- **INTERNO:** Sonda diferencial de presión interna
- **IN1 0-10V:** Sonda externa señal analógica 0-10V (terminal J5)
- **IN1 4-20mA:** Sonda externa señal analógica 4-20mA (terminal J5)
- **IN2 0-10V:** Sonda externa señal analógica 0-10V (terminal J6)
- **IN2 4-20mA:** Sonda externa señal analógica 4-20mA (terminal J6)



Pulsar **+** o **-** para modificar manualmente el parámetro. El valor que aparece en pantalla corresponde a la escala del sensor interno preajustado en fábrica. Si se instala un sensor externo, introducir el rango de escala correspondiente.

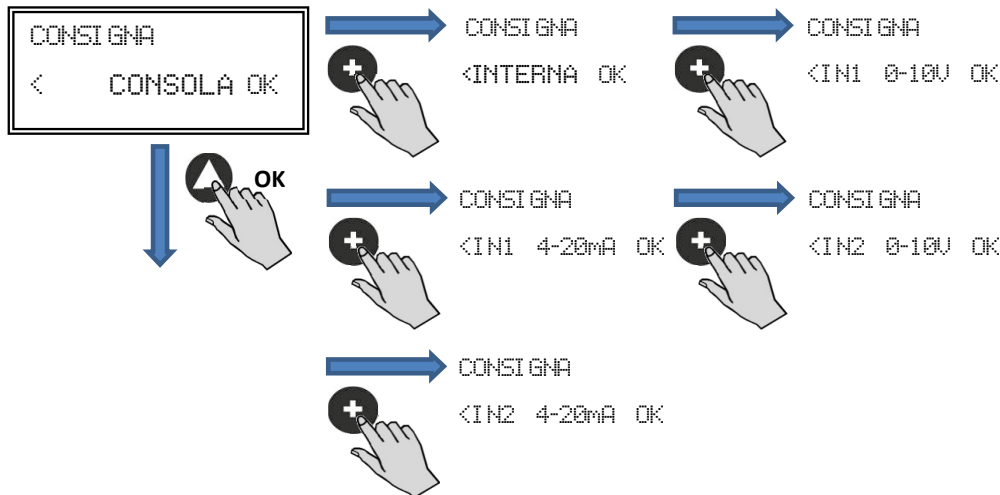

Consigna:

- **INTERNA**
- **CONSOLA:** Valor ajustado mediante consola PROSYS ECOWATT. Valor definido de fábrica
- **IN1/IN2 0-10V:** Valor ajustado mediante potenciómetro externo (0-10V)
- **IN1/IN2 4-20mA:** Valor ajustado mediante potenciómetro externo (4-20mA)



Pulsar **+** o **-** para modificar manualmente el valor de consigna. Éste apartado sólo aparece si en menú "CONSIGNA" se ha seleccionado "CONSOLA".

PARAMETROS
< Kp=133 OK



PARAMETROS
< Kp=100 OK



PARAMETROS
< Ki=20 OK



SENSOR IN1
<SIN SENSOR OK

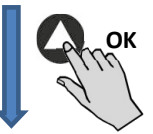

SP-2 CAUDAL
< 50% OK



ENTRADA DIGITAL
< (NC) OK



SALIDA PULSOS
< 4 OK



Pulsar **+** o **-** para modificar manualmente el parámetro. **Se aconseja no modificar.**

Pulsar **+** o **-** para modificar manualmente el parámetro. **Se aconseja no modificar.**

Pulsar **+** o **-** para modificar manualmente el parámetro. **Se aconseja no modificar.**

Pulsar **+** o **-** para modificar manualmente el parámetro. **Se aconseja no modificar.**

Pulsar **+** o **-** para modificar manualmente el parámetro. Este valor corresponde al % sobre la presión de consigna estando el ventilador en posición noche. Para ello se puede conectar un reloj o interruptor libre de potencial en la entrada digital J11



Entrada digital:

- **NC:** Contacto normalmente cerrado. El ventilador pasa a posición noche cuando el contacto se abre.
- **NO:** Contacto normalmente abierto. El ventilador pasa a posición noche cuando el contacto se cierra.

Pulsar **+** o **-** para modificar manualmente el parámetro que permite visualizar la velocidad del motor mediante la salida J8 (TACOM). **Se aconseja no modificar valor por defecto.**

PROGRAMAR C:1?
< NO SI

Guardar en memoria parámetros modificados

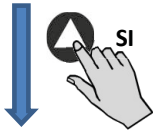

Programacion OK
<Pulsar tecla>

Apretar cualquier tecla para volver a la pantalla inicial



6.6.5. Funcionamiento modo PROPORCIONAL/VAV

En esta modalidad la caja de ventilación está preparada para trabajar con una o dos entradas analógicas (4-20mA o 0-10V). El control actúa en función del parámetro de máxima demanda. Las sondas se conectan en las entradas analógicas J5 y/o J6.

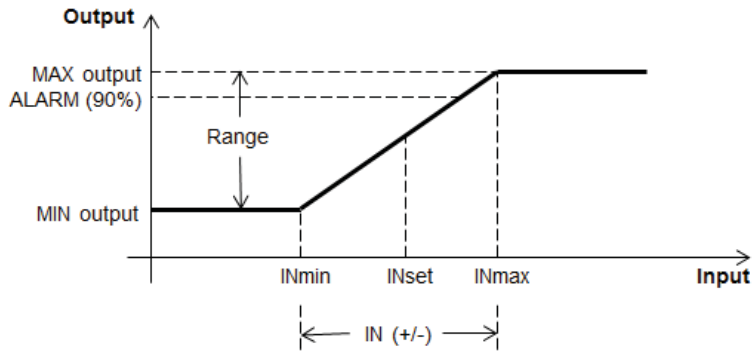

Funcionamiento Modo PROPORCIONAL/VAV

Una vez seleccionado el modo de funcionamiento PROPORCIONAL, aparecerán los parámetros siguientes:

SENSOR IN1
< SIN SENSOR OK



SENSOR IN1
< 0-10V%HR OK



SENSOR IN1
< 4-20mA%HR OK



SENSOR IN1
< 0-10VTempOK



SENSOR IN1
< 4-20mATempOK



SENSOR IN1
< 0-10VCO2 OK



SENSOR IN1
< 4-20mA CO2 OK

Sensor IN1:

- SIN SENSOR: Ningún sensor conectado a esta entrada
- 0-10V/4-20mA %HR: Sensor humedad salida analógica 0-10V/4-20mA
- 0-10V/4-20mA TEMP: Sensor temperatura salida analógica 0-10V/4-20mA
- 0-10V/4-20mA CO2: Sensor CO2 salida analógica 0-10V/4-20mA

INI RANGO
< 100%HR OK



INI SET
< 50%HR OK



INI (+/-)
< 25%HR OK



Pulsar **+** o **-** para modificar manualmente el fondo de escala del sensor utilizado

Pulsar **+** o **-** para modificar manualmente el valor medio del rango de utilización

Pulsar **+** o **-** para modificar manualmente el valor de anchura del rango de ajuste de la sonda

Seguir el mismo proceso si se ha seleccionado otro tipo de sensor o se ha activado la segunda entrada analógica SENSOR IN2.

SALIDA-MIN
< 20% OK

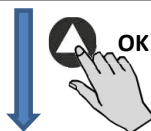

SALIDA-MAX
< 100% OK

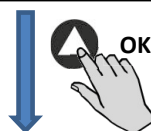

PARAM.NIVEL 2?
< NO SI



Pulsar **+** o **-** para modificar manualmente el parámetro

Pulsar **+** o **-** para modificar manualmente el parámetro

Acceso a configuración de parámetros avanzados

ENTRAR PASSWORD:
1 1 1 OK

Introducir la contraseña de acceso específica del canal.
Por defecto: 1 1 1

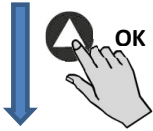

CAMBIAR PASSWORD
SI NO

Es posible asignar una nueva contraseña al equipo (canal)

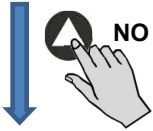

TIPO MOTOR
< EC OK

No modificar

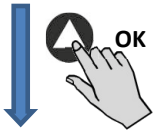

S1-ALARMA
< 90% OK

Pulsar **+** o **-** para modificar manualmente el parámetro. Este valor permite enviar un mensaje de alarma cuando el valor medido por la sonda IN1 alcanza un porcentaje del valor del rango de medida.

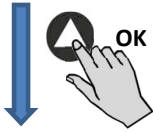

S2-ALARMA
< 90% OK

Pulsar **+** o **-** para modificar manualmente el parámetro. Este valor permite enviar un mensaje de alarma cuando el valor medido por la sonda IN2 alcanza un porcentaje del valor del rango de medida.

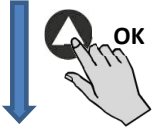

MIN RPM-ALARMA
< 500 OK

Pulsar **+** o **-** para modificar manualmente el parámetro. Permite enviar un mensaje de alarma cuando el valor de RPM del ventilador llega a un valor mínimo.

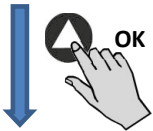

SALIDA PULSOS
< 4 OK

Pulsar **+** o **-** para modificar manualmente el parámetro. **Se aconseja no modificar valor por defecto.**

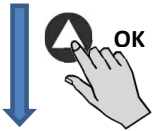



Validación parámetros modificados

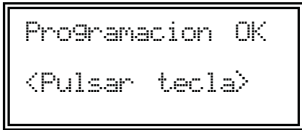
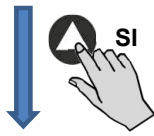

Validación volcado programación

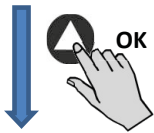

6.6.6. Funcionamiento modo MIN/MAX

En este modo, la caja de control está preparada para trabajar mediante contacto, tipo normalmente abierto (NO) o normalmente cerrado (NC), situados en la entrada digital J11. Cuando el estado de esta entrada cambia, el ventilador pasa a velocidad mínima con un valor de ajuste en % de la velocidad máxima.

Lógica:

- NO (contacto normalmente abierto): El ventilador pasa a "velocidad mínima" cuando el contacto se cierra.
- NC (contacto normalmente cerrado): El ventilador pasa a "velocidad mínima" cuando el contacto se abre.

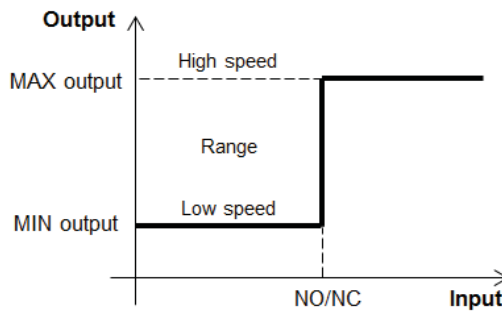

Funcionamiento Modo MIN/MAX

Una vez seleccionado el modo de funcionamiento MIN/MAX, aparecerán los parámetros:

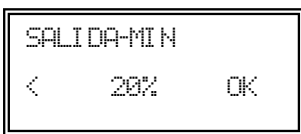

Pulsar **+** o **-** para modificar manualmente el valor de salida mínima

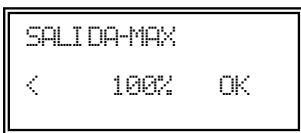
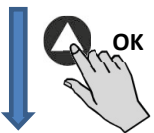

Pulsar **+** o **-** para modificar manualmente el valor de salida máxima



PARAM. NIVEL 2?
< NO SI

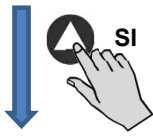

ENTRAR PASSWORD:
1 1 1 OK

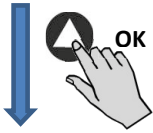

CAMBIAR PASSWORD
SI NO

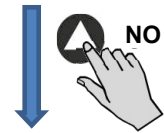

TIPO MOTOR
< EC OK

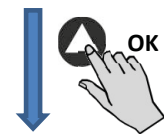

ENTRADA DIGITAL
< (NO) OK

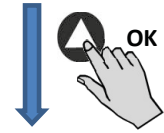

SALIDA PULSOS
< 4 OK

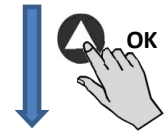

PROGRAMAR C: 1?
< NO SI

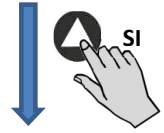

Programacion OK
<Pulsar tecla>

Acceso a configuración de parámetros avanzados

Introducir la contraseña de acceso específica del canal.
Por defecto: 1 1 1

Es posible asignar una nueva contraseña al equipo (canal)

No modificar



Entrada digital:

- **NO:** El ventilador pasa a velocidad mínima cuando el contacto se cierra.
- **NC:** El ventilador pasa a velocidad mínima cuando el contacto se abre.

Pulsar **+** o **-** para modificar manualmente el parámetro. **Se aconseja no modificar valor por defecto.**

Validación parámetros modificados

Validación volcado programación

7. FUNCIONAMIENTO CON ACCESORIO PROGRAMADOR HORARIO TIMER RTC ECOWATT JUNTO CON EL ACCESORIO CONSOLA PROSYS ECOWATT

Adquiriendo el programador horario **TIMER RTC ECOWATT** ofrecido como accesorio, se tendrá acceso a las funciones descritas en el apartado *6 Funciones Consola PROSYS ECOWATT*, además de poder programar lo siguiente:

- **Hasta tres periodos diarios a la consigna deseada**
- **Periodo vacaciones** mediante la programación de fecha y hora de inicio /final y % sobre la velocidad máxima deseado

7.1. INSTALACIÓN

Tal y como se muestra en la imagen inferior, el programador horario es un componente electrónico que se deberá instalar en el interior de la caja de control.

Para realizarlo correctamente, seguir los pasos siguientes:

1. Desconectar la tensión mediante el interruptor frontal
2. Acceder al interior de la caja de control
3. Localizar el conector J4

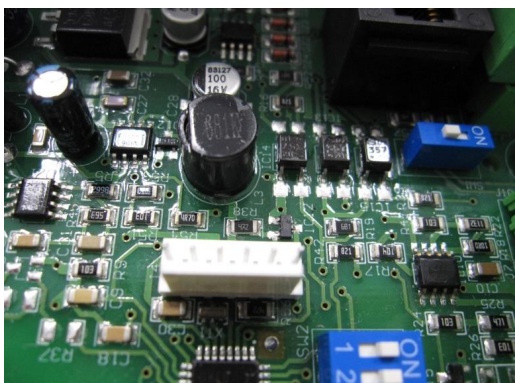

4. Alinear el componente electrónico TIMER RTC ECOWATT con las patillas del conector J4

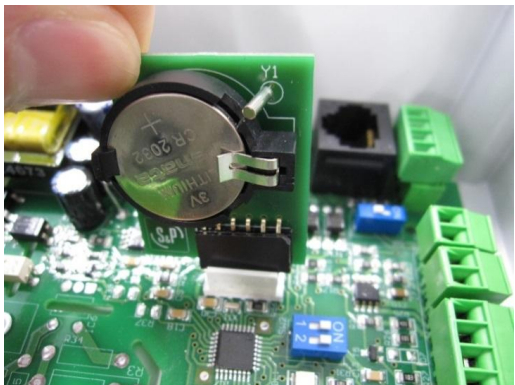

5. Encajar el componente electrónico presionando hacia abajo



TIMER RTC ECOWATT

NOTA: Una vez instalado, pulsar dos veces la tecla  de la consola PROSYS ECOWATT para visualización de fecha y hora.

7.2. PROGRAMACIÓN

IMPORTANTE: Antes de empezar a configurar el programador horario es importante seleccionar el modo apropiado. Ver punto 6.6.1. Cambio modo funcionamiento de este manual y escoger uno de los siguientes modos: *PI PRESION+RTC*, *PI CAUDAL+RTC*, *PROPORCIONAL+RTC* o *MAX-MIN+RTC*.

Durante el proceso de programación se deberán definir los siguientes parámetros:

- **T1, T2, T3:** Hora de inicio para cada temporización (OFF,00:00-23:59)
- **Tiempo T1, Tiempo T2, Tiempo T3:** La duración en minutos de cada temporización relacionada con su hora de inicio (hasta 480 minutos)
- **Consigna T1, Consigna T2, Consigna T3:** La consigna en porcentaje deseada durante la temporización sobre el modo de funcionamiento previamente seleccionado *[ejemplo: si se selecciona un modo PI PRES+RTC y se define una consigna T1 de 50%, durante la temporización el ventilador reducirá el valor de presión de referencia, SC, en un 50%]*.

La tabla siguiente servirá de ejemplo:

	LUNES	MARTES	...	SÁBADO	DOMINGO
1:00	T3 = 480 min ConsignaT3 = 25%	T3 = 480 min ConsignaT3 = 25%	...	T3 = 480 min ConsignaT3 = 25%	T3 = 480 min ConsignaT3 = 25%
2:00					
3:00					
4:00					
5:00					
6:00					
7:00					
8:00				T1 = 60min ConsignaT1 = 50%	T1 = 60min ConsignaT1 = 50%
9:00				T2 = 120 min ConsignaT1 = 50%	T2 = 120 min ConsignaT1 = 50%
10:00	T1 = 60min ConsignaT1 = 50%	T1 = 60min ConsignaT1 = 50%			
11:00					
12:00					
13:00					
14:00	T2 = 120 min ConsignaT1 = 50%	T2 = 120 min ConsignaT1 = 50%			
15:00					
16:00					
22:00					
23:00	T3 = 480 min ConsignaT3 = 25%	T3 = 480 min ConsignaT3 = 25%		T3 = 480 min ConsignaT3 = 25%	T3 = 480 min ConsignaT3 = 25%
0:00					

Para iniciar a programar, realizar la secuencia siguiente:

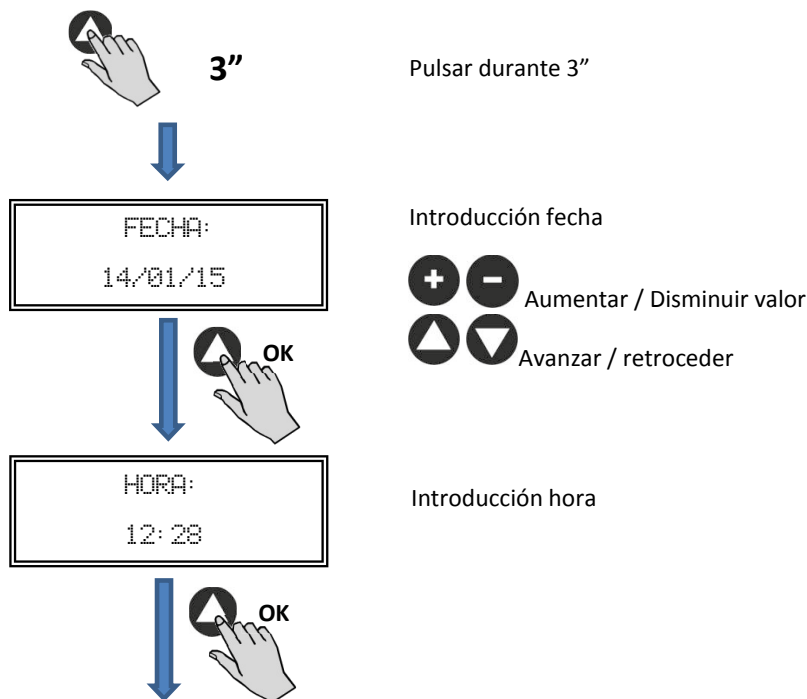

SALIR?
CONT SI



LUNES
T1 09:00

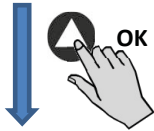

LUNES
T2 11:00

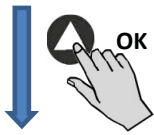

LUNES
T3 14:00



MARTES
NO IGUAL? SI

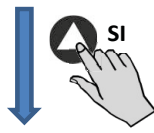

TIEMPO T1
5 m

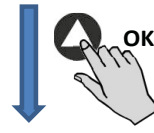

TIEMPO T2
15 m

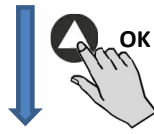

Presionando sobre **SI** se vuelve a pantalla inicial

Introducción hora inicio temporización T1 para el lunes

Introducción hora inicio temporización T2 para el lunes

Introducción hora inicio temporización T3 para el lunes

Aceptando se copia la programación del lunes

Introducción duración temporización T1 (0 – 480 min)

Introducción duración temporización T2 (0 – 480 min)

CONSIGNA T1
80

Introducción porcentaje sobre la consigna del modo de funcionamiento seleccionado (OFF,0-100%)

Seguir secuencia

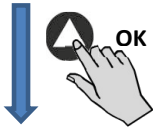

FECHA INICIO
19/12/14

Introducción fecha inicio periodo vacaciones

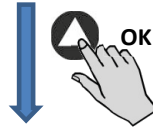

HORA INICIO
14:58

Introducción hora inicio periodo vacaciones

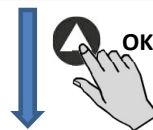

FECHA FIN
30/12/14

Introducción fecha fin periodo vacaciones



HORA FIN
20:00

Introducción hora fin periodo vacaciones

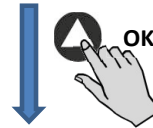

CONSIGNA VAC
20%

Introducción porcentaje sobre consigna periodo vacaciones



SALIR?
NO SI

Confirmar configuración

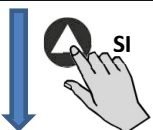

Programacion OK
<Pulsar tecla>

Validación volcado programación



7.3. TABLA RESUMEN VALORES DE AJUSTE

Registro	Min.	Max.	Comentarios
T1 T2 T3	OFF	23:59	Hora inicio temporización
Tiempo T1 Tiempo T2 Tiempo T3	0min	480min	Duración minutos temporización
Consigna T1 Consigna T2 Consigna T3	OFF	100%	Porcentaje sobre la consigna
Fecha Inicio	00:00	23:59	Fecha inicio periodo vacaciones
Hora Inicio	00:00	23:59	Hora inicio periodo vacaciones
Fecha Fin	00:00	23:59	Fecha fin periodo vacaciones
Hora Fin	00:00	23:59	Hora fin periodo vacaciones
Consigna VAC	OFF	100%	Consigna periodo vacaciones

8. INTEGRACIÓN A SISTEMA DE COMUNICACIÓN MODBUS

8.1. CARACTERÍSTICAS BÁSICAS DEL CONTROL MODBUS-RTU

Direccionamiento	Esclavo: dirección configurable desde 1 a 247	Maestro: debe poder direccionarse a los esclavos con dirección desde el 1 a 247
Difusión	Si	
Velocidad de transmisión	9600 (19200 es recomendado también)	
Paridad	PAR/EVEN	
Modo	RTU	
Interfaz eléctrica	RS485 2W-cableado o RS232	
Tipo conector	RJ 45	

Mensaje MODBUS

Dirección	Función	Datos	Verificación CRC
8 bits	8 bits	N x 8bits	16 bits

El formato para cada byte en modo RTU es:

- Sistema de códigos: 8-bit binario
- Bits por Byte: 1 bit de START (inicio)
8 bits de datos, el bit más significativo se envía el primero
1 bit para la paridad (Se requiere paridad par)
1 bit de STOP (fin)

Holding registers

NºREG.	Registro	Min.	Max.	Descripción	Por defecto	Comentarios
0	TipoMotor	0	1	0=AC 1=DC	1	Tipo Motor
1	ModoFun	0	7	0=PI_Presión 1=PI_Caudal 2=Proporcional 3=Max-Min 4=PI_Presión+RTC 5=PI_Caudal+RTC 6=Proporcional+RTC 7=Max-Min+RTC	0	Modo de funcionamiento
2	SensorPI	0	4	0=Interno 1=IN1 0-10V 2=IN1 4-20mA 3=IN2 0-10V 4=IN2 4-20mA	0	Tipos de sensores para modo PI_Presión o PI-Caudal
3	Sensor1	0	7	0=NO 1=0-10V %HR 2=4-20mA %HR 3=0-10V °C 4=4-20mA °C 5=0-10V CO2 6=4-20mA CO2 7=NTC 100K	0	Tipo de sensor modo Proporcional para entrada analógica 1
4	Sensor2	0	6	0=NO 1=0-10V %HR 2=4-20mA %HR 3=0-10V °C 4=4-20mA °C 5=0-10V CO2 6=4-20mA CO2	0	Tipo de sensor modo Proporcional para entrada analógica 2
5	PIRange	50 50 100	1250 2500 9900	SensorPI=0 SensorPI<>0 Sensor<>0	400 (CAB-125/150/160 ECOWATT) 500 (CAB-200/315 ECOWATT) 650 (CAB-250 ECOWATT) 550 (CAB-355/400 ECOWATT)	Fondo escala modo PI
6	SetPoint	0	5	0=Interno 1=IN1 0-10V 2=IN1 4-20mA 3=IN2 0-10V 4=IN2 4-20mA 5=ConsolaMODBUS (PROSYS ECOWATT)	5	Consigna modo PI
7	Kp	1	250	Incrementos 1	20	Constante Proporcional modoPI
8	Ki	1	250	Incrementos 1	20	Constante Integral modoPI
9	Kq	50	300	Incrementos 1	50 (CAB-125 ECOWATT) 56 (CAB-150/160 ECOWATT) 81 (CAB-200 ECOWATT) 88 (CAB-250 ECOWATT) 108 (CAB-315 ECOWATT) 136 (CAB-355 ECOWATT) 81 (CAB-400 ECOWATT)	Constante Caudal con sensor de presión
10	PulsosEncoder	0	16	Incrementos 1	2 5 1	Números pulsos por vuelta del encoder
11	MinOut	0	50	Incrementos 5%	25	Valor salida mínima

NºREG.	Registro	Min.	Max.	Descripción	Por defecto	Comentarios
12	MaxOut	50	100	Incrementos 5%	100	Valor salida máxima
13	S1Alarm	0	100	Incrementos 5%	90	Alarma entrada analógica 1
14	S2Alarm	0	100	Incrementos 5%	90	Alarma entrada analógica 1
15	MinRPM	100	500	Incrementos de 100	300	Min RPM alarma
16	VacMIN	80	150	Incrementos de 10	80	Voltaje mínimo Motor AC
17	IN1 Range	0 0 0	100 50 2000	%HR incrementos °C incrementos PPM incrementos	100	Fondo escala modo Proporcional entrada 1
18	IN2 Range	0 0 0	100 50 2000	%HR incrementos °C incrementos PPM incrementos	2000	Fondo escala modo Proporcional entrada 2
19	IN1 Set	0	IN1 Range	Incrementos de 1	70	Consigna modo Proporcional entrada 1
20	IN1 Banda	0	IN1 Range	Incrementos de 1	40	Margen (+/-) centrado en IN1 Set
21	IN2 Set	0	IN2 Range	Incrementos de 1	1000	Consigna modo Proporcional entrada 2
22	IN2 Banda	0	IN2 Range	Incrementos de 1	1000	Margen (+/-) centrado en IN2 Set
23	InD	0	1	0=NO 1=NC	0	Inversión Entrada Digital
24	setMODBUS	1	PIRange	Incrementos de 50	100 (CAB-125 ECOWATT) 150 (CAB-150/160/200/150/315 ECOWATT) 200 (CAB-355/400 ECOWATT)	Consigna MODBUS
25	IDIOMA	0	3	0=INGLES 1=ESPAÑOL 2=FRANCES 3=ALEMÁN	0	Idioma
26	SP-2 PRESION	25	100	Incrementos de 1	25	Consigna noche modo PI Presión
27	SP-2 CAUDAL	50	100	Incrementos de 1	50	Consigna noche modo PI Caudal
28	SP Temp	-10	50	Incrementos de 1		Consigna Temperatura (sólo para modelo CTBH ECOWATT)
29	adMODBUS	1 0	247 100	Incrementos de 1	1	
30	ALARMA	0	1			
31	FECHA	0x0000	0xfe7f	Día/Mes/Año	0x088E	Fecha actual
32	HORA	0x0000	0x3dfb	Hora/Minuto	0x0000	Hora actual
33	LUNES T1	0x0000	0x063b	Hora/Minuto	0x0200	Inicio temporización 1 lunes
34	LUNES T2	0x0000	0x063b	Hora/Minuto	0x0300	Inicio temporización 2 lunes
35	LUNES T3	0x0000	0x063b	Hora/Minuto	0x0480	Inicio temporización 3 lunes
36	MARTES T1	0x0000	0x063b	Hora/Minuto	0x0200	Inicio temporización 1 martes
37	MARTES T2	0x0000	0x063b	Hora/Minuto	0x0300	Inicio temporización 2 martes
38	MARTES T3	0x0000	0x063b	Hora/Minuto	0x0480	Inicio temporización 3 martes
39	MIERCOLES T1	0x0000	0x063b	Hora/Minuto	0x0200	Inicio temporización 1 miércoles
40	MIERCOLES T2	0x0000	0x063b	Hora/Minuto	0x0300	Inicio temporización 2 miércoles
41	MIERCOLES T3	0x0000	0x063b	Hora/Minuto	0x0480	Inicio temporización 3 miércoles
42	JUEVES T1	0x0000	0x063b	Hora/Minuto	0x0200	Inicio temporización 1 jueves
43	JUEVES T2	0x0000	0x063b	Hora/Minuto	0x0300	Inicio temporización 2 jueves
44	JUEVES T3	0x0000	0x063b	Hora/Minuto	0x0480	Inicio temporización 3 jueves
45	VIERNES T1	0x0000	0x063b	Hora/Minuto	0x0200	Inicio temporización 1 viernes
46	VIERNES T2	0x0000	0x063b	Hora/Minuto	0x0300	Inicio temporización 2 viernes

N°REG.	Registro	Min.	Max.	Descripción	Por defecto	Comentarios
47	VIERNES T3	0x0000	0x063b	Hora/Minuto	0x0480	Inicio temporización 3 viernes
48	SABADO T1	0x0000	0x063b	Hora/Minuto	0x0200	Inicio temporización 1 sábado
49	SABADO T2	0x0000	0x063b	Hora/Minuto	0x0300	Inicio temporización 2 sábado
50	SABADO T3	0x0000	0x063b	Hora/Minuto	0x0480	Inicio temporización 3 sábado
51	DOMINGO T1	0x0000	0x063b	Hora/Minuto	0x0200	Inicio temporización 1 domingo
52	DOMINGO T2	0x0000	0x063b	Hora/Minuto	0x0300	Inicio temporización 2 domingo
53	DOMINGO T3	0x0000	0x063b	Hora/Minuto	0x0480	Inicio temporización 3 domingo
54	TIEMPO T1	0	480	1	60	Duración minutos temporización 1
55	TIEMPO T2	0	480	1	60	Duración minutos temporización 2
56	TIEMPO T3	0	480	1	60	Duración minutos temporización 3
57	CONSIGNA T1	0	100	1	80	Porcentaje sobre la consigna
58	CONSIGNA T2	0	100	1	60	Porcentaje sobre la consigna
59	CONSIGNA T3	0	100	1	100	Porcentaje sobre la consigna
60	FECHA INICIO	0	0xfe7f	Día/Mes/Año	0x088E	Fecha inicio periodo vacaciones
61	HORA INICIO	0x0000	0x063b	Hora/Minuto	0	Hora inicio periodo vacaciones
62	FECHA FIN	0	0xfe7f	Día/Mes/Año	0x088E	Fecha fin periodo vacaciones
63	HORA FIN	0x0000	0x063b	Hora/Minuto	0	Hora fin periodo vacaciones
64	CONSIGNA VAC	0	100	1	20	Consigna periodo vacaciones
65	VERSION	0	250	1		Solo consulta
66	BAUDRATE	0	3	0=19200 1=9600 2=4800 3=2400	1	Velocidad transmisión
67	PARIDAD	0	2	0=No 1=Even 2=Odd	1	Paridad de la trama MODBUS

Input registers (sólo lectura)

N°REG.	Registro	Min.	Max.	Descripción	Por defecto	Comentarios
0	Pote	0	255	Potenciómetro RV1 PCB		Potenciómetro RV1
1	In1	0	255	Entrada Analógica 1		Entrada Analógica 2
2	In2	0	255	Entrada Analógica 2		Entrada Analógica 2
3	Interno	0	1250	Sensor presión int.		Sensor presión interno
4	Rpm	0	6000	Rpm motor		Velocidad del motor (si rpm<100, rpm=0)

Discrete inputs (sólo lectura)

N°REG.	Registro	Min.	Max.	Descripción	Por defecto	Comentarios
0	InD	0	1	Entrada Digital		Entrada Digital

Output coils (sólo lectura)

N°REG.	Registro	Min.	Max.	Descripción	Por defecto	Comentarios
0	Output	0	1	Relé		Relé

9. MANTENIMIENTO

Antes de manipular el ventilador, asegúrese de que está desconectado de la red, aunque ya esté parado y de que nadie pueda ponerlo en marcha durante la intervención.

Es necesaria una inspección regular del aparato. La frecuencia de la misma, debe ser en función de las condiciones de trabajo para evitar la acumulación de suciedad en hélices, rodetes, motores y rejillas que podría entrañar riesgos y acortaría sensiblemente la vida del mismo.

En las operaciones de limpieza tener mucha precaución de no desequilibrar la hélice o rodete.

En todos los trabajos de mantenimiento y reparación, deben observarse las normas de seguridad vigente en cada país.

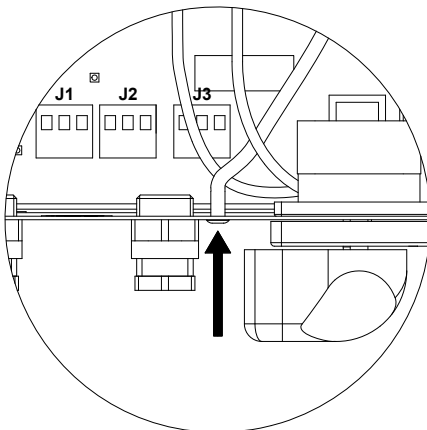

Verificar la limpieza del orificio de toma de presión ambiental. La acumulación de suciedad falseará la lectura y provocará un comportamiento anómalo.

10. PUESTA FUERA DE SERVICIO Y RECICLAJE



La normativa CEE y el compromiso que debemos adquirir en futuras generaciones nos obligan al reciclado de materiales; le rogamos que no olvide depositar todos los elementos sobrantes del embalaje en los correspondientes contenedores de reciclaje. Si su aparato, además, está etiquetado con este símbolo, no olvide llevar el aparato sustituido al Gestor de Residuos más próximo.

CONTENTS

1. INTRODUCTION.....	36
2. SAFETY REGULATIONS AND “CE” MARKING.....	36
3. GENERAL INSTRUCTIONS.....	36
4. DESCRIPTION	37
4.1. Locations.....	37
4.2. Wiring diagram and internal board	38
5. OPERATION WITHOUT PROSYS ECOWATT CONSOLE.....	39
6. OPERATION WITH PROSYS ECOWATT ACCESSORY CONSOLE	39
6.1. Description.....	40
6.2. Using the console.....	40
6.3. Installation	41
6.4. General parameters.....	44
6.5. Starting the system.....	44
6.6. Unit configuration via console	45
6.6.1. Change Set Point.....	45
6.6.2. Change operation mode	45
6.6.3. Operation PI PRESSURE/COP mode.....	46
6.6.4. Operation CAV/PI VOLUME mode.....	49
6.6.5. Operation PROPORTIONAL/VAV mode.....	53
6.6.6. MIN/MAX operation mode	56
7. OPERATION WITH TIMER RTC ECOWATT ACCESSORY AND PROSYS ECOWATT CONSOLE ACCESSORY.....	58
7.1. Installation	58
7.2. Programming.....	59
7.3. Summary table setting values.....	62
8. MODBUS COMMUNICATION SYSTEM INTEGRATION.....	62
8.1. Basic features of Modbus-RTU control	62
8.2. Modbus memory map	63
9. MAINTENANCE	66
10. RECYCLING	66

1. INTRODUCTION

Thank you for purchasing this appliance. It has been manufactured in full compliance with applicable safety regulations and **EU** standards. Please read this instruction book carefully, as it contains important information for your safety during the installation, use and maintenance of this product.

Keep it at hand for future reference.

Please check that the appliance is in perfect condition when you unpack it, as all factory defects are covered by the **S&P** guarantee.

2. SAFETY REGULATIONS AND "CE" MARKING

S&P technicians are firmly committed to research and development of ever more efficient products and in compliance with current safety regulations.

The instructions and recommendations given below reflect current regulations, principally regarding safety, and therefore are based on compliance with general regulations. Therefore, we recommend all people exposed to hazards to strictly follow the safety regulations in force in your country. **S&P** will not be held liable for any possible harm or damage caused by non-compliance with the safety regulations, as well as caused by modifying the product.

The CE mark and the corresponding declaration of conformity are proof of the product's conformity with current **EU** regulations.

3. GENERAL INSTRUCTIONS

A hazard analysis of the product has been carried out as provided in the Machine Directive. The manual contains information for all personnel exposed to these hazards, with aim of preventing possible harm or damage due to faulty handling or maintenance.

All maintenance operations (ordinary and extraordinary) must be carried out with the machine switched off and the electrical power supply disconnected.

Before connecting the power supply cable to the terminal strip, make sure the mains voltage corresponds to the voltage indicated on the specifications plate of the unit.

Power supply cable must pass twice, through one loop, for the ferrite WE74271221 included in the packaging.



4. DESCRIPTION

4.1. LOCATIONS

EN

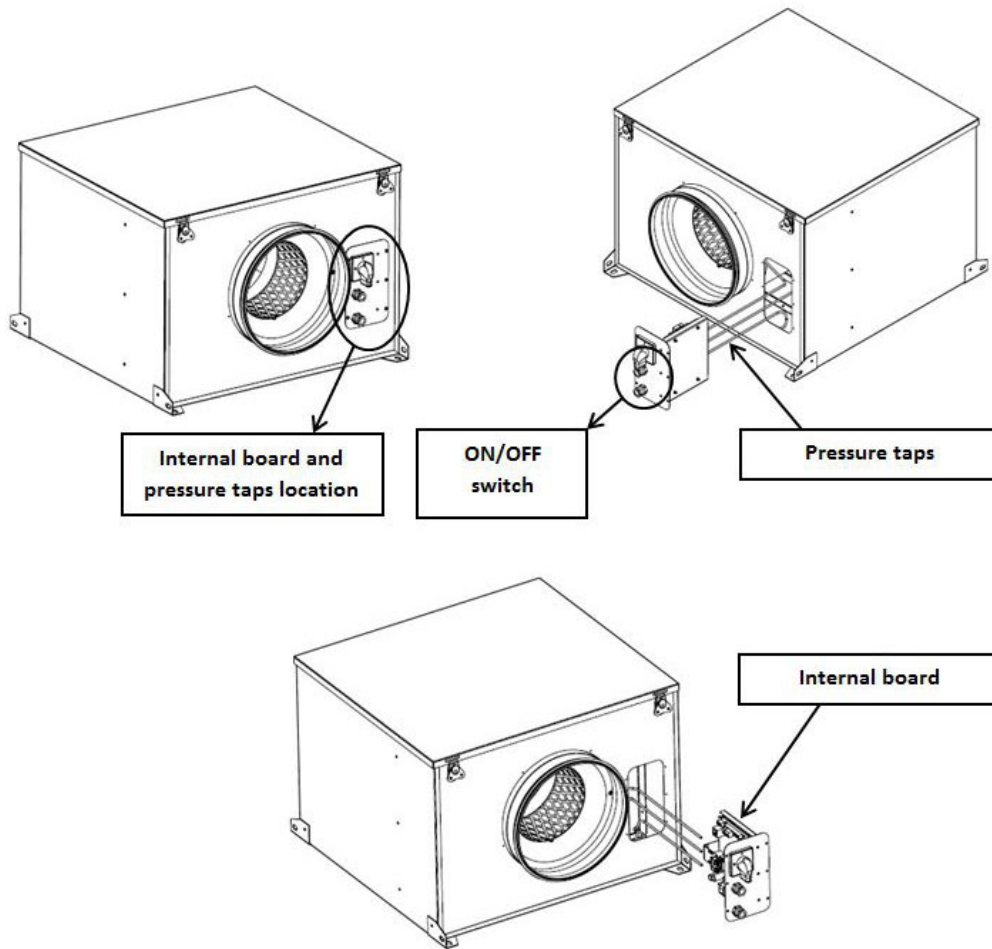

IMPORTANT

Inside of location for internal board, three tubes (marked as "V", "P-" and "P+") come from the inside part of the fan. As the fan is supplied as constant pressure mode (COP), tube "P-" is connected. To keep this configuration unless chapter 6.6.3. is previously ridden.

4.2. WIRING DIAGRAM AND INTERNAL BOARD

EN

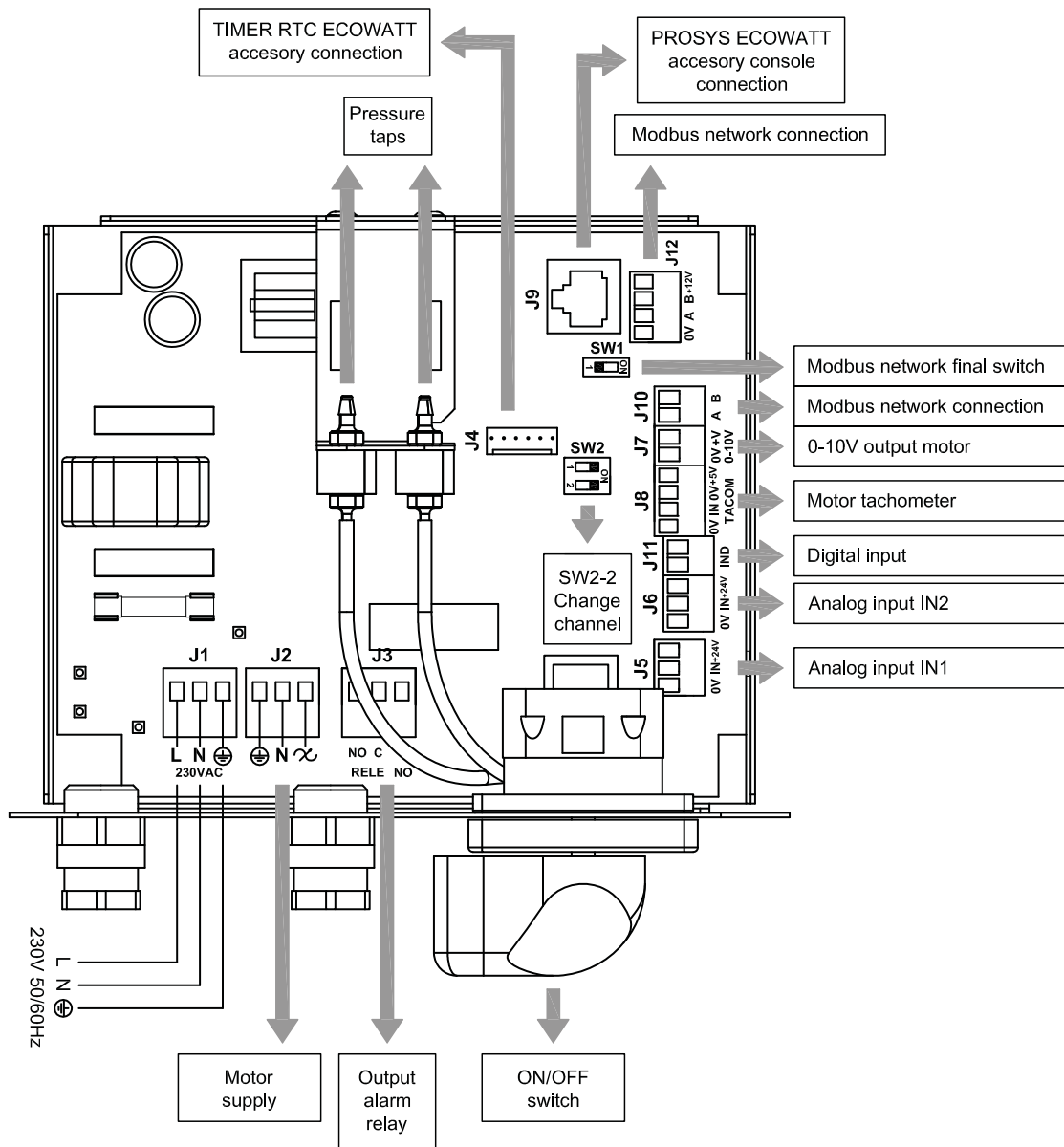

Inputs	Description
L, N, GND (J1)	Power supply. 220-230 V AC 50 Hz
Pressure tap 1	Tap to connect duct pressure depending on operation mode
Pressure tap 2	
Connector (J4)	Input to connect with programming schedule TIMER RTC ECOWATT accessory
0V, IN, +24V (J5)	Analog input IN1 4-20 mA ó 0-10V
0V, IN, +24V (J6)	Analog input IN2 4-20 mA ó 0-10V
RJ45 (J9)	PROSYS ECOWATT accessory console connection
IND (J11)	Digital input for night operation of MIN/MAX function mode If open, the fan works in night speed or minimum speed when relay is closed If close, the fan works in night speed or minimum speed when relay is opened

Outputs	Description
GND, N, \times (J2)	Internal board power supply passing through ON/OFF switch (Factory wired)
RELÉ (J3)	Commutate if any alarm is activated (2A maximum load)
0V, +V (J7)	Output analog signal 0-10V to the motor
TACOM (J8)	Pulse motor
A, B (J10)	Network connection. Modbus protocol
RS485 (J12)	Network connection. Modbus protocol

Micro switches	Description
SW1	End of line resistor. Exclusive use for Modbus communication network
SW2	SW2-2: enable channel change

5. OPERATION WITHOUT PROSYS ECOWATT CONSOLE

Acoustic cabinet fan CAB ECOWATT PLUS is ready to work on constant pressure mode (COP/PI PRESSURE) with a differential pressure reading taken on inlet side and a predefined set point from factory.

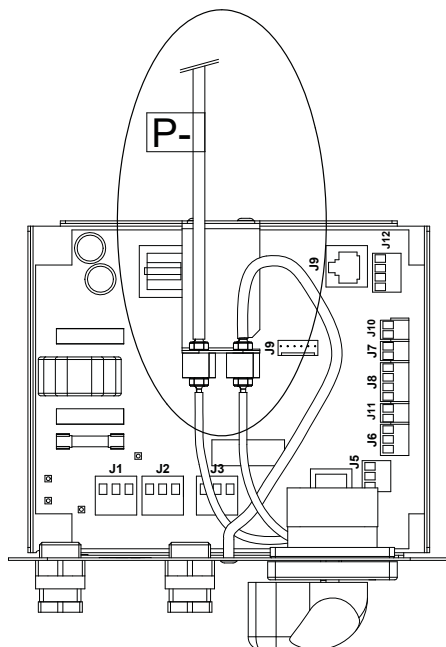

Constant pressure (inlet) by default

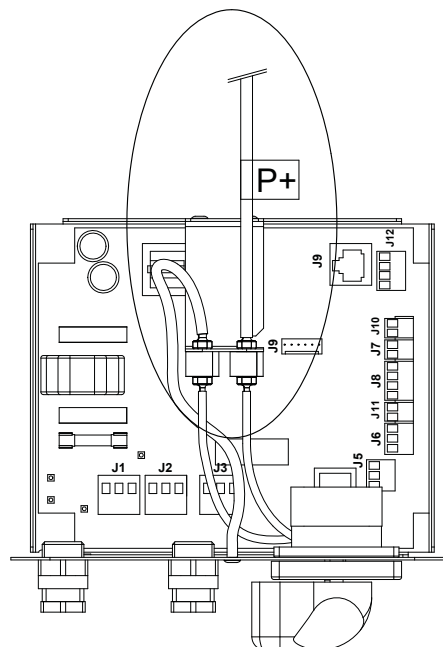

Constant pressure (outlet)

Pressure set point table

Model	Set point (Pa)
125	100
150	150
160	150
200	150
250	150
315	150
355	200
400	200

Factory setting is for constant pressure taken on inlet side. However, it is possible to do it from outlet side.

6. OPERATION WITH PROSYS ECOWATT ACCESSORY CONSOLE

Acquiring the PROSYS ECOWATT console offered as an optional accessory, you will have access to the following operation modes:

- **Constant pressure system (PI PRESSURE/COP)** with modifiable set point parameters.
- **Constant airflow system (PI VOLUME/CAV)** with modifiable set point parameters.
- **Variable airflow system (PROPORTIONAL/VAV)** (it is necessary to install an external sensor with an output analog signal 0-10V or 4-20mA).
- **MIN/MAX operating system** (it is necessary to install an external sensor with an output digital signal, time clock or external relay).



PROSYS ECOWATT

6.1. DESCRIPTION

The PROSYS ECOWATT is used as a visualization and control supplement. Following functions are possible:

- Display parameters and variables
- Save settings
- Display settings
- Configure your device and operating modes
- Search units (channels) in the network (previously each unit should be configured with different number of channels)

The console has a LCD display of 2x16 characters, 4 buttons and 3 LED's.

- Button "Up"
- Button "Down"
- Button "+"
- Button "-"
- LED power supply ON
- LED "activity" Modbus
- LED error

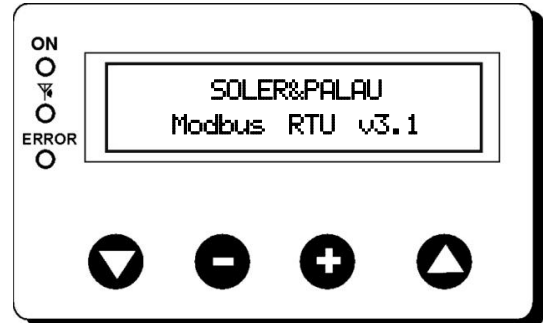

6.2. USING THE CONSOLE

When modifying the configured parameter, the buttons on the console have the following functions:

Button	Function
	Increase parameter value
	Decrease the parameter value
	Enter
	Exit

When navigating through the menus, the button function is different and depends on the existing indications on the display. Each button performs the function indicated just above it.

Examples:

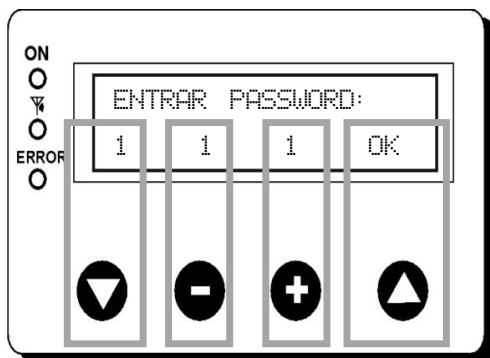

Button	Function
	Modify the value of 1st digit
	Modify the value of 2nd digit
	Modify the value of 3rd digit
	OK. Validate

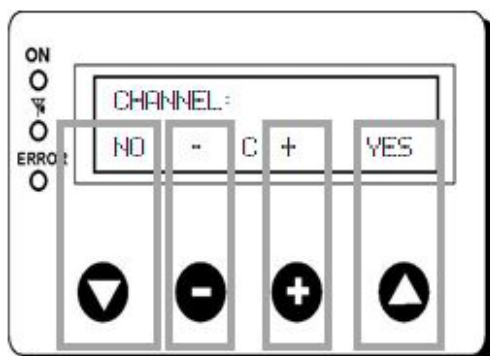

Button	Function
	NO = Exit
	Reduce channel value
	Increase channel value
	YES = Validate

6.3. INSTALLATION

It is possible to install a single PROSYS ECOWATT console linked with one CAB ECOWATT PLUS, or make a Modbus communication network linking more than one unit with one PROSYS ECOWATT console.

Individual control wiring diagram

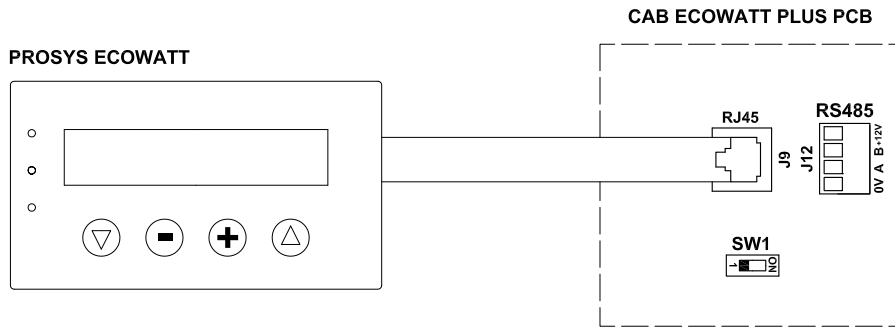

Multiple control wiring diagram

It is possible to connect up to 32 fans between them to create a communication network that can be adjusted and controlled with a single PROSYS ECOWATT console.

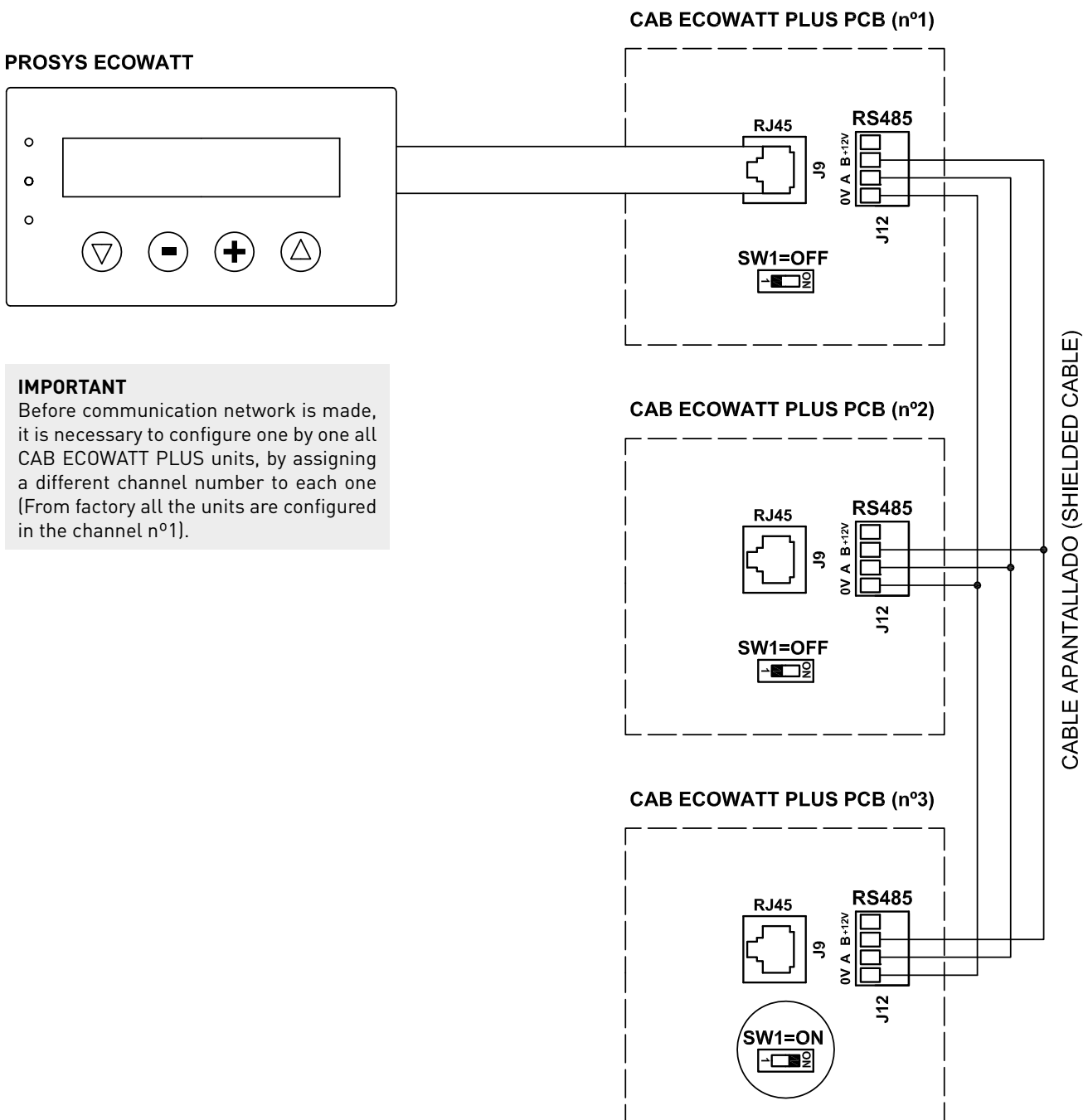

IMPORTANT
 Before communication network is made, it is necessary to configure one by one all CAB ECOWATT PLUS units, by assigning a different channel number to each one (From factory all the units are configured in the channel n°1).

To change the fan-channel number should follow these steps:

- Check that ON/OFF switch is in "0" position
- Access to the internal board and position the micro switch SW2-2 in "ON"
- Connect the PROSYS ECOWATT console to the internal board using J9 connector
- Turn on the device using the ON/OFF switch
- Select the desired language on the first screen
- Proceed as follows:

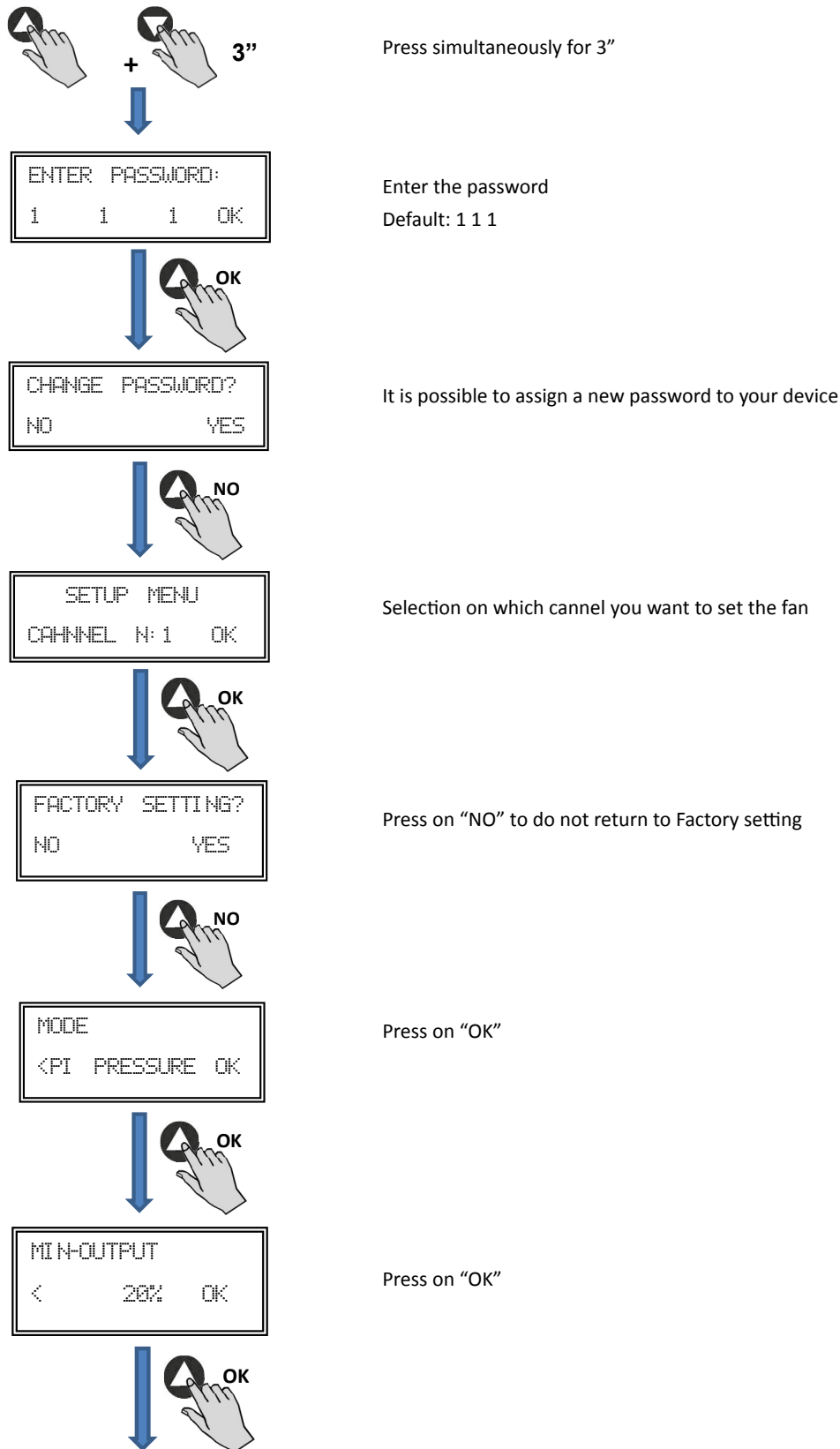

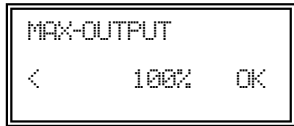

Press on "OK"

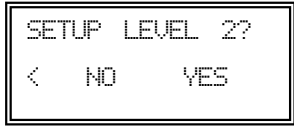

Press on "NO"

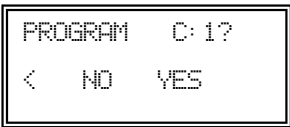
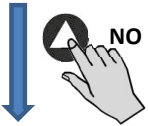

Press on "YES" to save changes

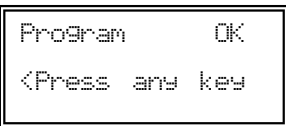

Press any key to return to main screen



- Turn off the device by ON/OFF switch in position "0".
- Access to the internal board again and position the micro switch SW2-2 in "OFF".
- The fan number change will be done when you restart the device.

Being PROSYS ECOWATT console connected to master unit, access to each unit by the number previously assigned through channel change screen. This will appear pressing  button repeatedly from main screen.

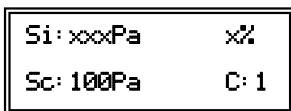

Main screen

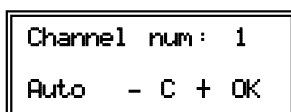

Channel change screen

6.4. GENERAL PARAMETERS

Once the wiring is done, turn on the device using the ON/OFF switch. When connecting the unit it will appear some screens:



After choosing the language, a screen with the following information will appear:

Si: xxxPa	x%
Sp: 100Pa	C: 1

- Si: xxx** Measured value (units depend on operation mode)
- Sp/Sc: xxx** Set point programmed
- X%** Fan speed in % (on high speed)
- C: 1** Fan number if connected to network

Pressing the button  can access the second screen of information:

RPM: xxx	InD: 0
Rele: 0	C: 1

- RPM: xxx** Fan speed (TACOM terminals connected is required)
- Rele: 0** It Indicates if the alarm output relay is connected (0: offline output; 1: output connected)
- InD: 0** Digital input (J11 night mode or Min/Max)(0: offline output; 1: output connected)
- C: 1** Communication channel used (de 1 a 247)

6.5. STARTING THE SYSTEM

Once done the wiring and configuration of existing units, proceed to the system power supply.

When connecting the unit, it will appear the initial screen with Software version, after 3 seconds will initiate the connection with number of memorized unit. If communication is successfully, it will appear the first information screen. Corresponding screen of PI PRESSURE mode will appear by default:

PI PRESSURE/ COP mode	PI VOLUME/ CAV mode								
<table border="1"> <tr> <td>Si: 100 Pa</td> <td>100%</td> </tr> <tr> <td>Sp: 100 Pa</td> <td>C: 1</td> </tr> </table>	Si: 100 Pa	100%	Sp: 100 Pa	C: 1	<table border="1"> <tr> <td>Si: 100 m³/h</td> <td>100%</td> </tr> <tr> <td>Sp: 100 m³/h</td> <td>C: 1</td> </tr> </table>	Si: 100 m ³ /h	100%	Sp: 100 m ³ /h	C: 1
Si: 100 Pa	100%								
Sp: 100 Pa	C: 1								
Si: 100 m ³ /h	100%								
Sp: 100 m ³ /h	C: 1								
PROPORTIONAL/ VAV mode	MIN-MAX mode								
<table border="1"> <tr> <td>S2: 30%HR</td> <td>21%</td> </tr> <tr> <td>C: 1</td> <td></td> </tr> </table>	S2: 30%HR	21%	C: 1		<table border="1"> <tr> <td>INLD: ON</td> <td>21%</td> </tr> <tr> <td>C: 1</td> <td></td> </tr> </table>	INLD: ON	21%	C: 1	
S2: 30%HR	21%								
C: 1									
INLD: ON	21%								
C: 1									

6.6. UNIT CONFIGURATION VIA CONSOLE

6.6.1. Change Set Point

Steps to follow to change the set point from main screen:

Si: XXX	x%
Sc: XXX	C:1

- Si: xxx** Measured value (units depend on operation mode)
- Sc: xxx** Set point
- X%** Fan speed in % (on maximum speed)
- C: 1** Equipment number if connected to network



3"

Press for 3"



SetP CONSOLE:		
XXX	XXX	OK

Press **+** or **-** to manually modify the set point

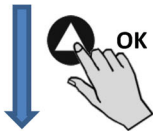

6.6.2. Change operation mode

Once the unit is powered, desired language selected and showing screen described above, continue with following sequence:



3"

Press simultaneously for 3"



ENTER PASSWORD:			
1	1	1	OK

Enter the password

Default: 1 1 1

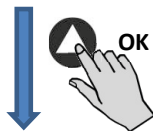

CHANGE PASSWORD	
SI	NO

It is possible to assign a new password to your device (channel)

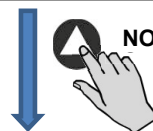

MENU CONFIG	
CHANNEL N:	1 OK

Selection on which channel you want to set the configuration

At this time we are in configuration mode and it is possible to navigate and select parameters desired:

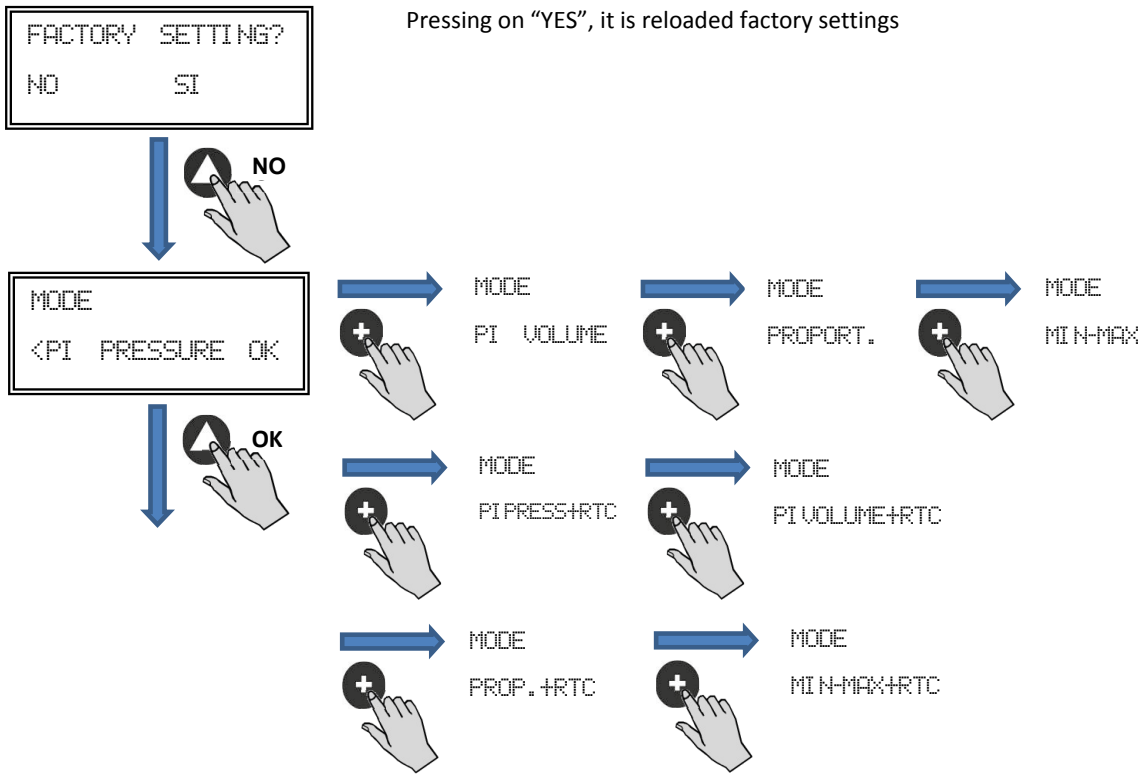

Operation: depending on mode selected, displayed parameters will be specific to each one. Ending "RTC" modes are only in combination with programming schedule TIMER RTC accessory.

6.6.3. Operation PI PRESSURE/COP mode

In section 5 we have described that the fan comes from factory ready to work in constant pressure mode. However, it is also possible to connect an external pressure transducer (0-10V or 4-20mA) that should be connected to J5 or J6 terminals.

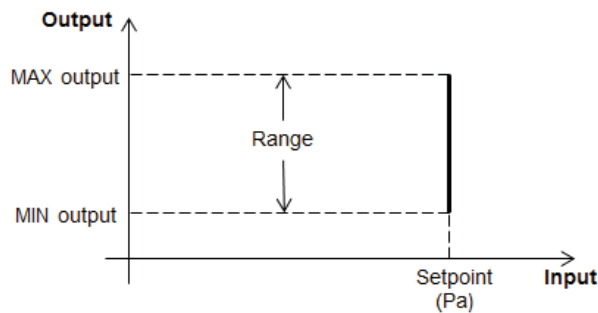

Operation PI PRESSURE/COP mode

After selecting the operating PI PRESSURE/COP mode, you can configure following parameters:



Press **+** or **-** to manually modify the minimum output parameter to the motor

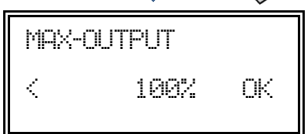
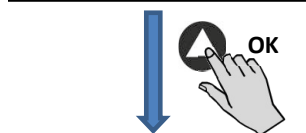

Press **+** or **-** to manually modify the maximum output parameter to the motor

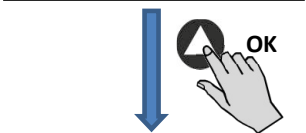

SETUP LEVEL 2?
< NO SI

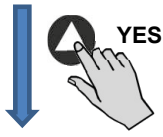

Access to advanced configuration parameters

ENTER PASSWORD:
1 1 1 OK

Enter the password

Default: 1 1 1

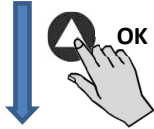

CHANGE PASSWORD
SI NO

It is possible to assign a new password to your device (channel)

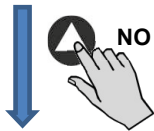

MOTOR TYPE
< EC OK

No modify



SENSOR
< INTERNAL OK

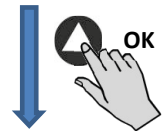

SENSOR
<IN1 0-10V OK



SENSOR
<IN1 4-20mA OK



SENSOR
<IN2 0-10V OK



SENSOR
<IN2 4-20mA OK

Sensor: Sensor type

- **INTERNAL:** Pressure differential internal sensor
- **IN1 0-10V:** External sensor with analog signal 0-10V (J5 terminal)
- **IN1 4-20mA:** External sensor with analog signal 4-20mA (J5 terminal)
- **IN2 0-10V:** External sensor with analog signal 0-10V (J6 terminal)
- **IN2 4-20mA:** External sensor with analog signal 4-20mA (J6 terminal)

RANGE
< 400Pa OK



Pulsar **+** o **-** para modificar manualmente el parámetro. El valor que aparece en pantalla corresponde a la escala del sensor interno preajustado en fábrica. Si se instala un sensor externo, introducir el rango de escala correspondiente.

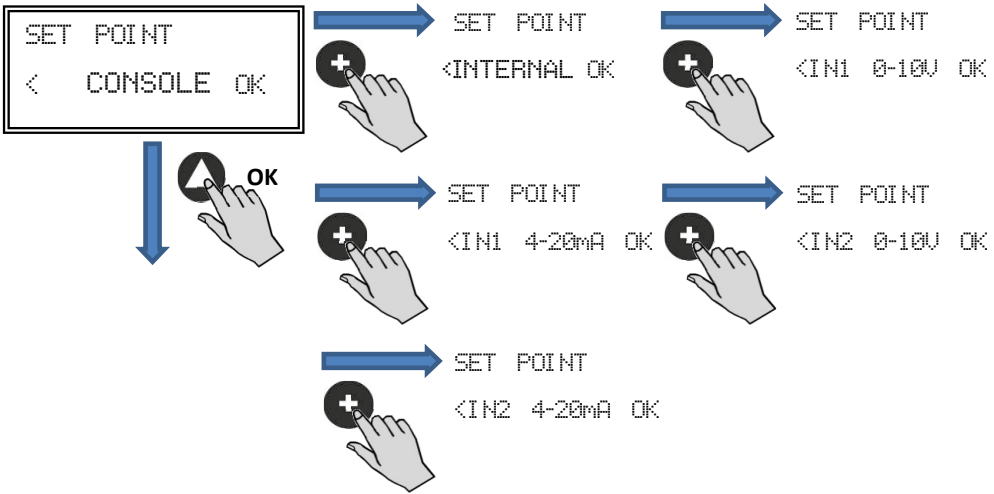

Set Point:

- **INTERNAL**
- **CONSOLE:** Value set by PROSYS ECOWATT console. Factory set value
- **IN1/IN2 0-10V:** Value set by external potentiometer (0-10V)
- **IN1/IN2 4-20mA:** Value set by external potentiometer (4-20mA)

Press **+** or **-** to manually modify this parameter.
It is advised not to modify.

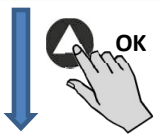
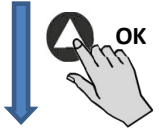
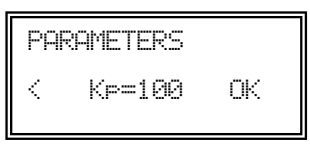

Press **+** or **-** to manually modify this parameter. **It is advised not to modify.**

Press **+** or **-** to manually modify this parameter. **It is advised not to modify.**

Press **+** or **-** to manually modify this parameter. This value corresponds to the % of pressure set point being the fan in night mode. To connect a time clock or potential-free switch to the digital input J11

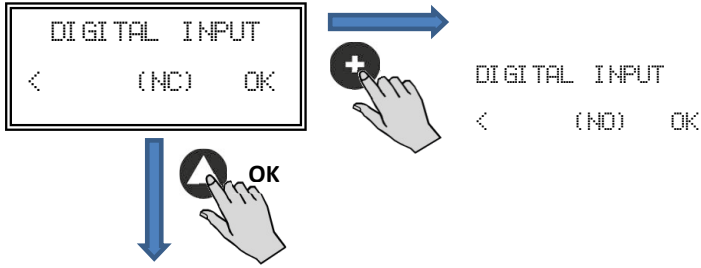

Digital input:

- **NC:** Normally closed contact. The fan will pass to night mode when contact is opened.
- **NO:** Normally open contact. The fan will pass to night mode when contact is closed.

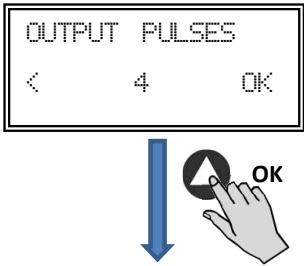

Press **+** or **-** to manually modify parameter that displays the speed by J8 output (TACOM). **It is advised not to modify default value.**

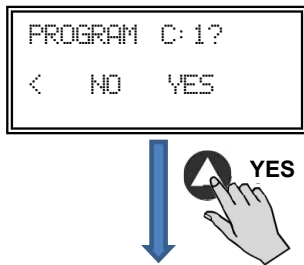

Save parameters modified

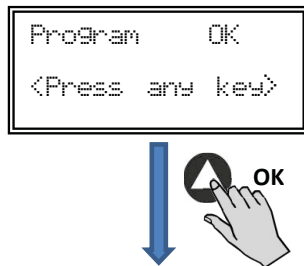

Press any key to return to main screen

6.6.4. Operation PI VOLUME/CAV mode

Before selecting PI VOLUME/CAV mode using PROSYS ECOWATT console, it is necessary to change pressure taps configuration. Place tubes marked with "V" and "P-" as is represented below CAB-125 ECOWATT model is not available with PI VOLUME/CAV mode).

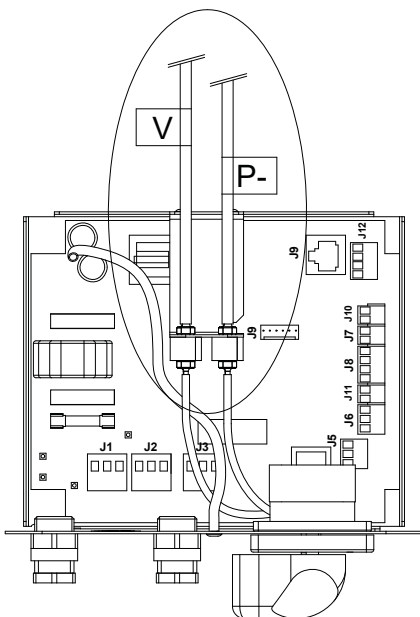

Constant pressupre (inlet side)

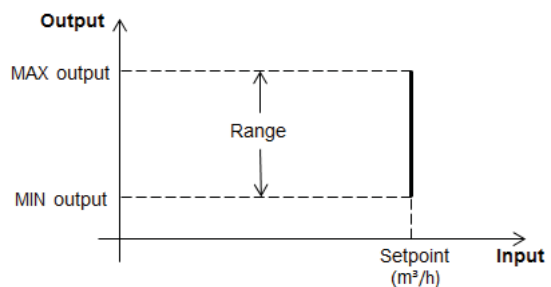

Constant pressupre

Once changed the operation mode to PI VOLUME/CAV, following parameters will appear:

EN

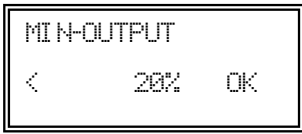

Press **+** or **-** to manually modify the minimum output parameter to the motor

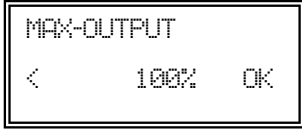
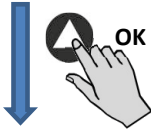

Press **+** or **-** to manually modify the minimum output parameter to the motor

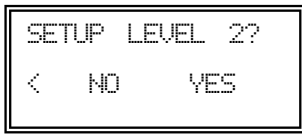
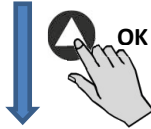

Access to advanced configuration parameters

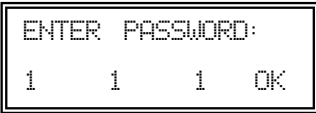
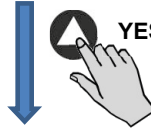

Enter the password

Default: 1 1 1

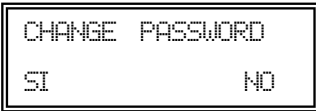

It is possible to assign a new password to your device (channel)

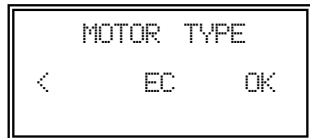
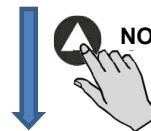

No modify

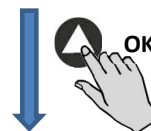

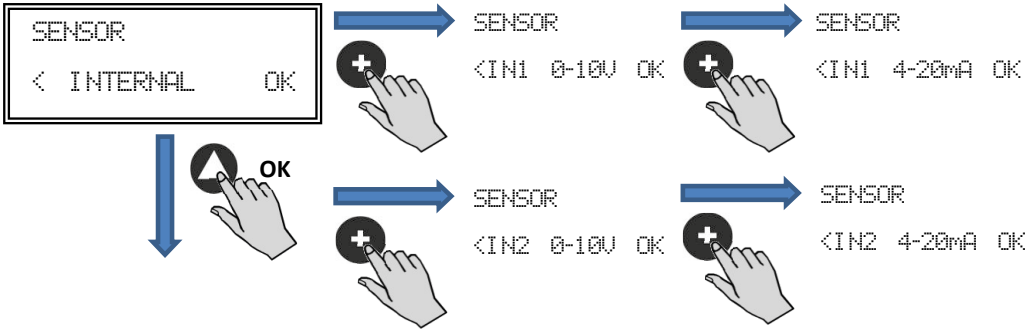

Sensor: Sensor type

- **INTERNAL:** Pressure differential internal sensor
- **IN1 0-10V:** External sensor with analog signal 0-10V (J5 terminal)
- **IN1 4-20mA:** External sensor with analog signal 4-20mA (J5 terminal)
- **IN2 0-10V:** External sensor with analog signal 0-10V (J6 terminal)
- **IN2 4-20mA:** External sensor with analog signal 4-20mA (J6 terminal)



Press **+** or **-** to manually modify the parameter.
The value displayed corresponds to the scale of the internal sensor factory pre-set. In an external sensor is installed, introduce the corresponding range.

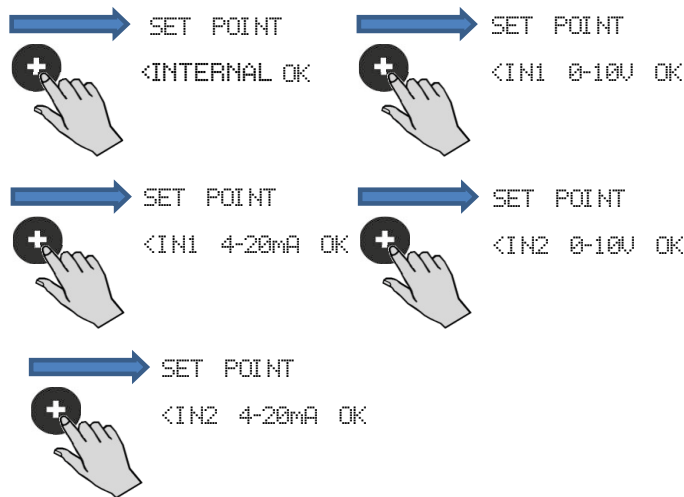
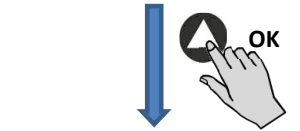

Set Point:

- **INTERNAL**
- **CONSOLE:** Value set by PROSYS ECOWATT console. Factory set value
- **IN1/IN2 0-10V:** Value set by external potentiometer (0-10V)
- **IN1/IN2 4-20mA:** Value set by external potentiometer (4-20mA)

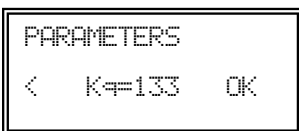

Press **+** or **-** to manually modify this parameter.
It is advised not to modify.



PARAMETERS
< Kp=100 OK

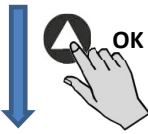

PARAMETERS
< Ki=20 OK



SENSOR IN1
< SIN SENSOR OK



SP-2 FLOW
< 50% OK



DIGITAL INPUT
< (NO) OK



DIGITAL INPUT
< (NO) OK

Press **+** or **-** to manually modify this parameter. **It is advised not to modify.**

Press **+** or **-** to manually modify this parameter. **It is advised not to modify.**

Press **+** or **-** to manually modify this parameter. **It is advised not to modify.**

Press **+** or **-** to manually modify this parameter. This value corresponds to the % of pressure set point being the fan in night mode. To connect a time clock or potential-free switch to the digital input J11

Digital input:

- **NC:** Normally closed contact. The fan will pass to night mode when contact is opened.
- **NO:** Normally open contact. The fan will pass to night mode when contact is closed.

OUTPUT PULSES
< 4 OK



Press **+** or **-** to manually modify parameter that displays the speed by J8 output (TACOM). **It is advised not to modify default value.**

```
PROGRAM C:1?
< NO YES
```

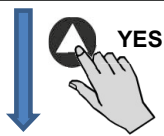

Save parameters modified

```
Program OK
<Pulsar tecla>
```

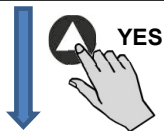

Press any key to return to main screen

6.6.5. Operation PROPORTIONAL/VAV mode

In this mode the control box is ready to work with one or two analog inputs (4-20mA or 0-10V). The control box works according to the parameter of maximum demand. Sensors are connected to the analog inputs J5 and/or J6.

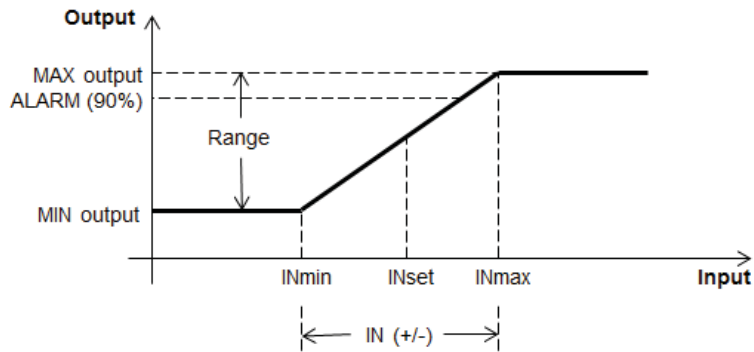

Operation PROPORTIONAL/VAV mode

Once changed the operation mode to PROPORTIONAL/VAV, following parameters will appear:

```
SENSOR IN1
< OFF OK
```

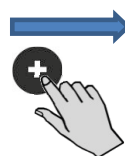

```
SENSOR IN1
< 0-10V%HR OK
```



```
SENSOR IN1
< 0-10VTempOK
```

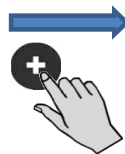

```
SENSOR IN1
< 0-10VCO2 OK
```

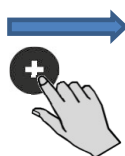

```
SENSOR IN1
< 4-20mA%HR OK
```



```
SENSOR IN1
< 4-20mATempOK
```

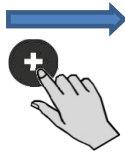

```
SENSOR IN1
< 4-20mACO2 OK
```

Sensor IN1:

- **NO SENSOR:** No sensor connected to this input
- **0-10V/4-20mA %HR:** Humidity sensor with output analog signal 0-10V/4-20mA
- **0-10V/4-20mA TEMP:** Temperature sensor with output analog signal 0-10V/4-20mA
- **0-10V/4-20mA CO2:** CO2 sensor with analog signal 0-10V/4-20mA

INI RANGE
< 100%HR OK



Press **+** or **-** to modify the scale of the external sensor used

INI SET
< 50%HR OK

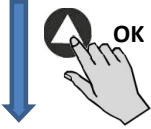

Press **+** or **-** to modify manually the middle range of use.

INI (+/-)
< 25%HR OK

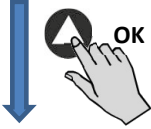

Press **+** or **-** to modify manually the width value of the adjustment range of the sensor

Follow the same process if you select a different sensor type or activated the second input analog signal SENSOR IN2.

MIN-OUTPUT
< 20% OK

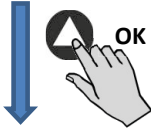

Press **+** or **-** to manually modify the minimum output parameter to the motor

MAX-OUTPUT
< 100% OK

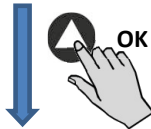

Press **+** or **-** to manually modify the maximum output parameter to the motor

SETUP LEVEL 2?
< NO YES

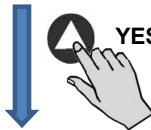

Access to advanced configuration parameters

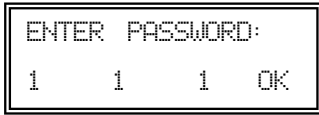

Enter the password

Default: 1 1 1



It is possible to assign a new password to your device (channel)

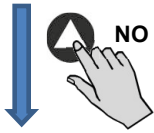

No modify

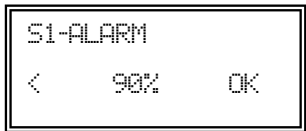
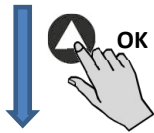

Press **+** or **-** to modify manually this parameter. This value allows you to send an alarm message when measured by sensor IN1 value reaches a percentage of measuring range



Press **+** or **-** to modify manually this parameter. This value allows you to send an alarm message when measured by sensor IN2 value reaches a percentage of measuring range

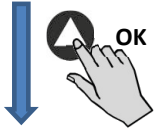

Press **+** or **-** to modify manually this parameter. This send an alarm message when the fan speed value reaches a minimum value

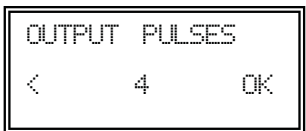
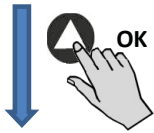

Press **+** or **-** to manually modify parameter that displays the speed by J8 output (TACOM). **It is advised not to modify default value.**

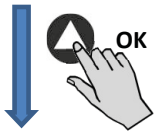

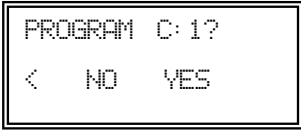

Save parameters modified

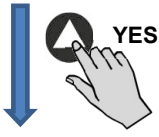

Press any key to return to main screen

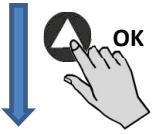

6.6.6. MIN/MAX operation mode

In this mode, the control box is ready to work by contact type normally open (NO) or normally closed (NC), located at the digital input J11. When the status of this input changes, the fan goes to low speed with a set value in % of maximum speed.

Logic:

- NO (normally open): The fan pass to low speed when contact is closed.
- NC (normally closed): The fan pass to low speed when contact is open.

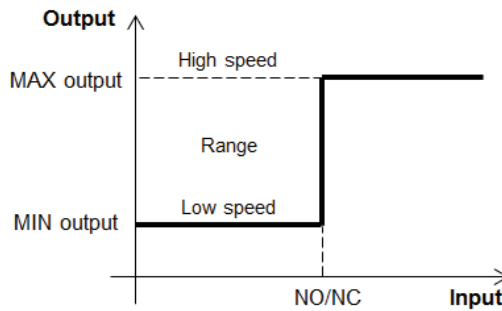

Operation mode MIN/MAX

Once changed the operation mode to MIN/MAX, following parameters will appear:

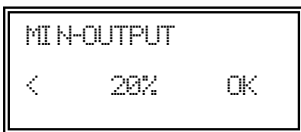

Press **+** or **-** to manually modify the minimum output parameter to the motor

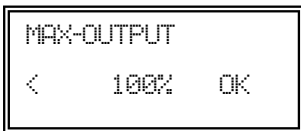
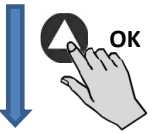

Press **+** or **-** to manually modify the maximum output parameter to the motor



SETUP LEVEL 2?
< NO YES

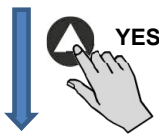

Access to advanced configuration parameters

ENTER PASSWORD:
1 1 1 OK



Enter the password

Default: 1 1 1

CHANGE PASSWORD
YES NO

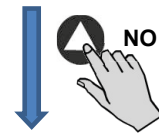

It is possible to assign a new password to your device (channel)

MOTOR TYPE
< EC OK

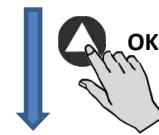

No modify

DIGITAL INPUT
< (NO) OK



Digital input:

- **NC:** Normally closed contact. The fan will pass to night mode when contact is opened.
- **NO:** Normally open contact. The fan will pass to night mode when contact is closed.

Press **+** or **-** to manually modify parameter that displays the speed by J8 output (TACOM).

It is advised not to modify default value.

OUTPUT PULSES
< 4 OK



PROGRAM C:1?
< NO YES



Save parameters modified

Program OK
<Press any key>

Press any key to return to main screen

7. OPERATION WITH TIMER RTC ECOWATT ACCESSORY AND PROSYS ECOWATT CONSOLE ACCESSORY

Acquiring the programming Schedule **TIMER RTC ECOWATT** offered and accessory, you will have access to functions described in section 6 *Operation with PROSYS ECOWATT* accessory console, in addition to program the following:

- **Up to three periods per day with desired set pointa**
- **Holiday period** by scheduling date and start/end time and % over maximum speed

7.1. INSTALLATION

As shown in figure below, this accessory is an electronic component that must be installed inside the roof fan control box.

In order to do it correctly, follow these steps:

1. Disconnect power supply from the frontal ON/OFF switch
2. Open control box
3. Locate the J4 connector

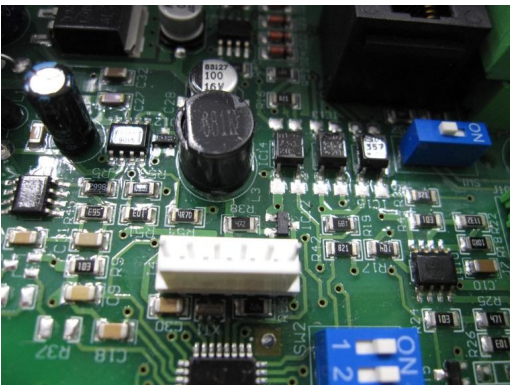

4. Line up electronic component TIMER RTC ECOWATT with J4 connector pins

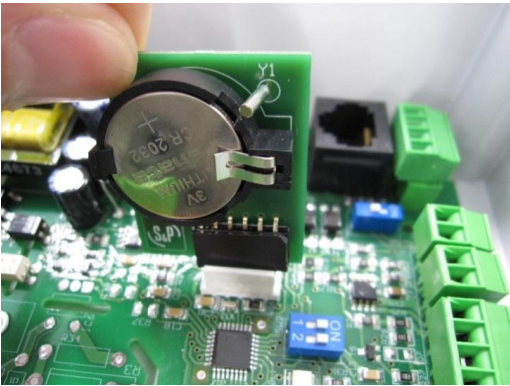

5. Fit the accessory pressing down



TIMER RTC ECOWATT

NOTE: Once installed, click twice the button  on the console PROSYS ECOWATT to display date and time.

7.2. PROGRAMMING

IMPORTANT: Before starting programming, it is important to select the appropriate operation mode. Check point 6.6.1. Change operation mode of this manual and choose one of these modes: *PI PRESS+RTC*, *PI VOLUME+RTC*, *PROPORT.+RTC* or *MIN-MAX+RTC*.

During programming process must define following parameters:

- **T1, T2, T3:** Start time for each period frame (OFF,00:00-23:59).
- **Period T1, Period T2, Period T3:** Minutes of each time period related to start time defined (until 480 minutes).
- **Set point T1, Set point T2, Set point T3:** Set point in % during period frame over operation mode previously selected (e.g. if *PI PRESSURE+RTC* mode is selected and set point T1 is 50%, during period frame the fan will reduce the speed accordingly with a minus 50% of the pressure set point defined SC).

Example:

	MONDAY	TUESDAY	...	SATURDAY	SUNDAY
1:00	T3 = 480 min SetpointT3 = 25%	T3 = 480 min SetpointT3 = 25%	...	T3 = 480 min SetpointT3 = 25%	T3 = 480 min SetpointT3 = 25%
2:00					
3:00					
4:00					
5:00					
6:00					
7:00					
8:00				T1 = 60min SetpointT1 = 50%	T1 = 60min SetpointT1 = 50%
9:00				T2 = 120 min SetpointT1 = 50%	T2 = 120 min SetpointT1 = 50%
10:00	T1 = 60min SetpointT1 = 50%	T1 = 60min SetpointT1 = 50%			
11:00					
12:00					
13:00					
14:00	T2 = 120 min SetpointT1 = 50%	T2 = 120 min SetpointT1 = 50%			
15:00					
16:00					
22:00					
23:00	T3 = 480 min SetpointT3 = 25%	T3 = 480 min SetpointT3 = 25%		T3 = 480 min SetpointT3 = 25%	T3 = 480 min SetpointT3 = 25%
0:00					

When one of these modes is selected, start programming with following sequence:

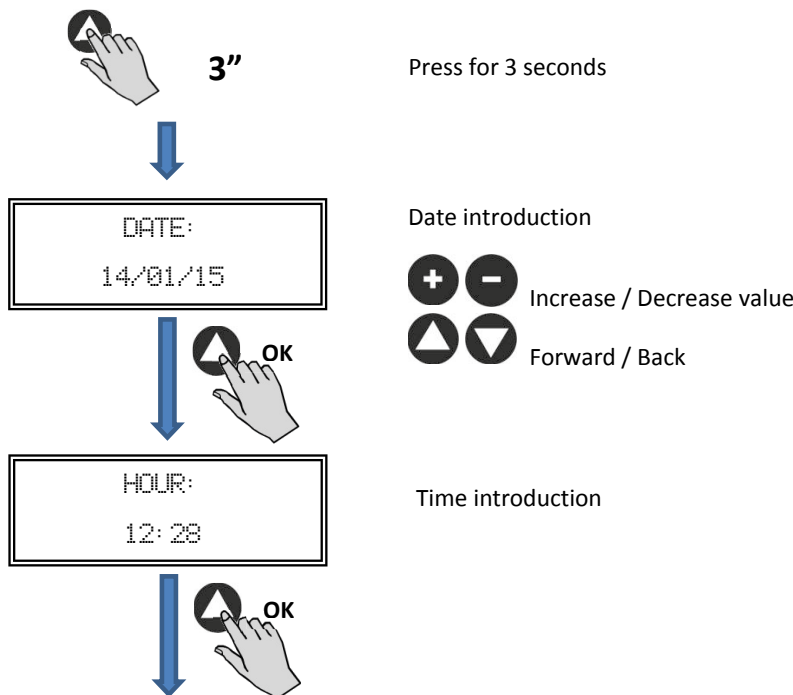

EXIT?
CONT YES

Pressing on YES, back to main screen
Pressing on CONT, continue programming

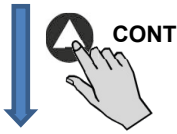

MONDAY
T1 09:00

Start time for period frame T1 on Monday

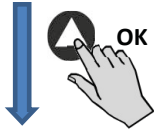

MONDAY
T2 11:00

Start time for period frame T2 on Monday



MONDAY
T3 14:00

Start time for period frame T3 on Monday

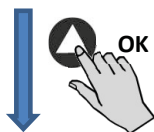

TUESDAY
NO SAME? SI

Accepting, Monday scheduling is copied on Tuesday

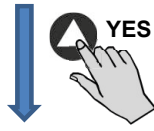

PERIOD T1
5 m

Time period introduction T1 (0 – 480 min)

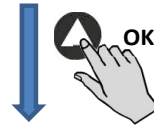

PERIOD T2
15 m

Time period introduction T2 (0 – 480 min)

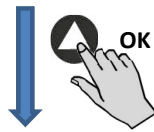

SET T1
80

Set point in % during period frame over operation mode previously selected (OFF, 0-100%)

Forward sequence

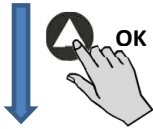

DATE START
19/12/14

Starting date holidays period

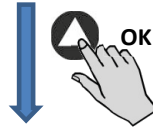

HOUR START
14:58

Starting time holidays period

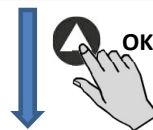

DATE END
30/12/14

Ending date holidays period



HOUR END
20:00

Ending hour holidays period

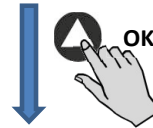

SET HOLIDAYS
20%

% over the set point for holidays period



EXIT?
NO YES

Confirm settings



Program OK
<Press any key>

Programming validation



7.3. SUMMARY TABLE SETTING VALUES

Registro	Min.	Max.	Description
T1 T2 T3	OFF	23:59	Start time period frame
Period T1 Period T2 Period T3	0min	480min	Period frame duration
Set T1 Set T2 Set T3	OFF	100%	Percentage over set point
Date start	00:00	23:59	Starting date holidays period
Hour start	00:00	23:59	Starting hour holidays period
Date end	00:00	23:59	Ending date holidays period
Hour end	00:00	23:59	Ending hours holidays period
Set Holidays	OFF	100%	Percentage over the set point for holidays period

8. MODBUS COMMUNICATION SYSTEM INTEGRATION

8.1. BASIC FEATURES OF MODBUS-RTU CONTROL

Addressing	Slave: configurable address from 1 to 247	Master: able to address slaves with address from 1 to 247
Diffusion	Yes	
Transmissions speed	9600 (19200 is recommended too)	
Parity	PAR/EVEN	
Mode	RTU	
Electrical interface	RS485 2W-wired or RS232	
Connector type	RJ 45	

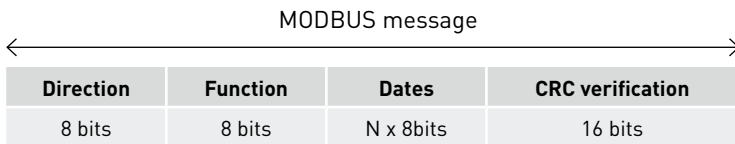

Format for each byte in RTU mode is:

- System codes: 8-bit binary
- Bits per Byte: 1 bit to START (start)
8 bits for data, the most significant bit is sent first
1 bit for parity (Even parity is required)
1 bit for STOP (end)

8.2. MODBUS MEMORY MAP

Holding registers

N°REG.	Register	Min.	Max.	Description	Default	Comments
0	TipoMotor	0	1	0=AC 1=DC	1	Motor type
1	ModoFun	0	7	0=PI_Presión 1=PI_Caudal 2=Proporcional 3=Max-Min 4=PI_Presión+RTC 5=PI_Caudal+RTC 6=Proporcional+RTC 7=Max-Min+RTC	0	Operation mode
2	SensorPI	0	4	0=Interno 1=IN1 0-10V 2=IN1 4-20mA 3=IN2 0-10V 4=IN2 4-20mA	0	Sensor type in PI PRESSURE or PI VOLUME mode
3	Sensor1	0	7	0=NO 1=0-10V %HR 2=4-20mA %HR 3=0-10V °C 4=4-20mA °C 5=0-10V CO2 6=4-20mA CO2 7=NTC 100K	0	Sensor type in PROPORTIONAL mode and analog input signal 1
4	Sensor2	0	6	0=NO 1=0-10V %HR 2=4-20mA %HR 3=0-10V °C 4=4-20mA °C 5=0-10V CO2 6=4-20mA CO2	0	Sensor type in PROPORTIONAL mode and analog input signal 2
5	PIRange	50 50 100	1250 2500 9900	SensorPI=0 SensorPI<>0 Sensor<<>0	400 (CAB-125/150/160 ECOWATT) 500 (CAB-200/315 ECOWATT) 650 (CAB-250 ECOWATT) 550 (CAB-355/400 ECOWATT)	Range sensor in PI PRESSURE mode
6	SetPoint	0	5	0=Interno 1=IN1 0-10V 2=IN1 4-20mA 3=IN2 0-10V 4=IN2 4-20mA 5=ConsolaMODBUS (PROSYS ECOWATT)	5	Set point in PI PRESSURE mode
7	Kp	1	250	Increases 1	20	Proportional constant in PI PRESSURE mode
8	Ki	1	250	Increases 1	20	Integral constant in PI PRESSURE mode
9	Kq	50	300	Increases 1	50 (CAB-125 ECOWATT) 56 (CAB-150/160 ECOWATT) 81 (CAB-200 ECOWATT) 88 (CAB-250 ECOWATT) 108 (CAB-315 ECOWATT) 136 (CAB-355 ECOWATT) 81 (CAB-400 ECOWATT)	Airflow constant with pressure sensor
10	PulsosEncoder	0	16	Increases 1	2 5 1	Number of pulses for encoder lap
11	MinOut	0	50	Increases 5%	25	Minimum output value
12	MaxOut	50	100	Increases 5%	100	Maximum output value
13	S1Alarm	0	100	Increases 5%	90	Analog input 1 alarm
14	S2Alarm	0	100	Increases 5%	90	Analog input 2 alarm

NºREG.	Register	Min.	Max.	Description	Default	Comments
15	MinRPM	100	500	Increases de 100	300	Min RPM alarm
16	VacMIN	80	150	Increases de 10	80	Minimum voltage AC motor
17	IN1 Range	0 0 0	100 50 2000	%HR incrementos °C incrementos PPM incrementos	100	Background scale in proportional mode input 1
18	IN2 Range	0 0 0	100 50 2000	%HR Increases °C Increases PPM Increases	2000	Background scale in proportional mode input 2
19	IN1 Set	0	IN1 Range	Increases de 1	70	Set point proportional mode input 1
20	IN1 Banda	0	IN1 Range	Increases de 1	40	Margin (+/-) centered in IN1 Set
21	IN2 Set	0	IN2 Range	Increases de 1	1000	Set point proportional mode input 2
22	IN2 Banda	0	IN2 Range	Increases de 1	1000	Margin (+/-) centered in IN2 Set
23	InD	0	1	0=NO 1=NC	0	Digital input inverter
24	setMODBUS	1	PIRange	Increases de 50	100 (CAB-125 ECOWATT) 150 (CAB-150/160/200/150/315 ECOWATT) 200 (CAB-355/400 ECOWATT)	MODBUS set point
25	IDIOMA	0	3	0=ENGLISH 1=SPANISH 2=FRENCH 3=GERMAN	0	Language
26	SP-2 PRESION	25	100	Increases de 1	25	Night set point in PI PRESSURE mode
27	SP-2 CAUDAL	50	100	Increases de 1	50	Night set point in PI VOLUME mode
28	SP Temp	-10	50	Increases de 1		Temperature set point (only for CTBH ECOWATT models)
29	adMODBUS	1 0	247 100	Increases de 1	1	
30	ALARMA	0	1			
31	FECHA	0x0000	0xfe7f	Day/Month/Year	0x088E	Current date
32	HORA	0x0000	0x3dfb	Hour/Minute	0x0000	Current date
33	LUNES T1	0x0000	0x063b	Hour/Minute	0x0200	Starting period 1 Monday
34	LUNES T2	0x0000	0x063b	Hour/Minute	0x0300	Starting period 2 Monday
35	LUNES T3	0x0000	0x063b	Hour/Minute	0x0480	Starting period 3 Monday
36	MARTES T1	0x0000	0x063b	Hour/Minute	0x0200	Starting period 1 Tuesday
37	MARTES T2	0x0000	0x063b	Hour/Minute	0x0300	Starting period 2 Tuesday
38	MARTES T3	0x0000	0x063b	Hour/Minute	0x0480	Starting period 3 Tuesday
39	MIERCOLES T1	0x0000	0x063b	Hour/Minute	0x0200	Starting period 1 Wednesday
40	MIERCOLES T2	0x0000	0x063b	Hour/Minute	0x0300	Starting period 2 Wednesday
41	MIERCOLES T3	0x0000	0x063b	Hour/Minute	0x0480	Starting period 3 Wednesday
42	JUEVES T1	0x0000	0x063b	Hour/Minute	0x0200	Starting period 1 Thursday
43	JUEVES T2	0x0000	0x063b	Hour/Minute	0x0300	Starting period 2 Thursday
44	JUEVES T3	0x0000	0x063b	Hour/Minute	0x0480	Starting period 3 Thursday
45	VIERNES T1	0x0000	0x063b	Hour/Minute	0x0200	Starting period 1 Friday
46	VIERNES T2	0x0000	0x063b	Hour/Minute	0x0300	Starting period 2 Friday

N°REG.	Register	Min.	Max.	Description	Default	Comments
47	VIERNES T3	0x0000	0x063b	Hour/Minute	0x0480	Starting period 3 Friday
48	SABADO T1	0x0000	0x063b	Hour/Minute	0x0200	Starting period 1 Saturday
49	SABADO T2	0x0000	0x063b	Hour/Minute	0x0300	Starting period 2 Saturday
50	SABADO T3	0x0000	0x063b	Hour/Minute	0x0480	Starting period 3 Saturday
51	DOMINGO T1	0x0000	0x063b	Hour/Minute	0x0200	Starting period 1 Sunday
52	DOMINGO T2	0x0000	0x063b	Hour/Minute	0x0300	Starting period 2 Sunday
53	DOMINGO T3	0x0000	0x063b	Hour/Minute	0x0480	Starting period 3 Sunday
54	TIEMPO T1	0	480	1	60	Time in minutes for period 1
55	TIEMPO T2	0	480	1	60	Time in minutes for period 2
56	TIEMPO T3	0	480	1	60	Time in minutes for period 3
57	CONSIGNA T1	0	100	1	80	Percentage about set point
58	CONSIGNA T2	0	100	1	60	Percentage about set point
59	CONSIGNA T3	0	100	1	100	Percentage about set point
60	FECHA INICIO	0	0xfe7f	Day/Month/Year	0x088E	Starting date holiday period
61	HORA INICIO	0x0000	0x063b	Hour/Minute	0	Starting hour/minute holiday period
62	FECHA FIN	0	0xfe7f	Day/Month/Year	0x088E	Ending date holiday period
63	HORA FIN	0x0000	0x063b	Hour/Minute	0	Ending hour/minute holiday period
64	CONSIGNA VAC	0	100	1	20	Holiday period set point
65	VERSION	0	250	1		Read-only
66	BAUDRATE	0	3	0=19200 1=9600 2=4800 3=2400	1	Transmission speed
67	PARIDAD	0	2	0=No 1=Even 2=Odd	1	Parity MODBUS network

Input registers (Read-only)

Register	Min.	Max.	Description	Default	Comments	Comments
0	Pote	0	255	Potentiometer RV1 PCB		Potentiometer RV1
1	In1	0	255	Analog input 1		Entrada Analógica 2
2	In2	0	255	Analog input 2		Entrada Analógica 2
3	Interno	0	1250	Internal pressure sensor		Internal pressure sensor
4	Rpm	0	6000	Motor speed		Speed motor (if rpm<100, rpm=0)

Discrete inputs (Read-only)

Register	Min.	Max.	Description	Default	Comments	Comments
0	InD	0	1	Digital input		Digital input

Output coils (sólo lectura)

Register	Min.	Max.	Description	Default	Comments	Comments
0	Output	0	1	Relay		Relay

9. MAINTENANCE

Before manipulating the fan, make sure it is disconnected from the mains supply even if it has previously been switched off. Prevent the possibility of anyone else connecting it while it is being manipulated.

Fan unit must be regularly inspected. These inspections should be carried out bearing in mind the machine's working conditions, in order to avoid dirt or dust accumulating on blades, impeller, motor or grids. This could be dangerous and perceptibly shorten the working life of fan unit.

While cleaning, great care should be taken not to unbalance blades or impeller.

All maintenance and repair work should be carried out in strict compliance with each country's current safety regulations.

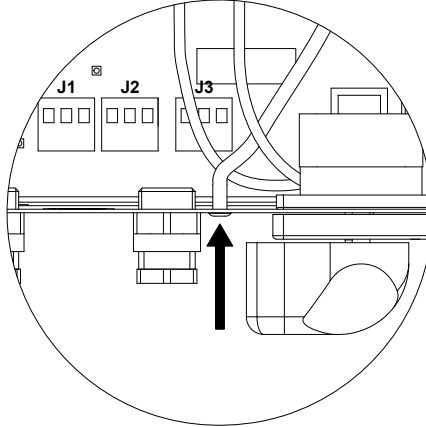

Check the cleanliness of the ambient pressure tube hole. Accumulation of dirt will falsify the reading and cause abnormal operation.

10. PUTTING OUT OF SERVICE AND RECYCLING



EEC legislation and our consideration of future generations mean that we should always recycle materials where possible; please do not forget to deposit all packaging in the appropriate recycling bins. If your device is also labeled with this symbol, please take it to the nearest Waste Management Plant at the end of its servicable life.

SOMMAIRE

1. GÉNÉRALITÉS.....	68
2. NORMES DE SECURITES ET MARQUAGE “CE”.....	68
3. NORMES GENERALES.....	68
4. DESCRIPTION.....	69
4.1. Emplacements.....	69
4.2. Branchement électrique et détail plaque interne.....	70
5. FONCTIONNEMENT SANS CONSOLE PROSYS ECOWATT.....	71
6. FONCTIONNEMENT AVEC ACCESSOIRE CONSOLE PROSYS ECOWATT.....	71
6.1. Description.....	72
6.2. Utilisation de la console.....	72
6.3. Installation.....	73
6.4. Paramètres généraux.....	76
6.5. Mise en marche du système.....	76
6.6. Configuration des équipements par la console.....	77
6.6.1. Changement de Consigne.....	77
6.6.2. Changement de mode de fonctionnement.....	77
6.6.3. Fonctionnement mode PI PRESSION/COP.....	78
6.6.4. Fonctionnement mode PI DÉBIT /CAV.....	81
6.6.5. Fonctionnement mode PROPORTIONNEL / VAV.....	85
6.6.6. Fonctionnement mode MIN-MAX.....	88
7. FONCTIONNEMENT AVEC ACCESSOIRE DE PROGRAMMATION HORAIRE TIMER RTC ECOWATT AVEC L'ACCESSOIRE CONSOLE PROSYS ECOWATT.....	90
7.1. Installation.....	90
7.2. Programmation.....	91
7.3. Tableau résumé valeurs de réglage.....	94
8. INTÉGRATION DANS LE SYSTÈME DE COMMUNICATION MODBUS.....	94
8.1. Caractéristiques de base du contrôle Modbus-RTU.....	94
8.2. Plan de mémoire Modbus.....	95
9. MAINTENANCE.....	98
10. RECYCLAGE.....	98

1. GÉNÉRALITÉS

Avant d'installer et d'utiliser ce produit, lire attentivement ces instructions qui contiennent d'importantes indications pour votre sécurité et celle des utilisateurs, pendant l'installation, l'utilisation et l'entretien de ce produit. Une fois l'installation terminée, laisser ce manuel à la disposition de l'utilisateur final.

Dès réception, vérifier le parfait état de l'appareil étant donné que tout défaut d'origine est couvert par la garantie **S&P**. A la réception de celui-ci, nous vous conseillons vivement de vérifier qu'il n'a pas été endommagé pendant le transport. Dans ce cas, envoyer une lettre avec A.R. au transporteur. En effet, celui-ci est seul responsable des dégâts causés lors du transport. Ne pas laisser l'emballage à portée des enfants et le recycler en accord avec les normes en vigueur.

2. NORMES DE SECURITES ET MARQUAGE "CE"

Toujours à la pointe de l'innovation, nos équipes d'ingénieurs n'ont cessé de développer des produits de plus en plus performants conformes aux normes de sécurité en vigueur.

Les normes et conseils, contenus dans ce manuel, se réfèrent aux normes standards en application et par conséquent, sont basés sur la conformité avec les normes générales.

Ainsi, nous conseillons vivement à toutes les personnes concernées d'appliquer les règles en vigueur dans leurs pays en matière de prévention d'accidents.

La responsabilité de **S&P** ne saurait être engagée pour des éventuels dommages corporels et/ou matériels causés lorsque les consignes de sécurité n'ont pas été respectées ou suite à une modification du produit.

Le marquage **CE** ainsi que les déclarations de conformité certifient la conformité aux normes européennes en vigueur.

3. NORMES GENERALES

L'analyse des risques associée au produit a été réalisée comme prévu dans la Directive Machines.

Les dispositifs de protection ne doivent pas être enlevés sauf en cas d'absolue nécessité.

Dans ce cas, des mesures appropriées seront immédiatement adoptées pour signaler explicitement le danger. Dès que possible, les dispositifs de protection doivent impérativement être rétablis.

Toutes les interventions de maintenance (régulières ou occasionnelles) se feront alimentation électrique coupée.

Avant de brancher le câble d'alimentation électrique de l'appareil, il convient de s'assurer que la tension est conforme à celle indiquée sur le produit.

Le câble d'alimentation doit passer deux fois, une boucle, par la ferrite WE74271221 inclus dans l'emballage



4. DESCRIPTION

4.1. EMBLEMES

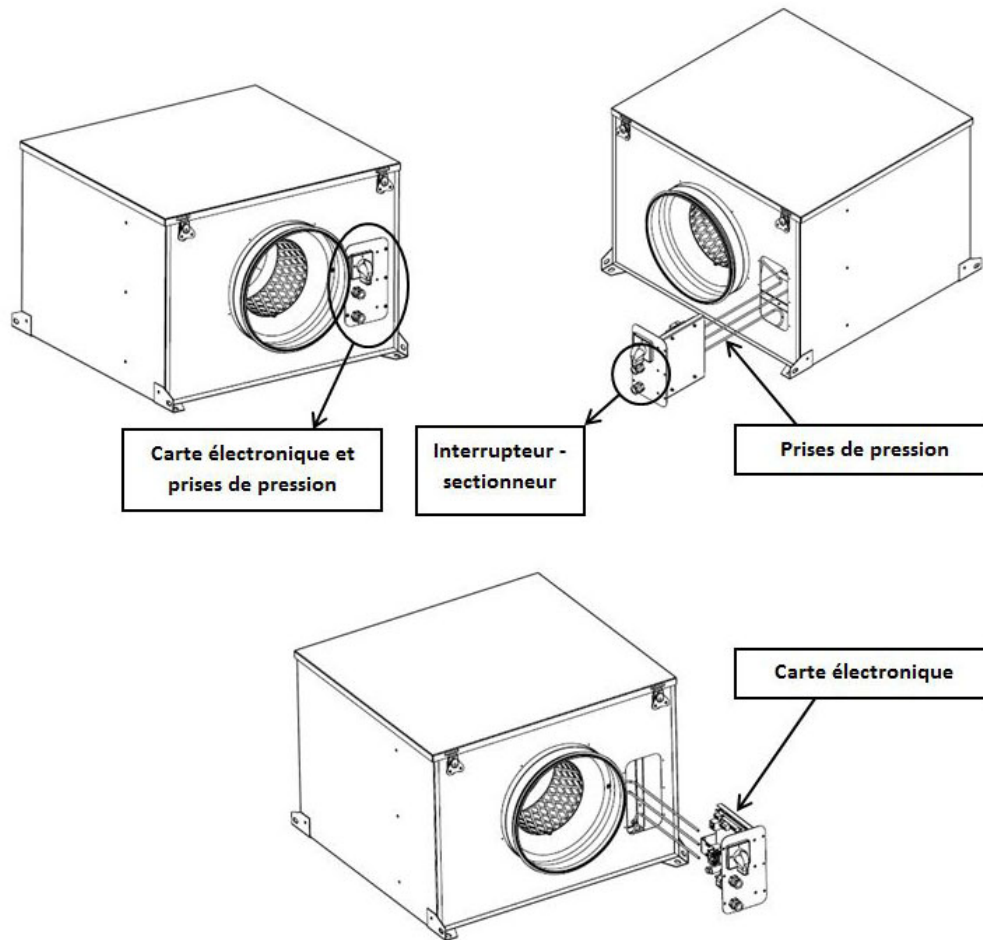

FR

IMPORTANT

À l'intérieur de l'emplacement pour le carte électronique vous pourrez voir trois tubes repérés par les lettres «V», «P-» et «P+» provenant de l'intérieur de l'extracteur de toit. L'équipement sort d'usine avec le tube marqué «P-» connecté avec le tube. Laissez cette installation en l'état sauf si vous avez lu au préalable le paragraphe 6.6.3 de ces instructions.

4.2. BRANCHEMENT ÉLECTRIQUE ET DÉTAIL PLAQUE INTERNE

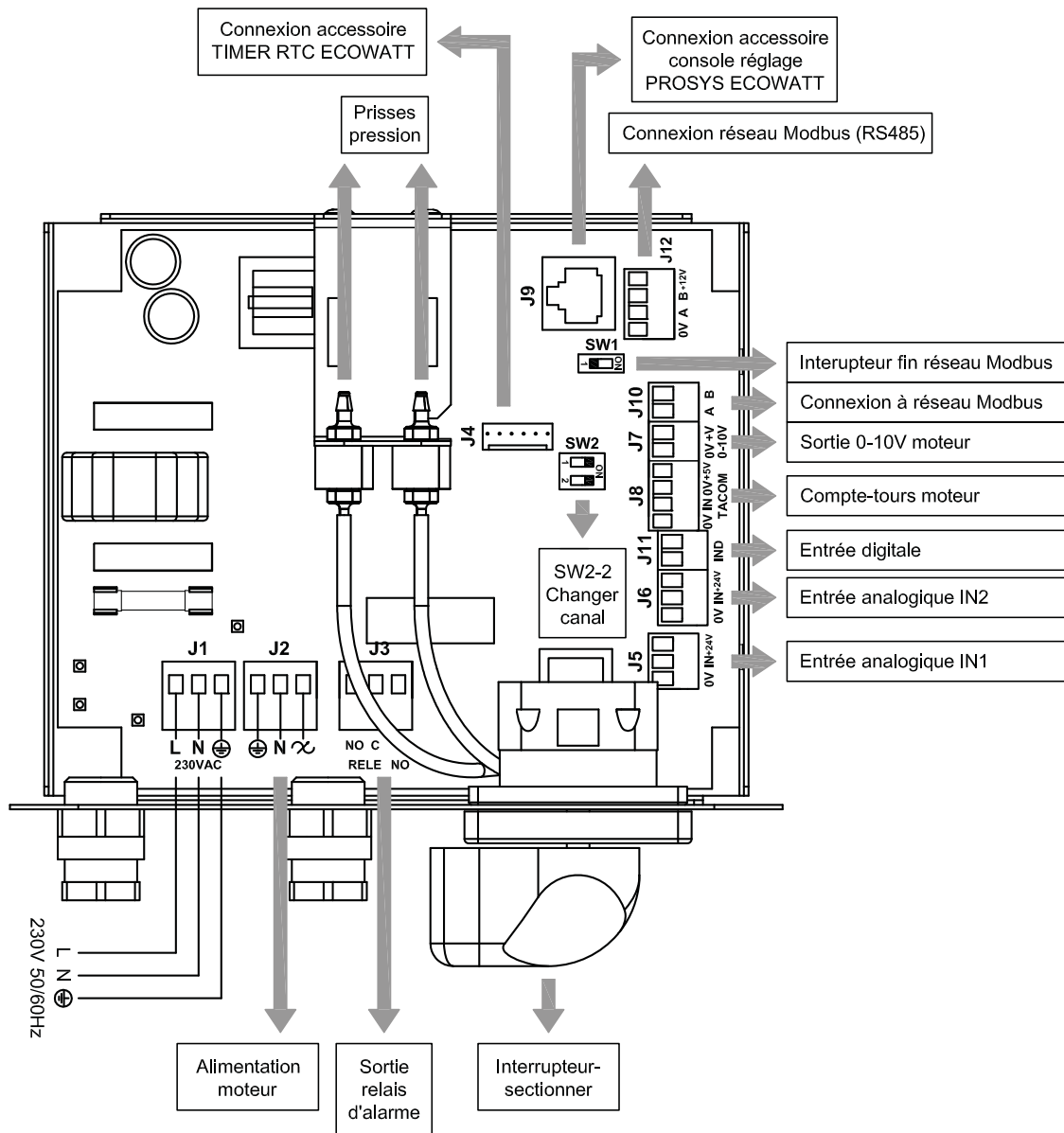

Entrées	Description
L, N, GND (J1)	Alimentation électrique. 220-230 V AC 50 Hz
Prise pression 1	Prise pour connecter conduit de pression selon mode de fonctionnement
Prise pression 2	
Connecteur (J4)	Entrée pour connexion à un accessoire de programmation horaire TIMER RTC ECOWATT
0V, IN, +24V (J5)	Entrée Analogique IN1 4-20 mA ou 0-10V.
0V, IN, +24V (J6)	Entrée Analogique IN2 4-20 mA ou 0-10V.
RJ45 (J9)	Entrée pour connexion à un accessoire de commande à distance PROSYS ECOWATT
IND (J11)	Entrée Numérique pour fonction nuit ou mode de fonctionnement MIN/MAX. À l'état ouvert, le ventilateur passe à la vitesse nuit ou vitesse minimale lorsque le contact se ferme. À l'état fermé, le ventilateur passe à la vitesse nuit ou vitesse minimale lorsque le contact s'ouvre.

Sorties	Description
GND, N, ⏏ (J2)	Alimentation plaque interne en passant par l'interrupteur (câblage en usine)
RELAIS (J3)	Commute avec l'activation de toute alarme (charge maximale 2A)
0V, +V (J7)	Sortie analogique 0-10V vers moteur
TACOM (J8)	Compte-tours moteur
A, B (J10)	Connexion à réseau de communication. Protocole Modbus
RS485 (J12)	Connexion à réseau de communication. Protocole Modbus

Micro- interrupteurs	Description
SW1	Résistance finale de ligne. Utilisation exclusive dans les réseaux de communication Modbus
SW2	SW2-2: habilitier changement canal

5. FONCTIONNEMENT SANS CONSOLE PROSYS ECOWATT

Les caissons acoustiques CAB ECOWATT PLUS sont conçus pour que le ventilateur travaille en mode pression constante (PI PRESSION/COP) par rapport à une lecture d'écart de pression prise sur l'aspiration et un consigne présélectionnée en usine.

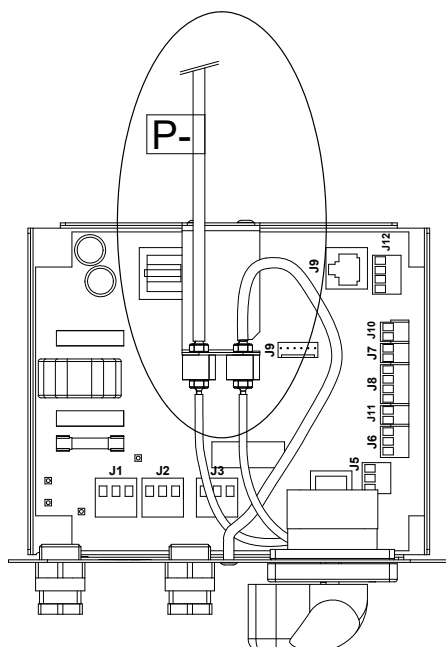

Pression constante (à l'aspiration) par défaut

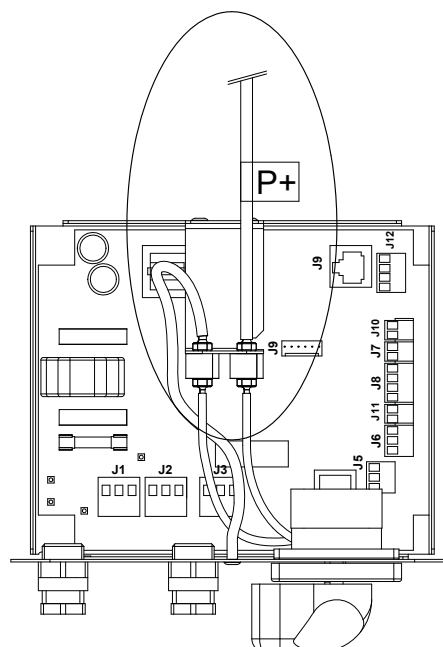

Pression constante (au soufflage)

Consigne de pression

Modèle	Consigne (Pa)
125	100
150	150
160	150
200	150
250	150
315	150
355	200
400	200

Le réglage d'usine est en pression constant à l'aspiration. Cependant, il est possible de le faire au soufflage.

6. FONCTIONNEMENT AVEC ACCESSOIRE CONSOLE PROSYS ECOWATT

En achetant la console PROSYS ECOWATT offerte comme accessoire, vous pourrez avoir accès aux modes de fonctionnement suivants:

- **Système de pression constante (PI PRESSION/COP)** avec des paramètres de consignes modifiables.
- **Système de débit d'air constant (PI CAUDAL/CAV)** avec des paramètres de consignes modifiables.
- **Système de débit d'air variable (PROPORCIONAL/VAV)** (il est nécessaire d'installer une sonde externe émettrice de signal analogique 0-10V ou 4-20 mA).
- **Système fonctionnement MIN/MAX** (il est nécessaire d'installer une sonde émettrice signal numérique, horloge ou contact extérieur).



PROSYS ECOWATT

6.1. DESCRIPTION

La console PROSYS ECOWATT est utilisée comme complément de visualisation et de contrôle. Elle permet de réaliser les fonctions suivantes:

- Voir les paramètres et les variables de l'équipement
- Enregistrer des configurations
- Voir les configurations
- Configurer l'équipement et ses modes de fonctionnement
- Rechercher des équipements (canaux) dans le réseau (ils doivent au préalable avoir été configurés avec des numéros de canaux différents)

La console dispose d'un écran LCD de 2x16 caractères, 4 boutons-poussoirs et 3 LED.

- Bouton-poussoir « En Haut »
- Bouton-poussoir « En Bas »
- Bouton-poussoir « + »
- Bouton-poussoir « - »
- LED alimentation ON
- LED « Activité » MODBUS
- LED erreur

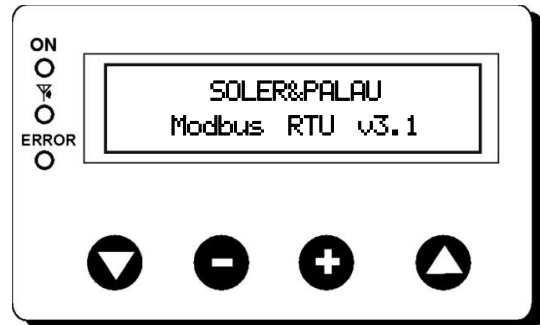

6.2. UTILISATION DE LA CONSOLE

Lorsqu'un paramètre configuré est modifié, les boutons-poussoirs de la console ont les fonctions suivantes:

Bouton-poussoir	Fonction
+	Augmente la valeur du paramètre
-	Diminue la valeur du paramètre
▲	Entrer
▼	Sortir

Lorsque vous naviguez dans les menus, la fonction du bouton-poussoir est différente et dépend des indications affichées à l'écran. Chaque bouton-poussoir exécute les fonctions indiquée juste dessus.

Exemples:

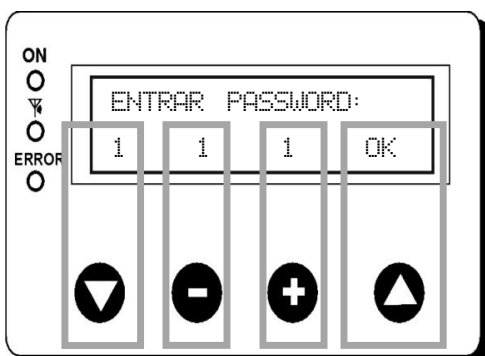

Bouton-poussoir	Fonction
▼	Modifie la valeur du 1er chiffre
-	Modifie la valeur du 2ème chiffre
+	Modifie la valeur du 3ème chiffre
▲	OK Valider

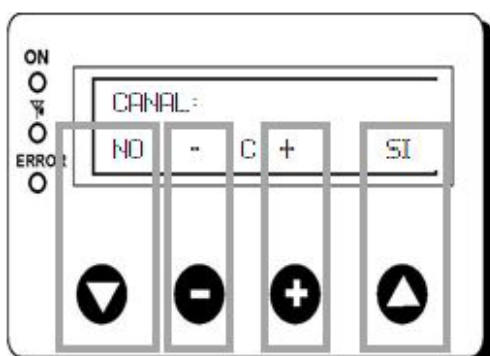

Bouton-poussoir	Fonction
▼	NON = quitter
-	Réduit la valeur du canal
+	Augmente la valeur du canal
▲	SI = Valider

6.3. INSTALLATION

Il est possible d'installer une seule console sur un CAB ECOWATT PLUS, ou de réaliser un réseau de communication Modbus en unissant plusieurs boîtiers de ventilation à une seule console PROSYS:

Schéma de branchement contrôle individuel



Schéma de branchement contrôle multiple

Il est possible de connecter jusqu'à 32 ventilateurs entre eux pour créer un réseau qui peut être ajusté et contrôlé avec une seule console PROSYS ECOWATT.

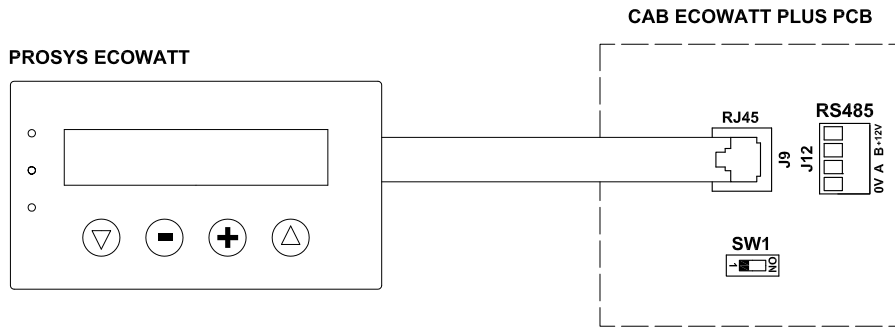
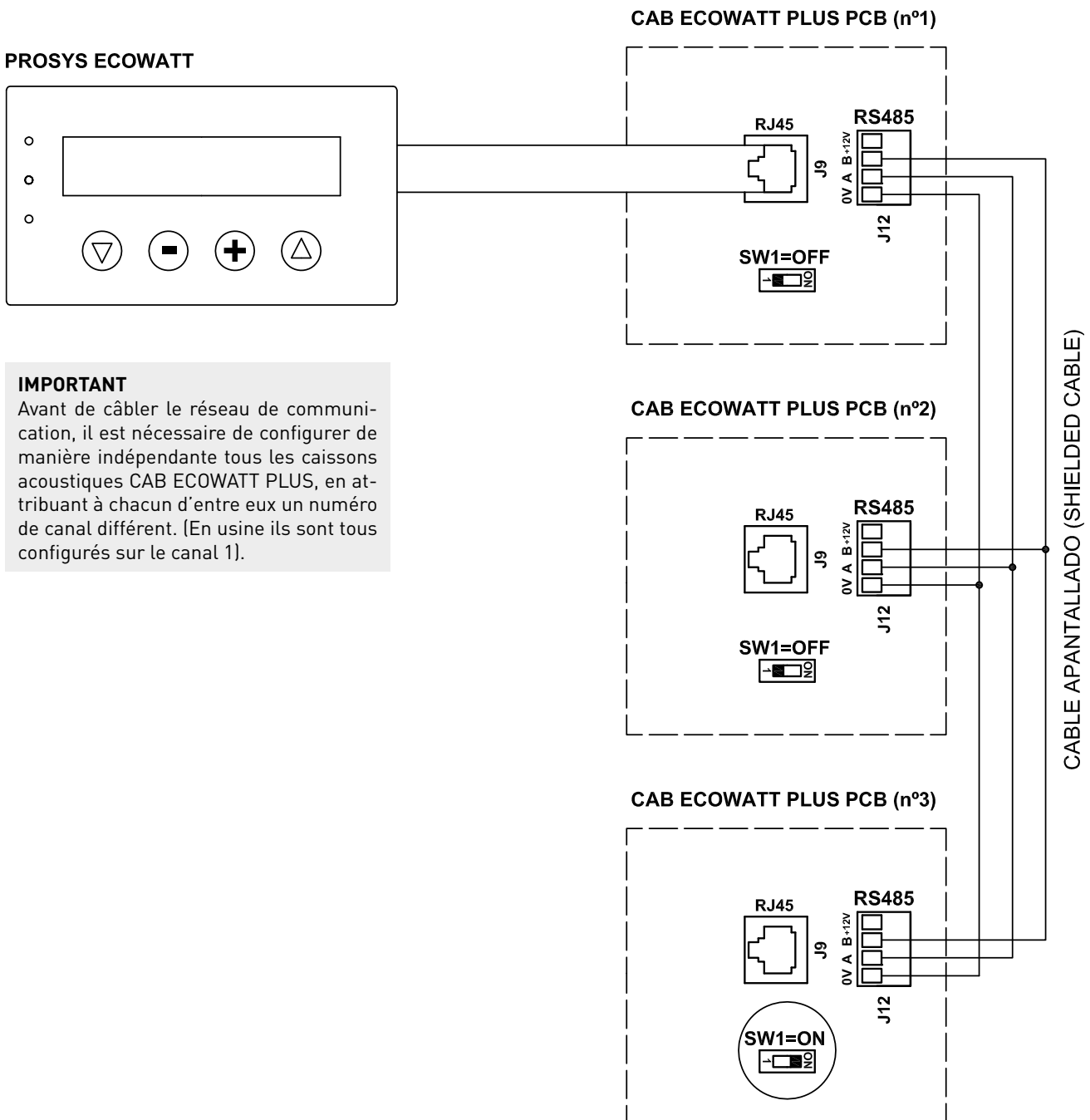

IMPORTANT

Avant de câbler le réseau de communication, il est nécessaire de configurer de manière indépendante tous les caissons acoustiques CAB ECOWATT PLUS, en attribuant à chacun d'entre eux un numéro de canal différent. (En usine ils sont tous configurés sur le canal 1).

Pour procéder au changement du numéro de canal-ventilateur, procédez comme suit:

- Vérifiez que l'interrupteur arrêt/marche est bien en position « 0 ».
- Accédez à la plaque interne et placez le micro-interrupteur SW2-2 sur « ON ».
- Connectez la console PROSYS ECOWATT sur la plaque interne par le connecteur J9
- Allumez l'appareil par l'interrupteur marche/arrêt
- Choisissez la langue souhaitée à l'écran de départ.
- Avancez dans les écrans de la console de la manière suivante:

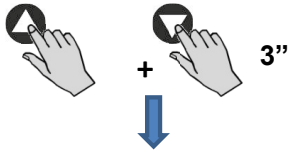

Appuyez simultanément pendant 3"

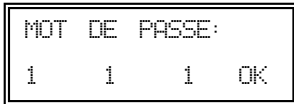

Indiquez le mot de passe d'accès spécifique du canal.
Par défaut: 1 1 1



Il est possible d'affecter un nouveau mot de passe à l'équipement

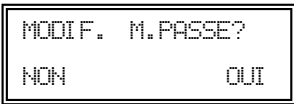

Sélection du canal sur lequel vous souhaitez le ventilateur

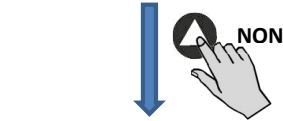

Appuyez sur "NON"

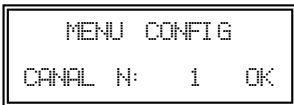

Appuyez sur "OK"

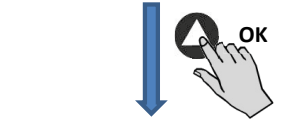

Appuyez sur "OK"

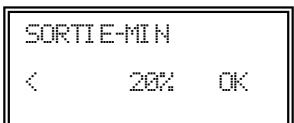
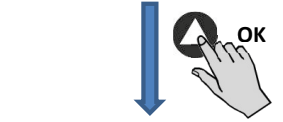
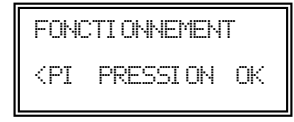
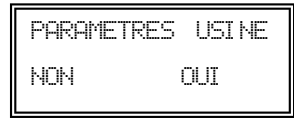

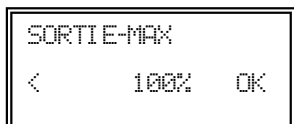

Appuyez sur "OK"

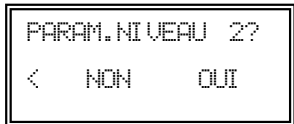
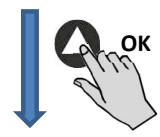

Appuyez sur "NO"

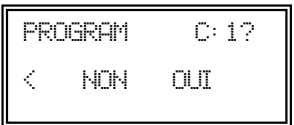
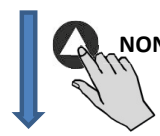

Appuyez sur "OUI" pour enregistrer les modifications

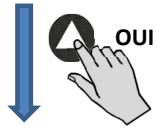

Appuyez sur n'importe quelle touche pour revenir à l'écran de départ

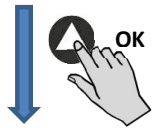

- Éteignez l'équipement grâce à l'interrupteur ARRÊT/MARCHE position "0".
- Revenez à la plaque interne et placez le micro-interrupteur SW2-2 sur "OFF".
- Le changement de numéro du ventilateur se fait lorsque vous rallumez l'appareil.

Une fois la console PROSYS ECOWATT connectée au MASTER, accéder aux autres unités identifiées avec le numéro attribué précédemment. À partir de l'écran d'accueil appuyer la touche  plusieurs fois pour accéder à l'écran du réglage des canaux de connexion. (Voir schéma ci-dessous)

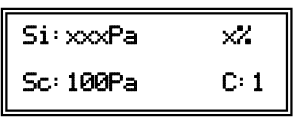

Écran principal

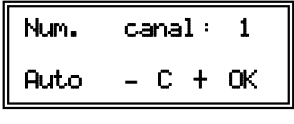
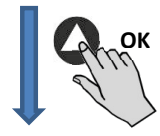

Écran du réglage des canaux de connexion

6.4. PARAMÈTRES GÉNÉRAUX

Une fois le branchement réalisé, alimentez le système au moyen de l'interrupteur arrêt/marche. Lorsque vous branchez l'appareil, l'écran suivant s'affiche :



Lorsque vous avez choisi la langue, un écran s'affiche avec les informations suivantes :

Si: xxxPa	x%
Sp: 100Pa	C: 1

Si: xxx Valeur mesurée (les unités dépendront du mode de fonctionnement)

Sp/Sc: xxx Consigne programmée

X% Vitesse ventilateur en % (par rapport à la vitesse maximale)

C: 1 Num. de ventilateur si connecté au réseau

Appuyez sur la touche pour accéder au second écran d'information :

RPM: xxx	InD: 0
Rele: 0	C: 1

RPM: xxx Nombre de tours ventilateur (les bornes TACOM doivent être connectées)

Rele: 0 Indique si la sortie de relais de l'alarme est connectée (0: sortie sans connexion; 1: sortie connectée)

InD: 0 Entrée numérique (J11 fonction nuit ou Min/Max) (0: sortie sans connexion; 1: sortie connectée)

C: 1 Canal de communication utilisé (de 1 à 247)

6.5. MISE EN MARCHÉ DU SYSTÈME

Après avoir fait le branchement et configuré, vous devez mettre le système sous tension.

Lorsque l'équipement est connecté, l'écran de départ affiche la version du logiciel, au bout de 3 secondes la connexion de l'équipement mémorisé commence. Si la connexion se fait avec succès, le premier écran d'information s'affiche. L'écran correspondant au contrôle PI PRESSION est celui qui s'affiche par défaut :

Contrôle PI PRESSION / COP	Contrôle PI DEBIT / CAV								
<table border="1"> <tr> <td>Si: 100 Pa</td> <td>100%</td> </tr> <tr> <td>Sp: 100 Pa</td> <td>C: 1</td> </tr> </table>	Si: 100 Pa	100%	Sp: 100 Pa	C: 1	<table border="1"> <tr> <td>Si: 100 m³/h</td> <td>100%</td> </tr> <tr> <td>Sp: 100 m³/h</td> <td>C: 1</td> </tr> </table>	Si: 100 m ³ /h	100%	Sp: 100 m ³ /h	C: 1
Si: 100 Pa	100%								
Sp: 100 Pa	C: 1								
Si: 100 m ³ /h	100%								
Sp: 100 m ³ /h	C: 1								
Contrôle PROPORTIONNEL / VAV	Contrôle MIN-MAX								
<table border="1"> <tr> <td>S2: 30%HR</td> <td>21%</td> </tr> <tr> <td>C: 1</td> <td></td> </tr> </table>	S2: 30%HR	21%	C: 1		<table border="1"> <tr> <td>IN_D: ON</td> <td>21%</td> </tr> <tr> <td>C: 1</td> <td></td> </tr> </table>	IN_D: ON	21%	C: 1	
S2: 30%HR	21%								
C: 1									
IN_D: ON	21%								
C: 1									

6.6. CONFIGURATION DES ÉQUIPEMENTS PAR LA CONSOLE

6.6.1. Changement de Consigne

Étapes à suivre pour modifier le point de consigne à partir de l'écran principal:

Si: XXX	x%
Sc: XXX	C:1

Si: xxx Valeur mesurée value (les unités dépendront du mode de fonctionnement)
Sc: xxx Consigne
X% Vitesse ventilateur en % (par rapport à la vitesse maximale)
C: 1 Num. ventilateur si connecté au réseau

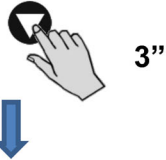

Appuyez pendant 3"

CONSIGNE CONSOLE:		
XXX	XXX	OK

Appuyez sur  ou  pour modifier manuellement le consigne

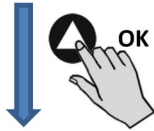

6.6.2. Changement de mode de fonctionnement

Lorsque le CAB-ECOWATT est sous tension, que la langue a été choisie et que la console affiche l'un des écrans de visualisation décrits ci-dessus, faites la séquence suivante:

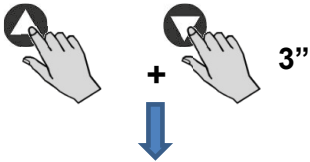

Appuyez simultanément pendant 3"

MOT DE PASSE :			
1	1	1	OK

Indiquez le mot de passe d'accès spécifique du canal. Par défaut : 1 1 1



MODIF. M.PASSE?	
NON	OUI

Il est possible d'affecter un nouveau mot de passe à l'équipement (canal)



MENU CONFIG		
CANAL N:	1	OK

Sélection du canal sur lequel vous souhaitez faire la configuration

Vous vous trouvez alors en mode configuration et vous pouvez vous déplacer dans les paramètres de l'équipement, en configurant le mode de travail:

PARAMETRES USINE
NON OUI

Appuyez sur « SI » pour recharger la configuration d'usine.

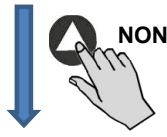

FONCTIONNEMENT
<PI PRESSION OK

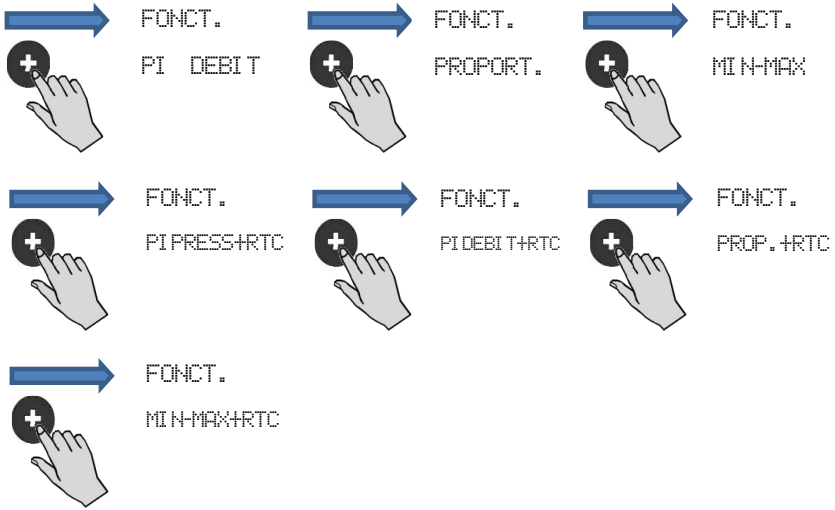
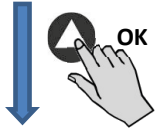

Fonctionnement: En fonction du mode sélectionné, les paramètres affichés seront les paramètres spécifiques à chaque mode. Modes terminés en RTC uniquement en combinaison avec l'accessoire programmeur horaire.

6.6.3. Fonctionnement mode PI PRESSION/COP

Le paragraphe 5 décrit que le ventilateur est prêt pour travailler en mode de pression constante en utilisant un capteur de pression intégré dans le boîtier de commande. Il est néanmoins possible de connecter un transducteur de pression externe (0-10V ou 4-20mA) qui devra être connecté aux bornes J5 ou J6.

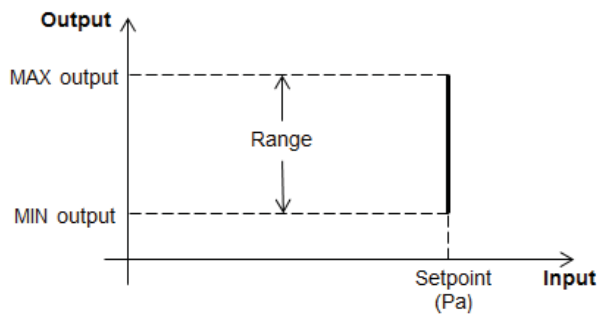

Fonctionnement mode PI PRESSION/COP

Après avoir sélectionné le mode de fonctionnement PI PRESSION, vous pourrez configurer les paramètres suivants:

SORTIE-MIN
< 20% OK

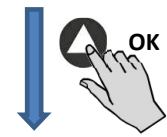

Appuyez sur **+** ou **-** pour modifier manuellement le paramètre de sortie minimum au moteur

SORTIE-MAX
< 100% OK

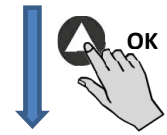

Appuyez sur **+** ou **-** pour modifier manuellement le paramètre de sortie maximum au moteur

PARAM.NIVEAU 2?
< NON OUI

Accès à la configuration de paramètres avancés

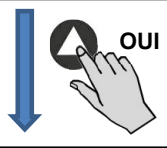

MOT DE PASSE :
1 1 1 OK

Indiquez le mot de passe d'accès spécifique du canal. Par défaut : 1 1 1

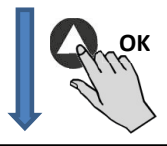

MODIF. M.PASSE?
NON OUI

Il est possible d'affecter un nouveau mot de passe à l'équipement (canal)

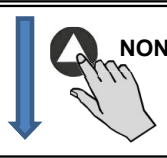

TYPE MOTEUR
< EC OK

Ne pas modifier

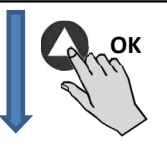

SONDE
< INTERNE OK

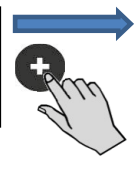

SONDE
<IN1 0-10V OK



SONDE
<IN1 4-20mA OK

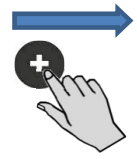

SONDE
<IN2 0-10V OK



SONDE
<IN2 4-20mA OK

Capteur: Type de capteur

- **INTERNE**: Sonde différentielle de pression interne
- **IN1 0-10V**: Sonde externe signal analogique 0-10V (borne J5)
- **IN1 4-20mA**: Sonde externe signal analogique 4-20mA (borne J5)
- **IN2 0-10V**: Sonde externe signal analogique 0-10V (borne J6)
- **IN2 4-20mA**: Sonde externe signal analogique 4-20mA (borne J6)

PLAGE
< 400Pa OK

Appuyez sur **+** ou **+** pour modifier manuellement le paramètre. La valeur qui s'affiche à l'écran correspond à l'échelle du capteur interne pré-réglé en usine. Si un capteur externe est installé, introduisez la plage d'échelle correspondante.

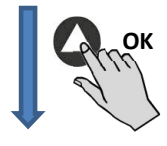

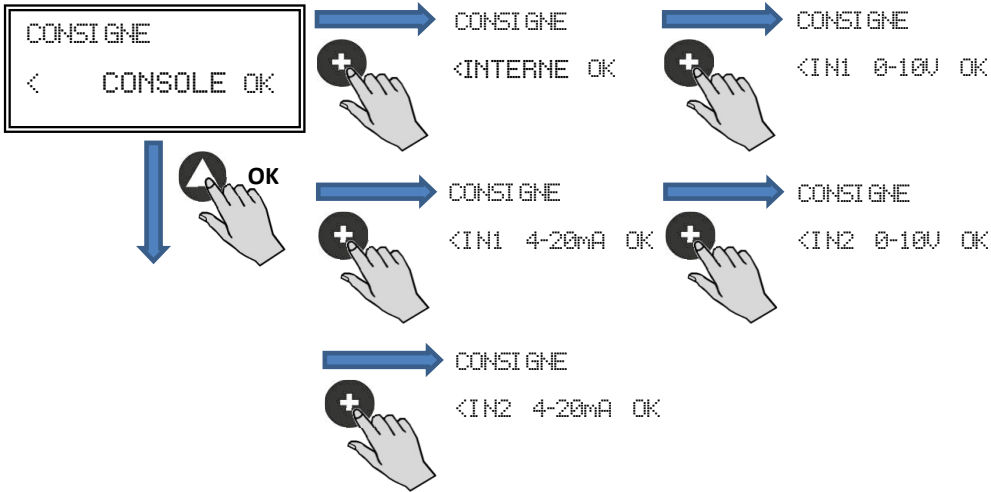

Consigne:

- INTERNE
- CONSOLE: Valeur réglée par console PROSYS ECOWATT. Valeur définie en usine
- IN1/IN2 0-10V: Valeur ajustée par le potentiomètre externe (0-10V)
- IN1/IN2 4-20mA: Valeur ajustée par le potentiomètre externe (4-20mA)



Appuyez sur ou pour modifier manuellement le paramètre. **Nous vous conseillons de ne pas le modifier.**

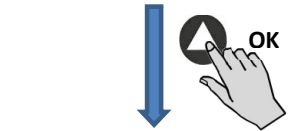

Appuyez sur ou pour modifier manuellement le paramètre. **Nous vous conseillons de ne pas le modifier.**

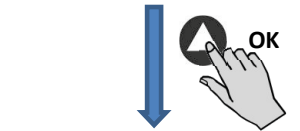

Appuyez sur ou pour modifier manuellement le paramètre. **Nous vous conseillons de ne pas le modifier.**

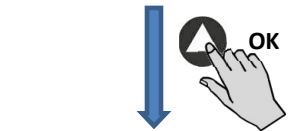

Appuyez sur ou pour modifier manuellement le paramètre. Cette valeur correspond au % sur la pression de consigne lorsque le ventilateur est en position nuit. Pour ce faire, vous pouvez connecter une horloge ou un interrupteur sans puissance dans l'entrée

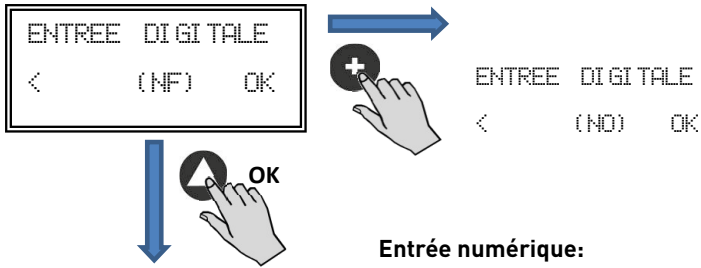

Entrée numérique:

- **NF:** Contact normalement fermé Le ventilateur passe en position nuit lorsque le contact est ouvert.
- **NO:** Contact normalement ouvert Le ventilateur passe en position nuit lorsque le contact se ferme.

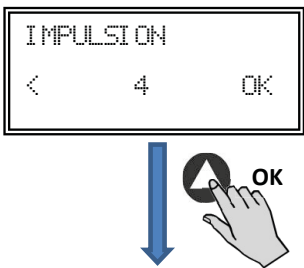

Appuyez sur **+** ou **+** pour modifier manuellement le paramètre qui permet d'afficher la vitesse du moteur par la sortie J8 (TACOM). **Il est conseillé de ne pas modifier la valeur par défaut.**

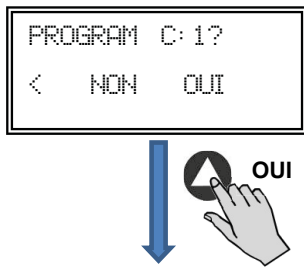

Enregistrer dans la mémoire les paramètres modifiés.

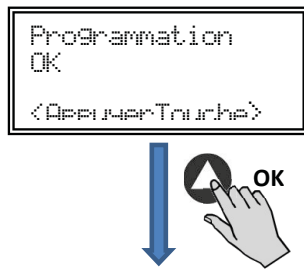

Appuyez sur n'importe quelle touche pour revenir à l'écran de départ.

6.6.4. Fonctionnement mode PI DÉBIT /CAV

Avant de sélectionner le mode de fonctionnement PI DEBIT par la console PROSYS ECOWATT, il est nécessaire de bien brancher les tubes de pression. Placez les tubes marqués "V" et "P-" comme indiqué ci-après (modèle CAB-125 ECOWATT n'est pas disponible en mode PI DÉBIT CONSTANT).

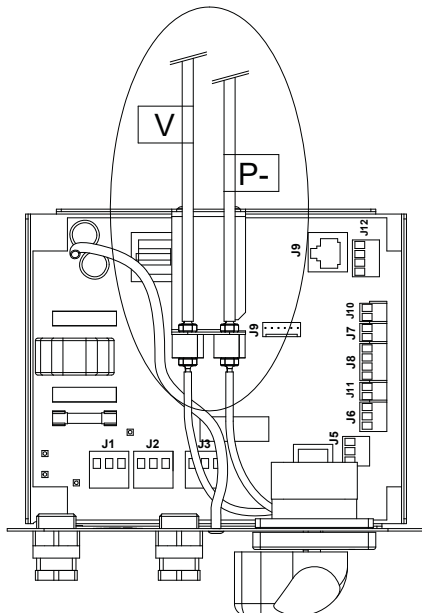

Caudal constante (aspiration)

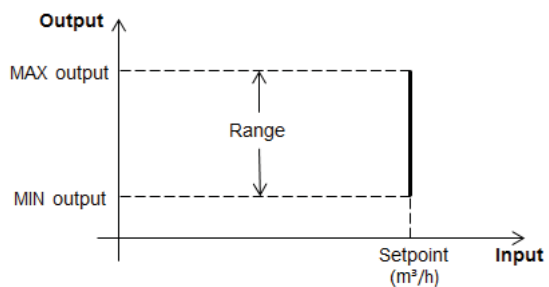



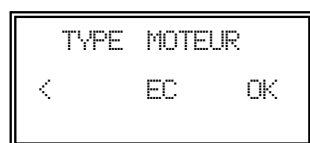
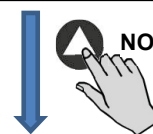
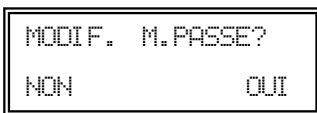
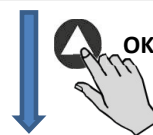
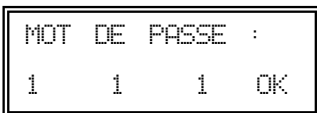
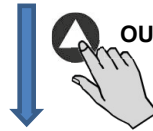
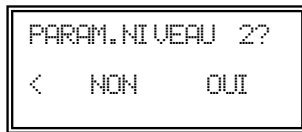
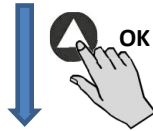
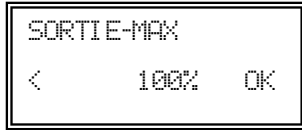

Caudal constante

Après avoir changé de mode de fonctionnement à PI DÉBIT, les paramètres suivants s'affichent:

FR



Appuyez sur  ou  pour modifier manuellement le paramètre de sortie minimum au moteur

Appuyez sur  ou  pour modifier manuellement le paramètre de sortie maximum au moteur

Accès à la configuration de paramètres avancés

Indiquez le mot de passe d'accès spécifique du canal. Par défaut : 1 1 1

Il est possible d'affecter un nouveau mot de passe à l'équipement (canal)

Ne pas modifier

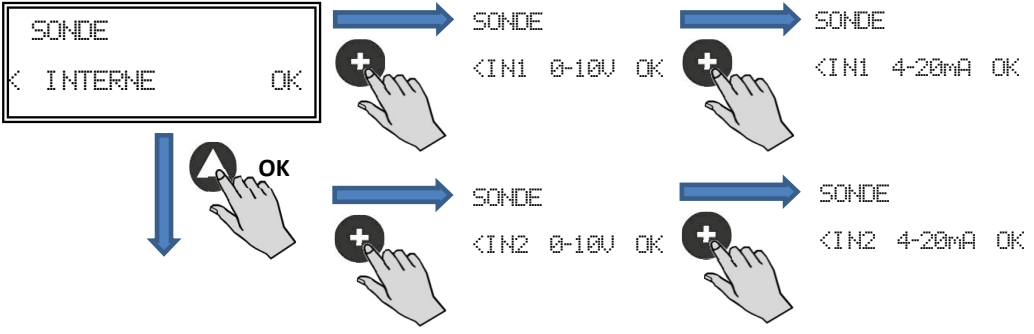

Capteur: Type de capteur

- **INTERNE:** Sonde différentielle de pression interne
- **IN1 0-10V:** Sonde externe signal analogique 0-10V (borne J5)
- **IN1 4-20mA:** Sonde externe signal analogique 4-20mA (borne J5)
- **IN2 0-10V:** Sonde externe signal analogique 0-10V (borne J6)
- **IN2 4-20mA:** Sonde externe signal analogique 4-20mA (borne J6)



Appuyez sur **+** ou **+** pour modifier manuellement le paramètre. La valeur qui s'affiche à l'écran correspond à l'échelle du capteur interne pré-réglé en usine. Si un capteur externe est installé, introduisez la plage d'échelle correspondante.

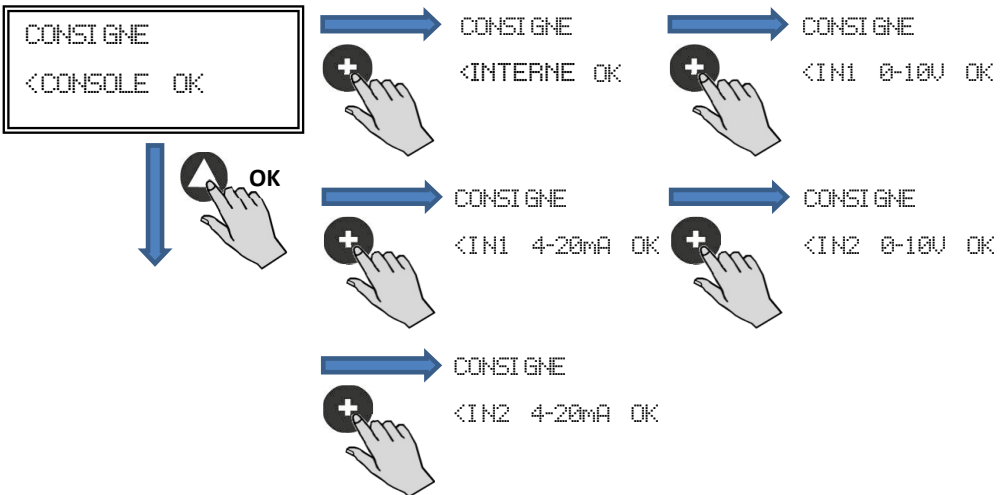

Consigne:

- **INTERNE**
- **CONSOLE:** Valeur réglée par console PROSYS ECOWATT. Valeur définie en usine
- **IN1/IN2 0-10V:** Valeur ajustée par le potentiomètre externe (0-10V)
- **IN1/IN2 4-20mA:** Valeur ajustée par le potentiomètre externe (4-20mA)



Appuyez sur **+** ou **+** pour modifier manuellement le paramètre. **Nous vous conseillons de ne pas le modifier.**

PARAMETRES
< Kp=100 OK



PARAMETRES
< Ki=20 OK



SONDE IN1
<SANS SOND E OK



SP-2 DEBIT
< 50% OK



ENTREE DIGITALE
< (NF) OK

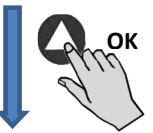

IMPULSION
< 4 OK

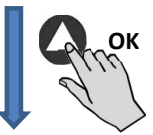

Appuyez sur ou pour modifier manuellement le paramètre. **Nous vous conseillons de ne pas le modifier.**

Appuyez sur ou pour modifier manuellement le paramètre. **Nous vous conseillons de ne pas le modifier.**

Appuyez sur ou pour modifier manuellement le paramètre. **Nous vous conseillons de ne pas le modifier.**

Appuyez sur ou pour modifier manuellement le paramètre. Cette valeur correspond au % sur la pression de consigne lorsque le ventilateur est en position nuit. Pour ce faire, vous pouvez connecter une horloge ou un interrupteur sans puissance dans l'entrée



ENTREE DIGITALE
< (NO) OK

Entrée numérique:

- **NF:** Contact normalement fermé Le ventilateur passe en position nuit lorsque le contact est ouvert.
- **NO:** Contact normalement ouvert Le ventilateur passe en position nuit lorsque le contact se ferme.

Appuyez sur ou pour modifier manuellement le paramètre qui permet d'afficher la vitesse du moteur par la sortie J8 (TACOM). **Il est conseillé de ne pas modifier la valeur par défaut.**

PROGRAMMER C: 1?
< NON OUI

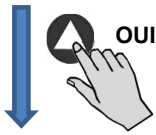

Enregistrer dans la mémoire les paramètres modifiés.

Programmation OK
<AppuyerTouche>

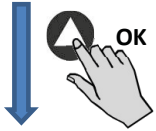

Appuyez sur n'importe quelle touche pour revenir à l'écran de départ

6.6.5. Fonctionnement mode PROPORTIONNEL / VAV

Dans cette modalité, le CAB-ECOWATT est conçu pour travailler avec une ou deux entrées analogiques. (4-20 mA ou 0-10V). Le boîtier de commande agit en fonction du paramètre de demande maximale. Les sondes sont connectées dans les entrées analogiques J5 et/ou J6.

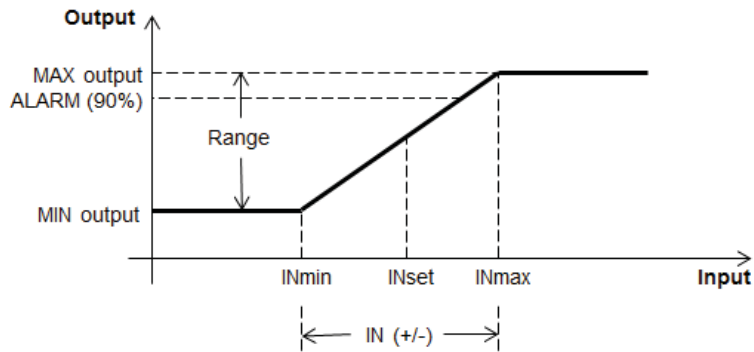

Fonctionnement mode PROPORTIONNEL / VAV

Après avoir changé de mode de fonctionnement PROPORTIONNEL, les paramètres suivants s'affichent:

SONDE IN1
<SANS SONDE OK

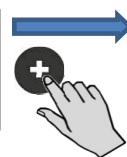

SONDE IN1
< 0-10V%HR OK



SONDE IN1
< 4-20mA%HR OK



SONDE IN1
< 0-10VTempOK



SONDE IN1
< 4-20mATempOK

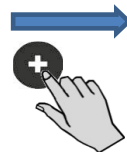

SONDE IN1
< 0-10VCO2 OK



SONDE IN1
< 4-20mACO2 OK

Capteur IN1:

- **SANS CAPTEUR:** Aucun capteur connecté à cette entrée
- **0-10V/4-20mA %HR:** Capteur humidité sortie analogique 0-10V/4-20mA
- **0-10V/4-20mA TEMP:** Capteur température sortie analogique 0-10V/4-20mA
- **0-10V/4-20mA CO2 :** Capteur CO2 sortie analogique 0-10V/4-20mA

INI PLAGE
< 100%HR OK



INI SET
< 50%HR OK



INI (+/-)
< 25%HR OK

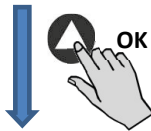

Appuyez sur **+** ou **+** pour modifier manuellement le fond d'échelle du capteur utilisé

Appuyez sur **+** ou **+** pour modifier manuellement la valeur moyenne de la plage d'utilisation

Appuyez sur **+** ou **+** pour modifier manuellement la valeur de largeur de la plage de réglage de la sonde

Procédez de même si vous avez sélectionné un autre type de capteur ou si vous avez activé la deuxième entrée analogique SONDE IN2.

SORTIE-MIN
< 20% OK

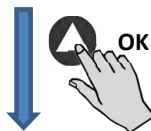

SORTIE-MAX
< 100% OK



PARAM.NIVEAU 2?
< NON OUI



Appuyez sur **+** ou **+** pour modifier manuellement le paramètre.

Appuyez sur **+** ou **+** pour modifier manuellement le paramètre.

Accès à la configuration de paramètres avancés

MOT DE PASSE :
1 1 1 OK

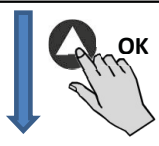

MODIF. M.PASSE?
NON OUI

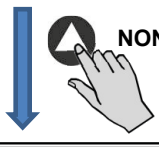

TYPE MOTEUR
< EC OK



S1-ALARME
< 90% OK

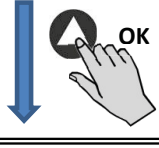

S2-ALARME
< 90% OK

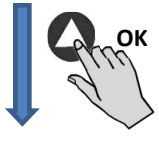

MIN RPM-ALARME
< 500 OK



IMPULSION
< 4 OK

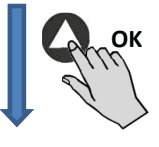

Indiquez le mot de passe d'accès spécifique du canal. Par défaut : 1 1 1 **Il est conseillé de ne pas modifier la valeur par défaut**

Il est possible d'affecter un nouveau mot de passe à l'équipement (canal)

Ne pas modifier

Appuyez sur ou pour modifier manuellement le paramètre. Cette valeur permet d'envoyer un message d'alarme lorsque la valeur mesurée par la sonde IN1 atteint un pourcentage de la valeur de plage de mesure.

Appuyez sur ou pour modifier manuellement le paramètre. Cette valeur permet d'envoyer un message d'alarme lorsque la valeur mesurée par la sonde IN2 atteint un pourcentage de la valeur de plage de mesure.

Appuyez sur ou pour modifier manuellement le paramètre. Permet d'envoyer un message d'alarme lorsque la valeur de régime du ventilateur arrive à une valeur minimale.

Appuyez sur ou pour modifier manuellement le paramètre. **Il est conseillé de ne pas modifier la valeur par défaut.**

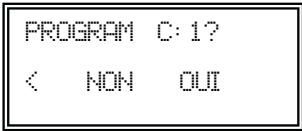

Validation paramètres modifiés

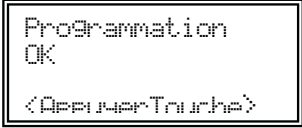
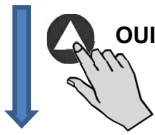

Validation basculement programmation

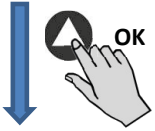

6.6.6. Fonctionnement mode MIN-MAX

Dans ce mode, le boîtier de commande est conçu pour travailler par contact, type normalement ouvert (NO) ou normalement fermé (NF) situés dans l'entrée numérique J11. Lorsque l'état de cette entrée change, le ventilateur passe à la vitesse minimale avec une valeur de réglage en % de la vitesse maximale.

Logique:

- NO (contact normalement ouvert) : Le ventilateur passe à la « vitesse minimale » lorsque le contact se ferme.
- NF (contact normalement fermé) : Le ventilateur passe à la « vitesse minimale » lorsque le contact s'ouvre.

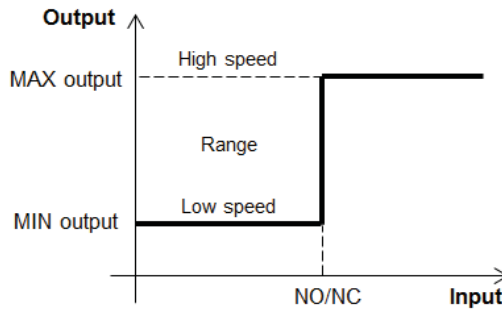

Fonctionnement mode MIN-MAX

Après avoir changé de mode de fonctionnement MIN-MAX, les paramètres suivants s'affichent:

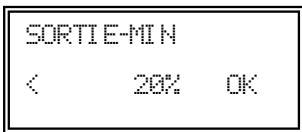

Appuyez sur ou pour modifier manuellement la valeur de sortie minimale.

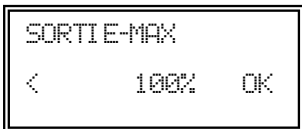
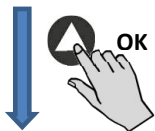

Appuyez sur ou pour modifier manuellement la valeur de sortie maximale.



PARAM. NIVEAU 2?
< NON OUI

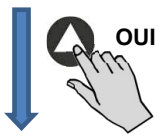

Accès à la configuration de paramètres avancés

MOT DE PASSE :
1 1 1 OK



Indiquez le mot de passe d'accès spécifique du canal. Par défaut : 1 1 1

MODIF. M. PASSE?
NON OUI

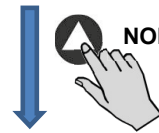

Il est possible d'affecter un nouveau mot de passe à l'équipement (canal)

TYPE MOTEUR
< EC OK

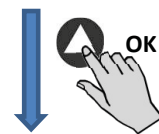

Ne pas modifier

ENTREE DIGITALE
< (NO) OK

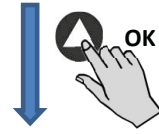

Entrée numérique:

- **NO:** Le ventilateur passe à la vitesse minimale lorsque le contact se ferme.
- **NF:** Le ventilateur passe à la vitesse minimale lorsque le contact s'ouvre.

IMPULSION
< 4 OK



Appuyez sur **+** ou **+** pour modifier manuellement le paramètre. **Il est conseillé de ne pas modifier la valeur par défaut.**

PROGRAM C: 1?
< NON OUI



Validation paramètres modifiés

Programmation OK
<Appuyer Touche>

Validation basculement programmation

7. FONCTIONNEMENT AVEC ACCESSOIRE DE PROGRAMMATION HORAIRE TIMER RTC ECOWATT AVEC L'ACCESSOIRE CONSOLE PROSYS ECOWATT

En achetant le programmeur horaire **TIMER RTC ECOWATT** offert comme accessoire, vous aurez accès aux fonctions décrites au paragraphe 6, *Fonctions Console PROSYS ECOWATT* et vous pourrez programmer les données suivantes:

- **Jusqu'à trois périodes quotidiennes à la consigne souhaitée.**
- **Période de vacances** par la programmation de la date et de l'heure de départ/de fin et % sur la vitesse maximale souhaitée.

7.1. INSTALLATION

Comme l'indique l'image ci-après, le programmeur horaire est un composant électronique qui devra être installé à l'intérieur du boîtier de commande.

Pour réussir cette opération correctement, procédez comme suit:

1. Déconnectez la tension par l'interrupteur frontal.
2. Accédez à l'intérieur du boîtier de commande
3. Localisez le connecteur J4

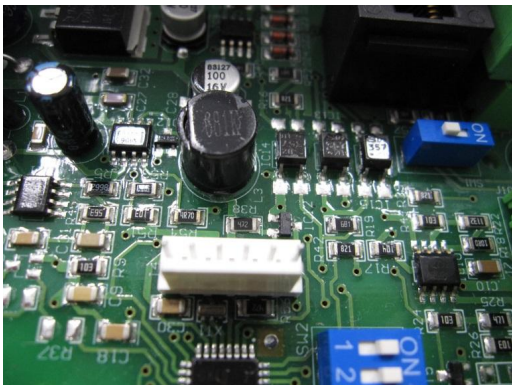

4. Alignez le composant électronique TIMER RTC ECOWATT avec les pattes du connecteur J4

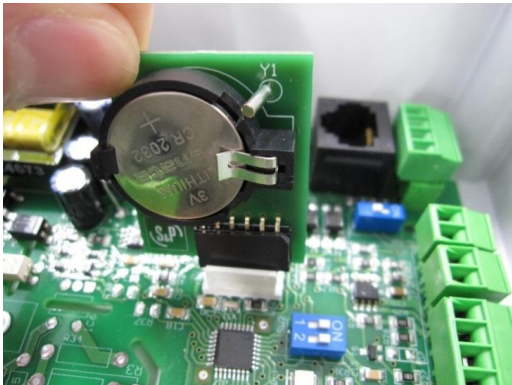

5. Encastrez le composant électronique en faisant pression vers le bas.



TIMER RTC ECOWATT

NOTE: Une fois installé, cliquez deux fois sur le bouton  sur la console PROSYS ECOWATT à ce date et de l'heure.

7.2. PROGRAMMATION

IMPORTANT: Avant de commencer à configurer le programmeur horaire il est important de sélectionner le mode approprié. Voir point 6.6.1. Changement mode fonctionnement de ce manuel et choisissez l'un des modes suivants: *PI PRESSION+RTC*, *PI DEBIT+RTC*, *PROPORTIONNEL+RTC* o *MAX-MIN+RTC*.

Pendant la programmation définissez les paramètres suivants:

- **T1, T2, T3:** Heure de début de chaque temporisation (OFF,00:00-23:59)
- **Temps T1, Temps T2, Temps T3:** La durée en minute de chaque temporisation en rapport avec son heure de début (jusqu'à 480 minutes)
- **Consigne T1, Consigne T2, Consigne T3:** La consigne en pourcentage souhaitée pendant la temporisation sur le mode de fonctionnement sélectionné au préalable *(exemple: si un mode PI PRES+RTC est sélectionné et une consigne T1 de 50% est définie pendant la temporisation, le ventilateur réduira la valeur de pression de référence SC de 50%)*.

Le tableau suivant servira d'exemple:

	LUNDI	MARDI	...	SAMEDI	DIMANCHE
1:00	T3 = 480 min ConsigneT3 = 25%	T3 = 480 min ConsigneT3 = 25%	...	T3 = 480 min ConsigneT3 = 25%	T3 = 480 min ConsigneT3 = 25%
2:00					
3:00					
4:00					
5:00					
6:00					
7:00					
8:00				T1 = 60min ConsigneT1 = 50%	T1 = 60min ConsigneT1 = 50%
9:00				T2 = 120 min ConsigneT1 = 50%	T2 = 120 min ConsigneT1 = 50%
10:00	T1 = 60min ConsigneT1 = 50%	T1 = 60min ConsigneT1 = 50%			
11:00					
12:00					
13:00					
14:00	T2 = 120 min ConsigneT1 = 50%	T2 = 120 min ConsigneT1 = 50%			
15:00					
16:00					
22:00					
23:00	T3 = 480 min ConsigneT3 = 25%	T3 = 480 min ConsigneT3 = 25%		T3 = 480 min ConsigneT3 = 25%	T3 = 480 min ConsigneT3 = 25%
0:00					

Pour commencer à programmer, procédez comme suit:

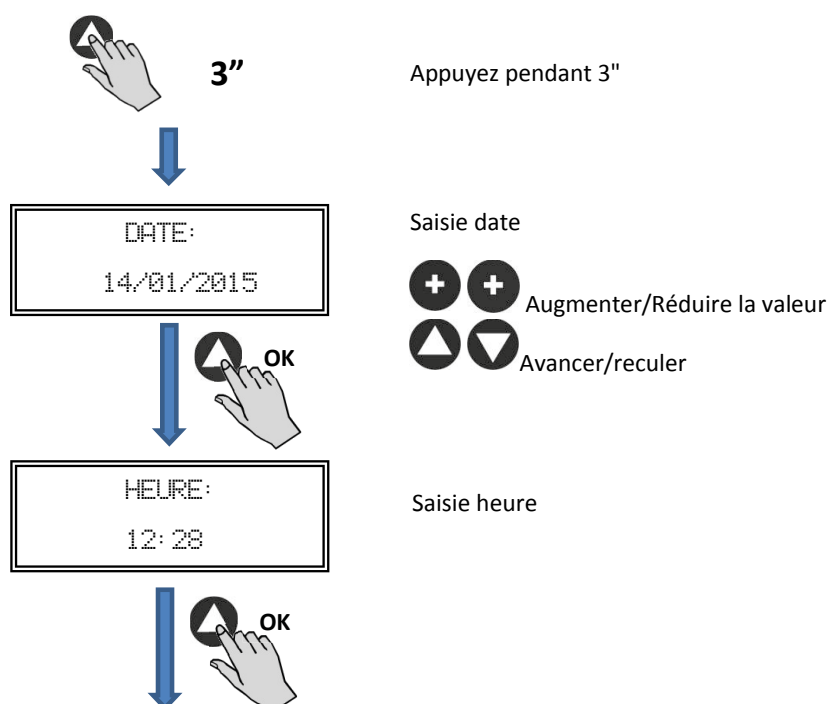

SORTIR?
CONT OUI

Appuyez sur **SI** pour revenir à l'écran initial



LUNDI
T1 09:00

Saisie de l'heure de début temporisation T1 pour le lundi



LUNDI
T2 11:00

Saisie de l'heure de début temporisation T2 pour le lundi



LUNDI
T3 14:00

Saisie de l'heure de début temporisation T3 pour le lundi



MARDI
NON MEME? OUI

Acceptez pour copier la programmation du lundi



TEMPS T1
5 m

Saisie durée temporisation T1 (0-480 min)

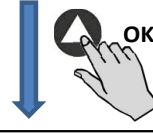

TEMPS T2
15 m

Saisie durée temporisation T2 (0-480 min)

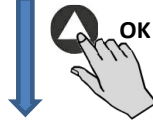

CONSIGNE T1
80

Saisie pourcentage sur la consigne du mode de fonctionnement sélectionné (OFF,0-100%)

Suivre séquence

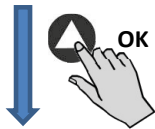

DATE DEPART
19/12/2014

Saisie date début période vacances

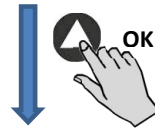

HEURE DEPART
14:58

Saisie date début période vacances

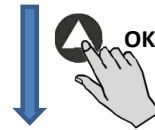

DATE FIN
30/12/2014

Saisie date fin période vacances

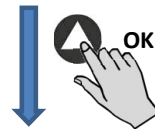

HEURE FIN
20:00

Saisie heure fin période vacances

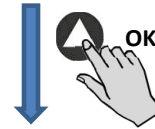

CONSIGNE VAC
20%

Saisie pourcentage sur consigne période vacances



SORTIR?
NON OUI

Confirmer configuration



Programmation OK
<Appuyer Touche>

Validation basculement programmation



7.3. TABLEAU RÉSUMÉ VALEURS DE RÉGLAGE

Registre	Min.	Max.	Commentaires
T1 T2 T3	OFF	23:59	Heure début temporisation
Temps T1 Temps T2 Temps T3	0min	480min	Durée minutes temporisation
Consigne T1 Consigne T2 Consigne T3	OFF	100%	Pourcentage sur la consigne
Date départ	00:00	23:59	Date début période vacances
Heure départ	00:00	23:59	Heure début période vacances
Date fin	00:00	23:59	Date fin période vacances
Heure fin	00:00	23:59	Heure fin période vacances
Consigne VAC	OFF	100%	Consigne période vacances

8. INTÉGRATION DANS LE SYSTÈME DE COMMUNICATION MODBUS

8.1. CARACTÉRISTIQUES DE BASE DU CONTRÔLE MODBUS-RTU

Direction	Esclave: adresse configurable de 1 à 247	Maître: doit pouvoir s'adresser aux esclaves avec l'adresse de 1 à 247
Diffusion	Si	
Vitesse de transmission	9600 (19200 est également recommandé)	
Parité	PAR/EVEN	
Mode	RTU	
Interface électrique	RS485 2W-câblage ou RS232	
Type connecter	RJ 45	

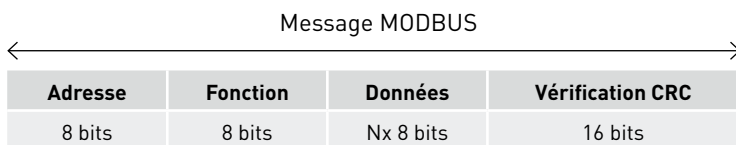

Le format pour chaque byte en mode RTU est:

- Système de codes: 8-bit binaire
- Bits par Byte: 1 bit de START (démarrage)
8 bits de données, le bit le plus significatif est envoyé en premier
1 bit pour la parité (parité paire nécessaire)
1 bit de STOP (arrêt)

8.2. PLAN DE MÉMOIRE MODBUS

Holding registers

N°REG.	Registre	Min.	Max.	Description	Par défaut	Commentaires
0	TypeMoteur	0	1	0=CA 1=CC	1	Type moteur
1	ModeFun	0	7	0=PI_Pression 1=PI_Débit 2=Proportionnel 3=Max-Min 4=PI_Pression+RTC 5=PI_Débit+RTC 6=Proportionnel+RTC 7=Max-Min+RTC	0	Mode de fonctionnement
2	Capteur PI	0	4	0=Interne 1=IN1 0-10V 2=IN1 4-20mA 3=IN2 0-10V 4=IN2 4-20mA	0	Types de capteurs pour mode PI_Pression ou PI_Débit
3	Capteur 1	0	7	0=NO 1=0-10V %HR 2=4-20mA %HR 3=0-10V °C 4=4-20mA °C 5=0-10V CO2 6=4-20mA CO2 7=NTC 100K	0	Type de capteur mode Proportionnel pour entrée analogique 1
4	Capteur 2	0	6	0=NO 1=0-10V %HR 2=4-20mA %HR 3=0-10V °C 4=4-20mA °C 5=0-10V CO2 6=4-20mA CO2	0	Type de capteur mode Proportionnel pour entrée analogique 2
5	PIPlage	50 50 100	1250 2500 9900	Capteur PI=0 CapteurPI<>0 Capteur<>0	400 (CAB-125/150/160 ECOWATT) 500 (CAB-200/315 ECOWATT) 650 (CAB-250 ECOWATT) 550 (CAB-355/400 ECOWATT)	Fond échelle mode PI
6	Point de réglage	0	5	0=Interne 1=IN1 0-10V 2=IN1 4-20mA 3=IN2 0-10V 4=IN2 4-20mA 5=Console MODBUS (PROSYS ECOWATT)	5	Consigne mode PI
7	Kp	1	250	Incréments 1	20	Constante Proportionnelle modePI
8	Ki	1	250	Incréments 1	20	Constante Intégrale modePI
9	Kq	50	300	Incréments 1	50 (CAB-125 ECOWATT) 56 (CAB-150/160 ECOWATT) 81 (CAB-200 ECOWATT) 88 (CAB-250 ECOWATT) 108 (CAB-315 ECOWATT) 136 (CAB-355 ECOWATT) 81 (CAB-400 ECOWATT)	Constante Débit avec capteur de pression
10	PusionsEncodeur	0	16	Incréments 1	2 5 1	Numéros impulsions par retour de l'encodeur
11	MinOut	0	50	Incréments 5%	25	Valeur sortie minimale
12	MaxOut	50	100	Incréments 5%	100	Valeur sortie maximale

N°REG.	Registre	Min.	Max.	Description	Par défaut	Commentaires
13	S1Alarme	0	100	Incréments 5%	90	Alarme entrée analogique 1
14	S2Alarme	0	100	Incréments 5%	90	Alarme entrée analogique 1
15	MiniRPM	100	500	Incréments 100	300	Min RPM d'alarme
16	VacMIN	80	150	Incréments 10	80	Tension minimale Moteur CA
17	IN1 Plage	0 0 0	100 50 2000	%HR incréments *C incréments PPM incréments	100	Fond échelle mode Proportionnel entrée 1
18	IN2 Plage	0 0 0	100 50 2000	%HR incréments *C incréments PPM incréments	2000	Fond échelle mode Proportionnel entrée 2
19	IN1 Set	0	IN1 Plage	Incréments 1	70	Consigne mode Proportionnel entrée 1
20	IN1 Bande	0	IN1 Plage	Incréments 1	40	Marge (+/-) centré sur IN1 Set
21	IN2 Set	0	IN2 Plage	Incréments 1	1000	Consigne mode Proportionnel entrée 2
22	IN2 Bande	0	IN2 Plage	Incréments 1	1000	Marge (+/-) centré sur IN2 Set
23	InD	0	1	0=NO 1=NF	0	Inversion Entrée Numérique
24	setMODUS	1	PIPlage	Incréments 50	100 (CAB-125 ECOWATT) 150 (CAB-150/160/200/ 150/315 ECOWATT) 200 (CAB-355/400 ECOWATT)	Consigne MODBUS
25	LANGUE	0	3	0=ANGLAIS 1=ESPAGNOL 2=FRANÇAIS 3=ALLEMAND	0	Langue
26	SP-2 PRESSION	25	100	Incréments 1	25	Consigne nuit mode PL Pression
27	SP-2 DÉBIT	50	100	Incréments 1	50	Consigne nuit mode PL Débit
28	SP Temp	-10	50	Incréments 1		Consigne Température (uniquement pour modèle CTBH ECOWATT)
29	adMODBUS	1 0	247 100	Incréments 1	1	
30	ALARME	0	1			
31	DATE	0x0000	0xfe7f	Jour/Mois/Année	0x088E	Date actuelle
32	HEURE	0x0000	0x3dfb	Heure / Minute	0x0000	Heure actuelle
33	LUNDI T1	0x0000	0x063b	Heure / Minute	0x0200	Début temporisation 1 lundi
34	LUNDI T2	0x0000	0x063b	Heure / Minute	0x0300	Début temporisation 2 lundi
35	LUNDI T3	0x0000	0x063b	Heure / Minute	0x0480	Début temporisation 3 lundi
36	MARDI T1	0x0000	0x063b	Heure / Minute	0x0200	Début temporisation 1 mardi
37	MARDI T2	0x0000	0x063b	Heure / Minute	0x0300	Début temporisation 2 mardi
38	MARDI T3	0x0000	0x063b	Heure / Minute	0x0480	Début temporisation 3 mardi
39	MERCREDI T1	0x0000	0x063b	Heure / Minute	0x0200	Début temporisation 1 mercredi
40	MERCREDI T2	0x0000	0x063b	Heure / Minute	0x0300	Début temporisation 2 mercredi
41	MERCREDI T3	0x0000	0x063b	Heure / Minute	0x0480	Début temporisation 3 mercredi
42	JEUDI T1	0x0000	0x063b	Heure / Minute	0x0200	Début temporisation 1 jeudi
43	JEUDI T2	0x0000	0x063b	Heure / Minute	0x0300	Début temporisation 2 jeudi
44	JEUDI T3	0x0000	0x063b	Heure / Minute	0x0480	Début temporisation 3 jeudi

N°REG.	Registre	Min.	Max.	Description	Par défaut	Commentaires
45	VENDREDI T1	0x0000	0x063b	Heure / Minute	0x0200	Début temporisation 1 vendredi
46	VENDREDI T2	0x0000	0x063b	Heure / Minute	0x0300	Début temporisation 2 vendredi
47	VENDREDI T3	0x0000	0x063b	Heure / Minute	0x0480	Début temporisation 3 vendredi
48	SAMEDI T1	0x0000	0x063b	Heure / Minute	0x0200	Début temporisation 1 samedi
49	SAMEDI T2	0x0000	0x063b	Heure / Minute	0x0300	Début temporisation 2 samedi
50	SAMEDI T3	0x0000	0x063b	Heure / Minute	0x0480	Début temporisation 3 samedi
51	DIMANCHE T1	0x0000	0x063b	Heure / Minute	0x0200	Début temporisation 1 dimanche
52	DIMANCHE T2	0x0000	0x063b	Heure / Minute	0x0300	Début temporisation 2 dimanche
53	DIMANCHE T3	0x0000	0x063b	Heure / Minute	0x0480	Début temporisation 3 dimanche
54	TEMPS T1	0	480	1	60	Durée minutes temporisation 1
55	TEMPS T2	0	480	1	60	Durée minutes temporisation 2
56	TEMPS T3	0	480	1	60	Durée minutes temporisation 3
57	CONSIGNE T1	0	100	1	80	Pourcentage sur la consigne
58	CONSIGNE T2	0	100	1	60	Pourcentage sur la consigne
59	CONSIGNE T3	0	100	1	100	Pourcentage sur la consigne
60	DATE DÉBUT	0	0xfe7f	Jour/Mois/Année	0x088E	Date début période vacances
61	HEURE DÉBUT	0x0000	0x063b	Heure / Minute	0	Heure début période vacances
62	DATE FIN	0	0xfe7f	Jour/Mois/Année	0x088E	Date fin période vacances
63	HEURE FIN	0x0000	0x063b	Heure / Minute	0	Heure fin période vacances
64	Consigne VAC	0	100	1	20	Consigne période vacances
65	VERSION	0	250	1		Consultation seulement
66	BaudRate	0	3	0=19200 1=9600 2=4800 3=2400	1	Velocidad de transmisión
67	Parité	0	2	0=No 1=Even 2=Odd	1	Parité réseau MODBUS

Input registers (lecture uniquement)

N°REG.	Registre	Min.	Max.	Description	Par défaut	Commentaires
0	Pote	0	255	Potentiomètre RV1 PCB		Potentiomètre RV1
1	In1	0	255	Entrée analogique 1		Entrée analogique 2
2	In2	0	255	Entrée analogique 2		Entrée analogique 2
3	Interne	0	1250	Capteur pression int.		Capteur pression interne
4	Régime	0	6000	Rpm moteur		Vitesse du moteur (si rpm<100, rpm=0)

Discrete inputs (lecture uniquement)

N°REG.	Registre	Min.	Max.	Description	Par défaut	Commentaires
0	InD	0	1	Entrée numérique		Entrée numérique

Output coils (lecture uniquement)

N°REG.	Registre	Min.	Max.	Description	Par défaut	Commentaires
0	Output	0	1	Relais		Relais

9. MAINTENANCE

Avant de manipuler le ventilateur, vérifiez qu'il est bien déconnecté du réseau même s'il est déjà arrêté et que personne ne peut le remettre en marche pendant l'intervention.

Il est nécessaire d'inspecter régulièrement l'appareil. La fréquence des contrôles doit être définie en fonction des conditions de travail pour éviter l'accumulation de saleté dans les hélices, les roues, les moteurs et les grilles qui pourraient représenter un risque et réduirait sensiblement la durée de vie de l'appareil.

Dans les opérations de nettoyage faites attention à ne pas déséquilibrer l'hélice ou la roue.

Dans tous les travaux de maintenance et réparation veuillez observer les règles de sécurité en vigueur dans chaque pays.

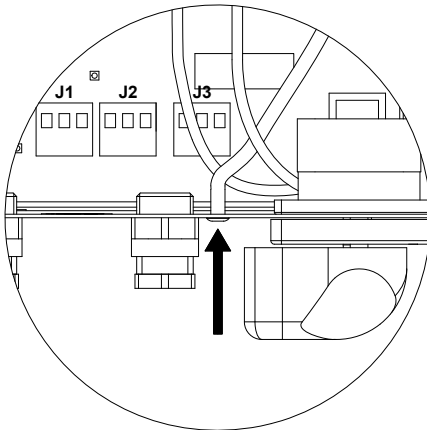

Vérifier la propreté du trou du tube de pression ambiante. L'accumulation de saleté faussera la lecture et provoquera un fonctionnement anormal.

10. MISE HORS SERVICE ET RECYCLAGE



La norme de la CEE et l'engagement que nous devons maintenir envers les futures générations nous obligent à recycler le matériel; nous vous prions de ne pas oublier de déposer tous les éléments restants de l'emballage dans les containers correspondants de recyclage. Si ce symbole est apposé sur l'appareil, déposer l'appareil remplacé dans la déchetterie la plus proche.

INHOUD

1. INLEIDING	100
2. VEILIGHEIDSVOORSCHRIFTEN EN "CE"-MARKERING	100
3. ALGEMENE INSTRUCTIES	100
4. BESCHRIJVING	101
4.1. Plaats van onderdelen	101
4.2. Bedradingschema en interne printplaat	102
5. BEDIENING ZONDER PROSYS ECOWATT-CONSOLE	103
6. BEDIENING MET PROSYS ECOWATT-CONSOLE (ACCESSOIRE)	103
6.1. Beschrijving	104
6.2. Gebruik van de console	104
6.3. Installatie	105
6.4. Algemene parameters	108
6.5. Opstarten van het systeem	108
6.6. Configuratie unit via console	109
6.6.1. Wijzig het instelpunt	109
6.6.2. Bedrijfsmodus wijzigen	109
6.6.3. Bediening PI_DRUK/COP-modus	110
6.6.4. Bediening CAV/PI_VOLUME-modus	113
6.6.5. Bediening PROPORTIONEEL/VAV-modus	117
6.6.6. Bedrijfsmodus MIN/MAX	120
7. BEDIENING MET OPTIONELE PROGRAMMATIMER RTC ECOWATT EN PROSYS ECOWATT-CONSOLE (ACCESSOIRES)	121
7.1. Installatie	122
7.2. Programmeren	123
7.3. Samenvatting tabel instelwaarden	126
8. INTEGRATIE MODBUS-COMMUNICATIESYSTEEM	126
8.1. Basisfuncties van de Modbus-RTU aansturing	126
8.2. Geheugenkaart Modbus	127
9. ONDERHOUD	130
10. RECYCLING	130

1. INLEIDING

Hartelijk dank voor de aankoop van dit product. Dit product is gemaakt volgens alle van toepassing zijnde veiligheidsvoorschriften en **EU**-normen. Lees deze handleiding zorgvuldig door. Hierin staat informatie die belangrijk is voor uw veiligheid tijdens de installatie, het gebruik en het onderhoud van dit product.

Bewaar deze handleiding voor later gebruik.

Controleer dat het product bij het uitpakken in perfecte staat is, omdat alle fabricagefouten onder de garantie van **S&P** vallen.

2. VEILIGHEIDSVOORSCHRIFTEN EN "CE"-MARKERING

De technici van **S&P** werken hard aan de ontwikkeling van steeds efficiëntere producten die voldoen aan de laatste veiligheidsvoorschriften.

Onderstaande instructies en aanbevelingen zijn een afspiegeling van de huidige voorschriften, met name voorschriften ten aanzien van veiligheid, en zijn daarom gebaseerd op naleving van algemene voorschriften. Mensen die blootgesteld worden aan risico's dienen daarom bij voorkeur de veiligheidsvoorschriften na te leven die binnen uw land van toepassing zijn. **S&P** kan niet aansprakelijk gesteld worden voor mogelijke schade of letsel als gevolg van het niet naleven van de veiligheidsvoorschriften of wijzigingen aan het product.

De CE-markering en de desbetreffende conformiteitsverklaring vormen een bewijs van de conformiteit van het product met de huidige **EU**-voorschriften.

3. ALGEMENE INSTRUCTIES

Voor dit product is een risico-analyse uitgevoerd, zoals voorzien in de machinerichtlijn. De handleiding bevat informatie voor alle werknemers die aan deze risico's worden blootgesteld, ter voorkoming van mogelijke schade of letsel als gevolg van foutief gebruik of onderhoud.

Alle onderhoudsactiviteiten (regulier of niet-regulier) moeten uitgevoerd worden met uitgeschakelde machine, terwijl de elektrische voedingsspanning is losgekoppeld.

Voordat de voedingskabel wordt aangesloten op de klemmenkast moet u controleren dat de netspanning overeenkomt met de spanning zoals aangegeven op het typeplaatje van de unit.

De voedingskabel moet tweemaal door de ferrietkern WE74271221 geleid worden, met een lus. De ferrietkern wordt meegeleverd in de verpakking.



4. BESCHRIJVING

4.1. PLAATS VAN ONDERDELEN

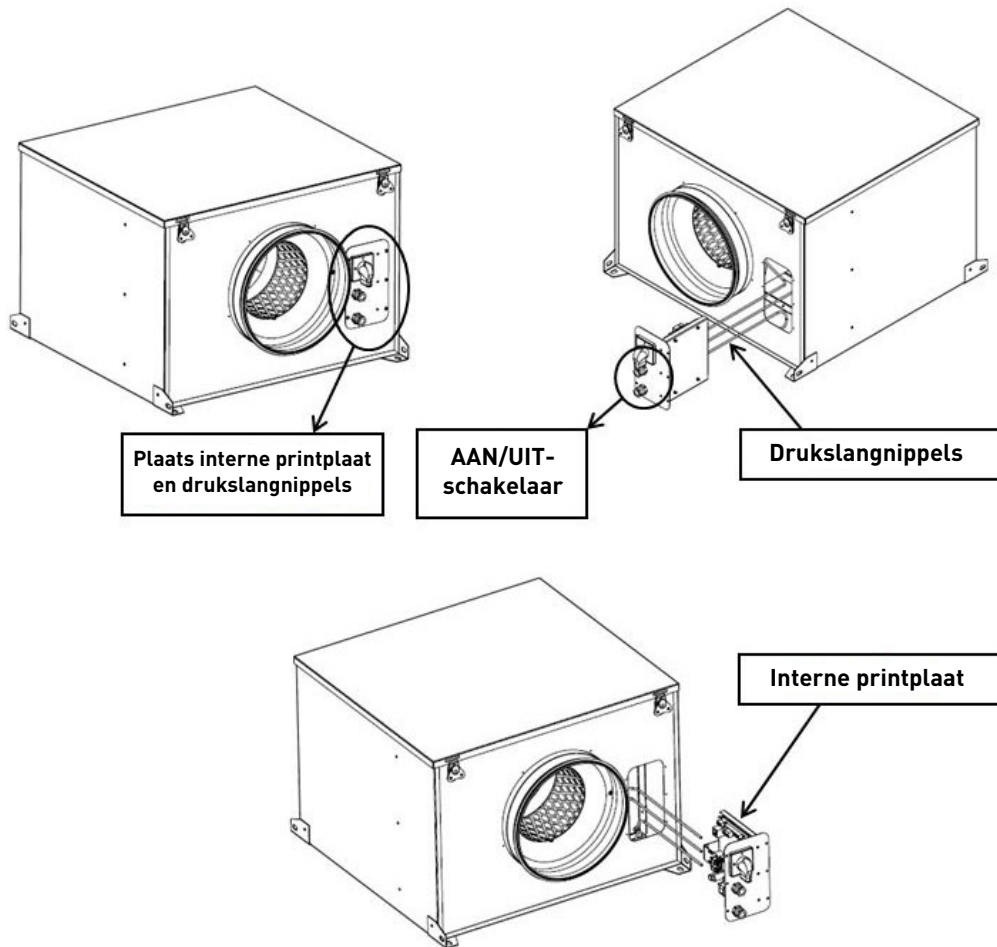

BELANGRIJK:

In de ruimte waar de interne printplaat zit, bevinden zich drie slangetjes die gemarkeerd zijn met "V", "P-" en "P+" en die vanuit de binnenzijde van de boxventilator steken. Als de ventilator geleverd wordt voor constante druk (COP) wordt buis "P" aangesloten. De plaatsing van de slangetjes niet veranderen voordat u hoofdstuk 6.6.3 heeft doorgelezen.

4.2. BEDRADINGSSCHEMA EN INTERNE PRINTPLAAT

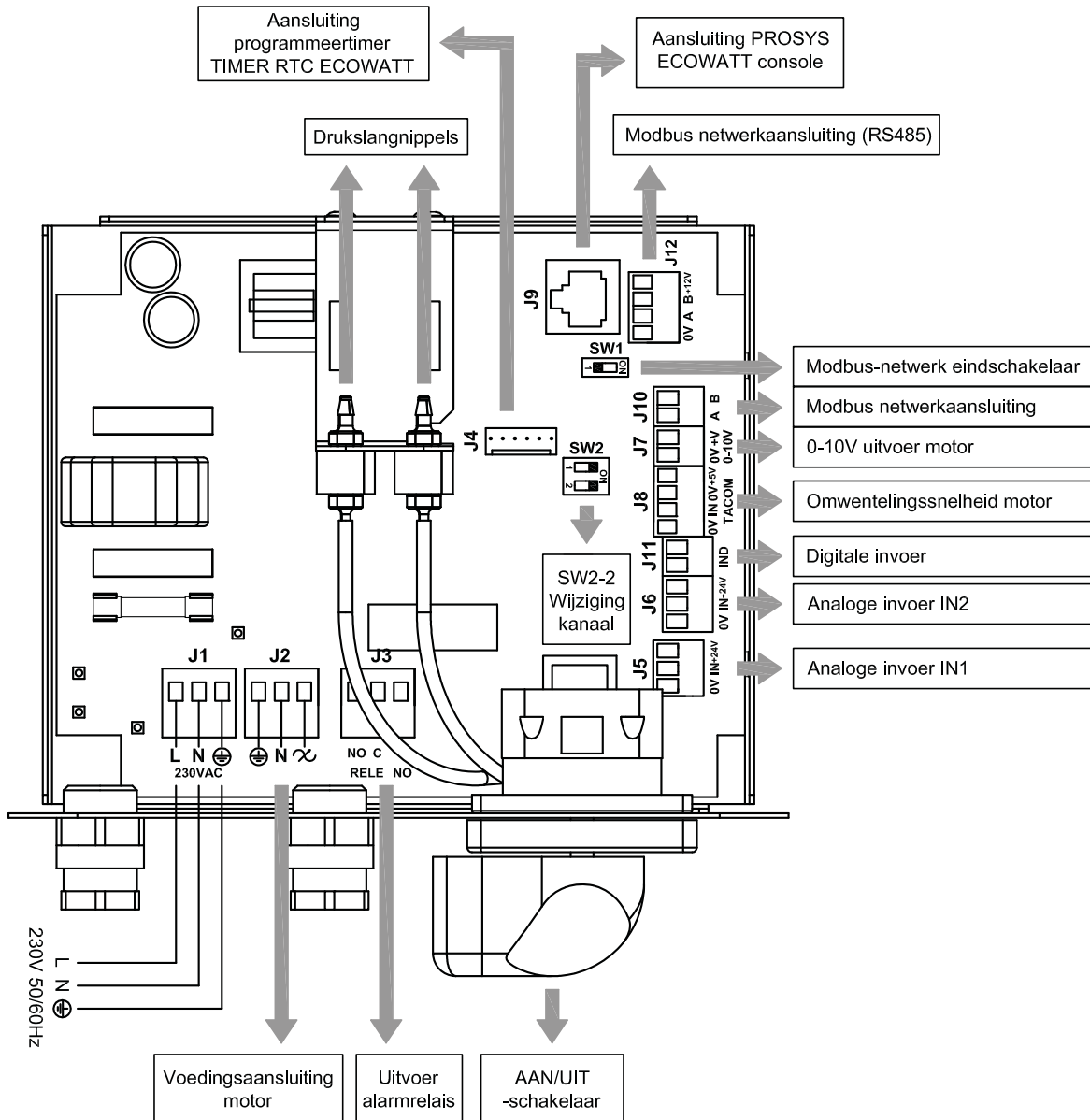

Ingangsaansluitingen	Beschrijving
L, N, GND (J1)	Voeding. 220-230 V AC 50 Hz
Druklangaansluiting 1	Aansluitnippel voor drukslang, afhankelijk van bedrijfsmodus
Druklangaansluiting 2	
Stekker (J4)	Ingang voor aansluiting programmatimer RTC ECOWATT (accessoire)
0V, IN, +24V (J5)	Analoge ingang IN1 4-20 mA of 0-10V
0V, IN, +24V (J6)	Analoge ingang IN2 4-20 mA of 0-10V
RJ45 (J9)	Aansluiting PROSYS ECOWATT-console (accessoire)
IND (J11)	Digitale ingang voor nachtprogramma of bedrijfsmodus MIN/MAX In geopende stand werkt de ventilator op nachtsnelheid, of op minimale snelheid als het relais gesloten is. In gesloten stand werkt de ventilator op nachtsnelheid, of op minimale snelheid als het relais geopend is.

Uitgangsaansluitingen	Beschrijving
GND, N, ∞ (J2)	Doorvoer voeding interne printplaat via AAN/UIT-schakelaar (standaardbedrading vanuit fabriek)
RELAIS (J3)	Schakelt als een alarm geactiveerd wordt (maximale belasting 2A)
0V, +V (J7)	Uitgang analoog signaal 0-10V naar de motor
TACOM (J8)	Draaisnelheid motor
A, B (J10)	Netwerkaansluiting. Modbus protocol
RS485 (J12)	Netwerkaansluiting. Modbus protocol

Microschakelaars	Beschrijving
SW1	Afsluitweerstand. Uitsluitend voor gebruik in Modbus-communicatienetwerk.
SW2	SW2-2: wijziging kanaal inschakelen

5. BEDIENING ZONDER PROSYS ECOWATT-CONSOLE

De akoestische geïsoleerde boxventilator CAB ECOWATT PLUS is voorbereid voor bedrijf onder constante druk (COP/PI DRUK) door middel van aflezing van het drukverschil tussen de aanzuigzijde en een vooraf, in de fabriek ingestelde drukwaarde.

NL

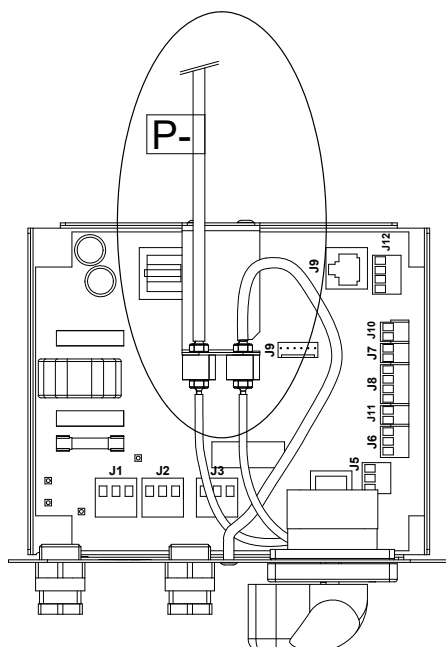

Constante druk (aanzuiging) standaardinstelling

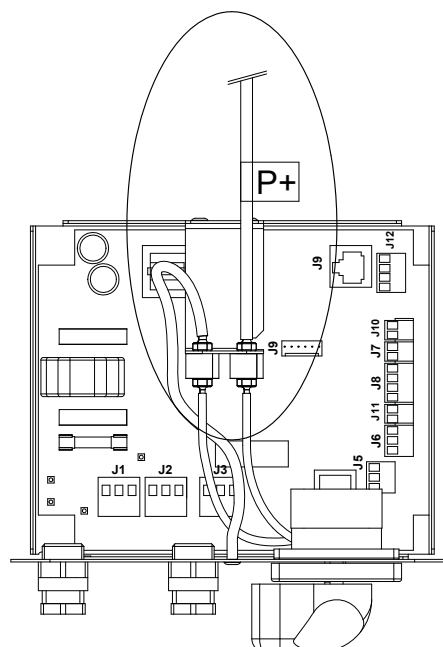

Constante druk (uittredende lucht)

Tabel instelling drukwaarde

Model	Instelpunt (Pa)
125	100
150	150
160	150
200	150
250	150
315	150
355	200
400	200

Het apparaat is vanuit de fabriek ingesteld op een constante druk aan de aanzuigzijde. Het is echter ook mogelijk deze druk aan de uittredende kant te realiseren.

6. BEDIENING MET PROSYS ECOWATT-CONSOLE (ACCESSOIRE)

Als u als accessoire de PROSYS ECOWATT-console aanschaft kan de boxventilator op de volgende manier gebruikt worden:

- **Systeem met constante druk (PI DRUK/COP)** met instelbare puntparameters.
- **Systeem met constant luchtdebiet (PI VOLUME/COP)** met instelbare puntparameters.
- **Systeem met variabel luchtdebiet (PROPORTIONEEL/VAV)** (hiervoor is het nodig een externe druksensor met een analogo output signaal van 0-10V of 4-20mA te installeren).
- **Bedieningssysteem met MIN/MAX-stand** (hiervoor is het nodig een externe druksensor met een digitaal output signaal, timer of extern relais te installeren).



PROSYS ECOWATT

6.1. BESCHRIJVING

Met de PROSYS ECOWATT kunnen de instellingen gevisualiseerd en gewijzigd worden. Met deze console kunnen de volgende functies uitgevoerd worden.

- Parameters en variabelen weergeven
- Instellingen opslaan
- Instellingen weergeven
- Het apparaat en de bedrijfsmodi configureren
- Units (kanalen) in het netwerk opzoeken (elke unit moet door middel van een afzonderlijk kanaalnummer geconfigureerd zijn)

De console beschikt over een lcd-scherm met 2x16 tekens, 4 knoppen en 3 leds.

- Knop "omhoog"
- Knop "omlaag"
- Knop "+"
- Knop "-"
- Led voeding AAN
- Led activiteit MODBUS
- Led foutmelding

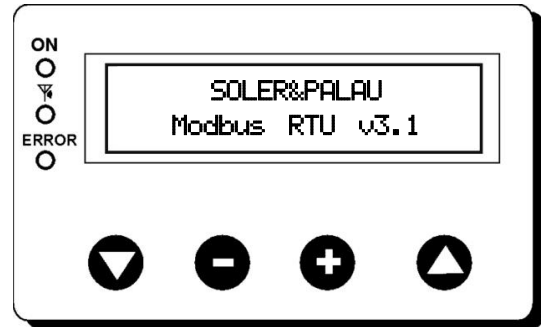

6.2. GEBRUIK VAN DE CONSOLE

Bij het wijzigen van de geconfigureerde parameters hebben de knoppen op de console de volgende functies:

Knop	Functie
	Hogere waarde parameter
	Lagere waarde parameter
	Invoer/Enter
	Afsluiten

Bij het bladeren door de menu's verschilt de functie van de knoppen naargelang de aanduidingen op het scherm. De functie van elke knop wordt boven die knop weergegeven.

Voorbeelden:

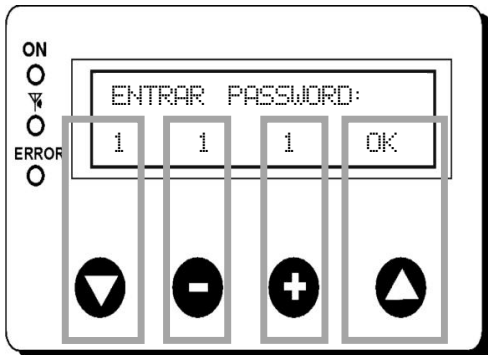

Knop	Functie
	Wijzig de waarde van het eerste cijfer
	Wijzig de waarde van het tweede cijfer
	Wijzig de waarde van het derde cijfer
	OK. Bevestigen

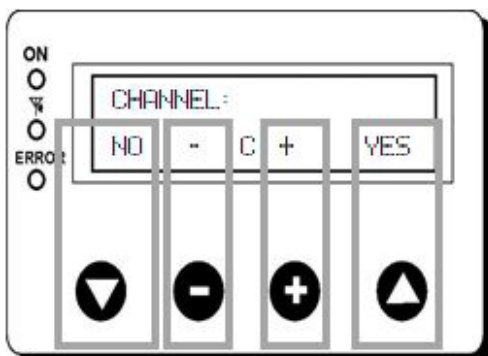

Knop	Functie
	No = afsluiten
	Lager kanaalnummer
	Hoger kanaalnummer
	YES = Bevestigen

6.3. INSTALLATIE

Het is mogelijk om een enkele PROSYS ECOWATT aan één CAB ECOWATT PLUS te koppelen, of door middel van een Modbus-communicatienetwerk meerdere units aan één PROSYS ECOWATT-console te koppelen.

Bedradingsschema individuele bediening

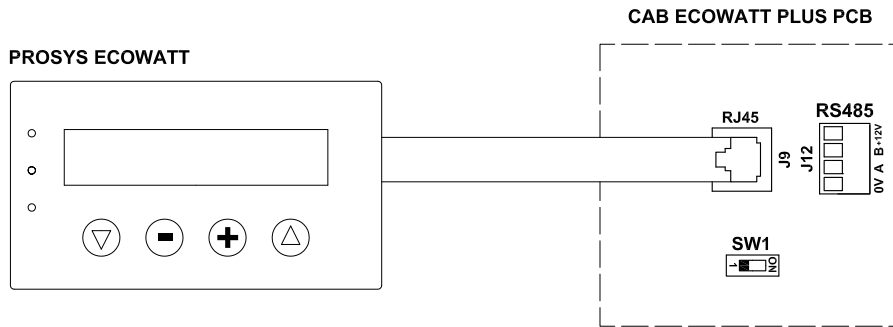

Bedradingsschema meervoudige bediening

Het is mogelijk om tot 32 boxventilatoren te koppelen aan een communicatienetwerk, om op die manier via één PROSYS ECOWATT-console alle ventilatoren aan te sturen.

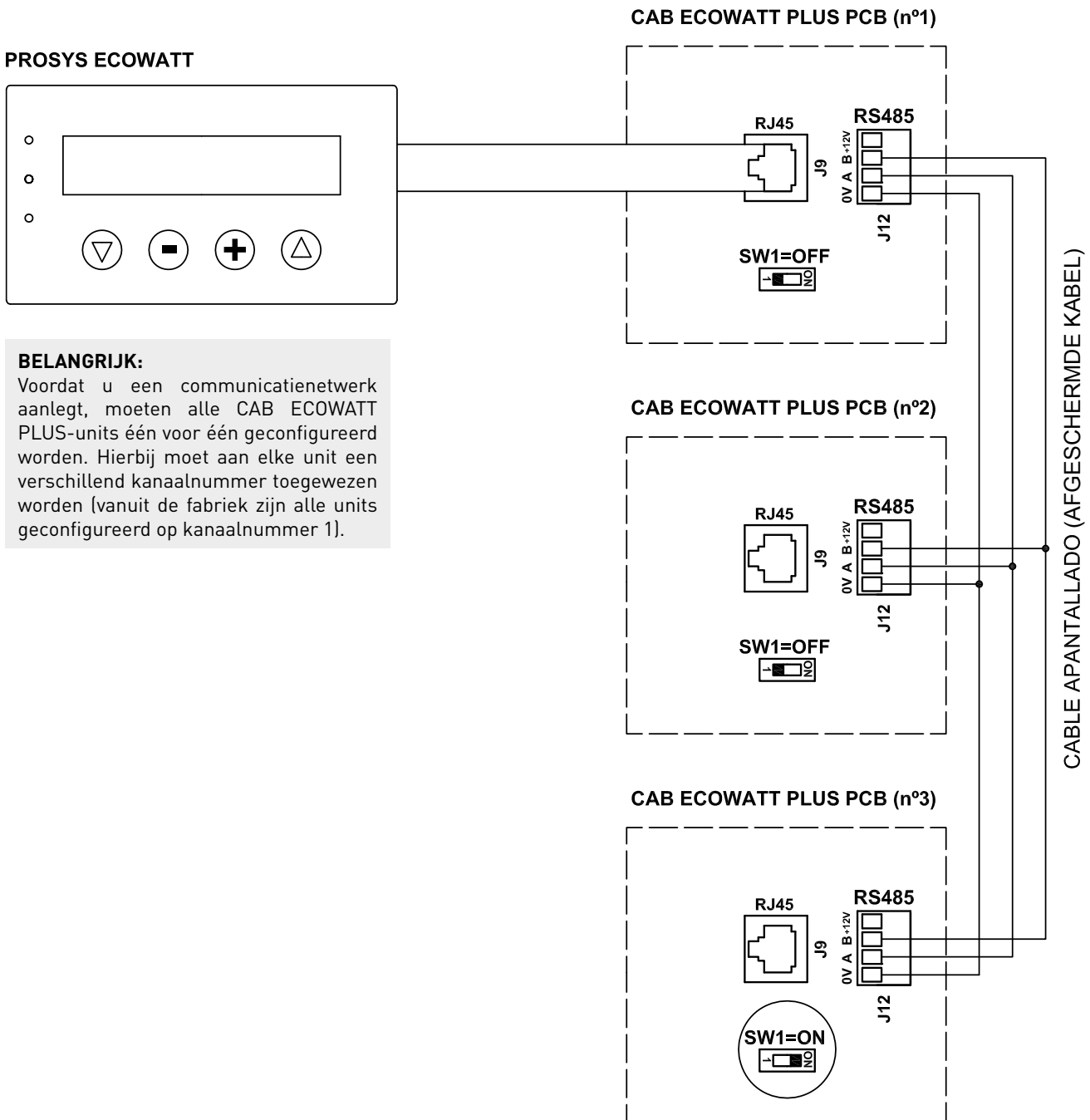

BELANGRIJK:

Voordat u een communicatienetwerk aanlegt, moeten alle CAB ECOWATT PLUS-units één voor één geconfigureerd worden. Hierbij moet aan elke unit een verschillend kanaalnummer toegewezen worden (vanuit de fabriek zijn alle units geconfigureerd op kanaalnummer 1).

Voer de volgende stappen uit om het kanaaladres van een ventilator te wijzigen:

- Controleer dat de schakelaar AAN/UIT op "0" staat
- Ga naar de interne printplaat en zet de microschakelaar SW2-2 op "AAN" (ON)
- Sluit de PROSYS ECOWATT-console aan op de printplaat met de aansluiting J9
- Zet het apparaat aan met de AAN/UIT-schakelaar
- Kies de gewenste taal op het eerste scherm
- Ga verder met de volgende stappen:

NL

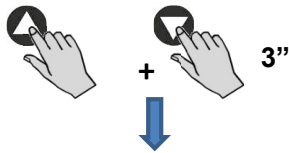

Druk gelijktijdig 3" (seconden)

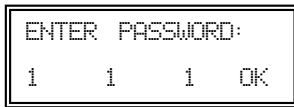

Voer password in
Instelling: 1 1 1

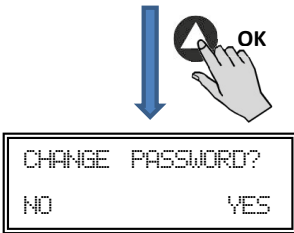

Het is mogelijk ee nieuw password in te voeren.

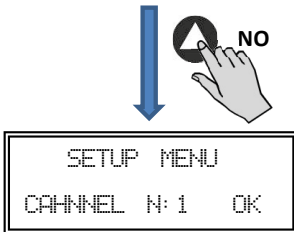

Selecteer het kanaal waar u de ventilator wilt instellen.

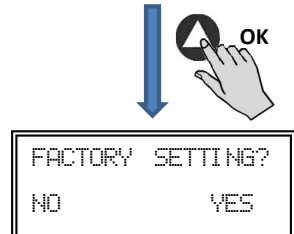

Druk op "NO" als u niet naar de fabriekinstellingen terug wilt.

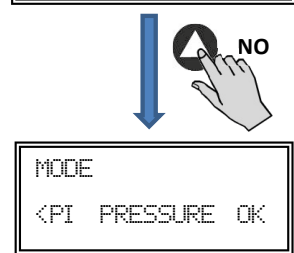

Druk op "OK"

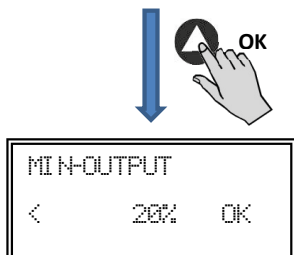

Druk op "OK"



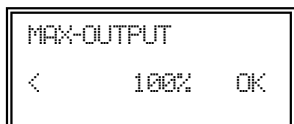

Druk op "OK"

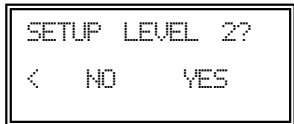
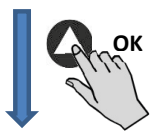

Druk op "NO"

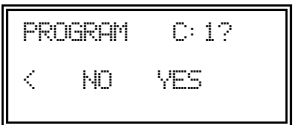
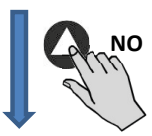

Druk op "YES" om veranderingen te bevestigen

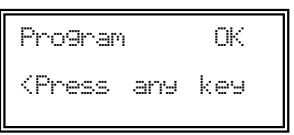
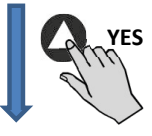

Druk op willekeurige knop om naar het hoofdscherm te gaan.

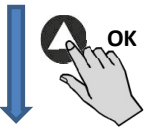

- Schakel het apparaat uit ON/OFF door schakelaar in "0".
- Ga naar interne print en schakel micro switch SW2-2 in "OFF".
- De verandering van de ventilator zal doorgevoerd zijn bij herstart.

Als de PROSYS ECOWATT console verbonden is met de master unit, kunt u elke ventilator benaderen door de toegewezen nummers op te roepen in het scherm. Deze zullen verschijnen wanneer u herhaaldelijk op de  knop drukt op het hoofdscherm.

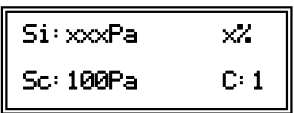

Hoofdscherm

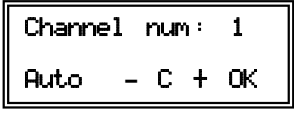
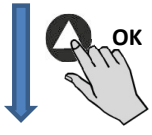

Scherm kanaal veranderen

6.4. ALGEMENE PARAMETERS

Zet het apparaat aan met de AAN/UIT-schakelaar zodra alle kabels aangesloten zijn. Bij het inschakelen van het apparaat verschijnt het volgende scherm:



Nadat u de taal heeft ingesteld verschijnt een scherm met de volgende informatie:

Si: xxxPa	x%
Sc: 100Pa	C: 1

- Si: xxx** Gemeten waarde (eenheid afhankelijk van bedrijfsmodus)
- Sp/Sc: xxx** Geprogrammeerd instelpunt
- X%** Ventilatorsnelheid in % (van de maximale snelheid)
- C: 1** Ventilatornummer, indien aangesloten op netwerk

Als u op de knop  drukt verschijnt een tweede informatiescherm:

RPM: xxx	InD: 0
Rel: 0	C: 1

- RPM: xxx** Ventilatorsnelheid (Aansluiting TACOM-aansluitingen vereist)
- Relais: 0** Geeft aan of de uitgang van het alarmsignaal is aangesloten (0: uitgang niet aangesloten, 1: uitgang aangesloten)
- InD: 0** Digitale ingang (J11 nachtstand of Min/Max)(0: uitgang niet aangesloten, 1: uitgang aangesloten)
- C: 1** Gebruikt communicatiekanaal (tussen 1 en 247)

6.5. OPSTARTEN VAN HET SYSTEEM

Zodra alle eenheden aangesloten en ingesteld zijn, kunt u de voeding van het systeem inschakelen.

Na het inschakelen van het systeem wordt het beginscherm getoond met de softwareversie. Na drie seconden wordt verbinding gemaakt met de units die in het geheugen zijn opgeslagen. Als de communicatie succesvol verloopt, wordt het eerste informatiescherm getoond. Het scherm van de bedrijfsmodus PI DRUK wordt standaard getoond:

PI DRUK/ COP-modus	PI VOLUME/ CAV-modus
Si: 100 Pa 100%	Si: 100 m ³ /h 100%
Sp: 100 Pa C:1	Sp: 100 m ³ /h C:1
PROPORTIONEEL/VAV-modus	MIN-MAX-modus
S2: 30%HR 21%	INLD: ON 21%
C:1	C:1

6.6. CONFIGURATIE UNIT VIA CONSOLE

6.6.1. Wijzig het instelpunt

Te volgen stappen om het instelpunt vanaf het hoofdscherm te wijzigen:

Si: XXX	x%
Sc: XXX	C:1

- Si: xxx** Gemeten waarde (eenheid afhankelijk van bedrijfsmodus)
- Sc: xxx** Setpunt
- X%** Ventilatorsnelheid in % (van de maximale snelheid)
- C: 1** Ventilatornummer, indien aangesloten op netwerk



3"

Press for 3"

SetP CONSOLE:
XXX XXX OK

Druk op **+** of **-** om het instelpunt handmatig te wijzigen

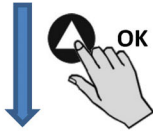

6.6.1. Bedrijfsmodus wijzigen

Zodat de eenheid is ingeschakeld, de taal is gekozen en het bovenstaande scherm wordt getoond, gaat u verder met de volgende stappen:

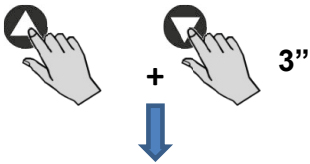

3"

Press simultaneously for 3"
Tegelijkertijd 3 seconden ingedrukt houden

ENTER PASSWORD:
1 1 1 OK

Enter the password
Voer wachtwoord in
Standaard: 1 1 1

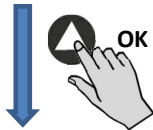

CHANGE PASSWORD
SI NO

It is possible to assign a new password to your device
Het is mogelijk een nieuw wachtwoord aan uw apparaat toe te wijzen (kanaal)

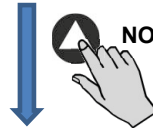

MENU CONFIG
CHANNEL N: 1 OK

Selection on which channel you want to set the
Kanaalkeuze voor configuratie

Op dit moment kunnen we het apparaat configureren en de gewenste parameters kiezen en instellen:

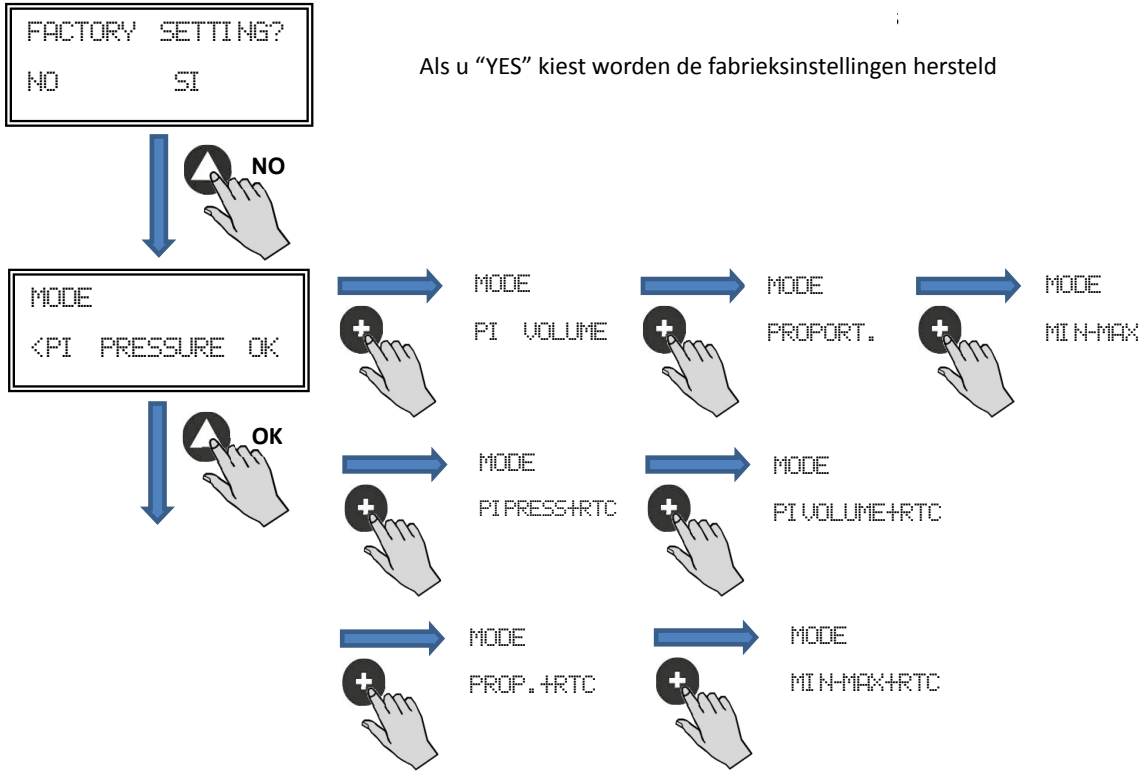

Werking: de getoonde parameters zijn afhankelijk van de ingestelde bedrijfsmodus. De bedrijfsmodi die eindigen op "RTC" werken uitsluitend in combinatie met de optionele programmatimer RTC.

6.6.3. Bedienung PI DRUK/COP-modus

In hoofdstuk 5 hebben we beschreven dat de boxventilator vanuit de fabriek wordt geleverd in de constante drukmodus. Het is echter ook mogelijk om een externe drukomvormer (0-10V of 4-20mA) aan te sluiten op de J5 of J6 aansluitpunten.

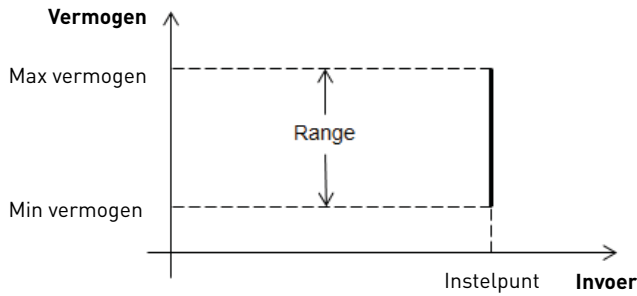

Bedienung PI DRUK/COP-modus

Nadat u de bedrijfsmodus PI DRUK/COP gekozen heeft, kunt u de volgende parameters instellen:

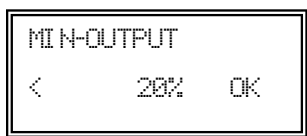

Druk op **+** of **-** om het minimale vermogen van de motor handmatig te wijzigen

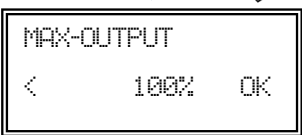
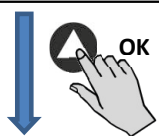

Druk op **+** of **-** om het maximale vermogen van de motor handmatig te wijzigen



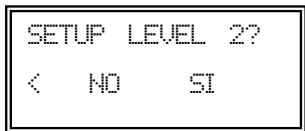

Toegang tot geavanceerde configuratieparameters

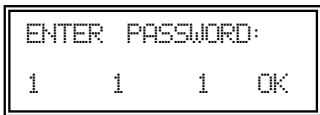
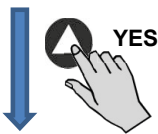

Voer wachtwoord in
Standaard: 1 1 1

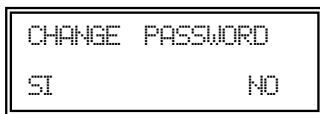
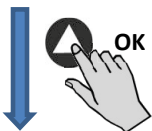

Het is mogelijk een nieuw wachtwoord aan uw apparaat toe te wijzen (kanaal)

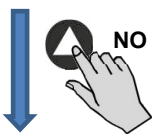

Niet wijzigen

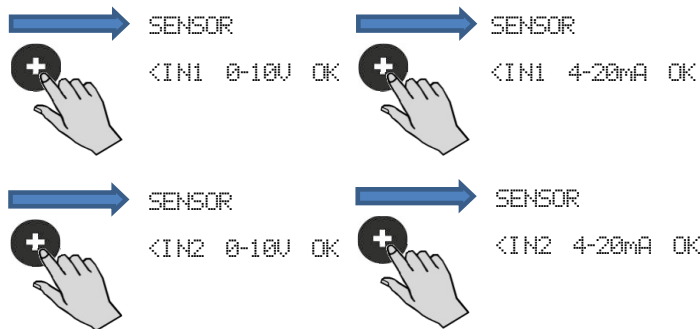
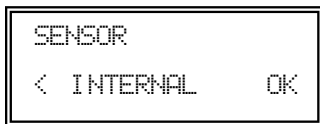
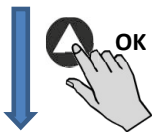

Sensor: Sensortype

- **INTERN:** Interne drukverschilsensor
- **IN1 0-10V:** Externe sensor met analoog signaal 0-10V (aansluiting J5)
- **IN1 4-20mA:** Externe sensor met analoog signaal 4-20mA (aansluiting J5)
- **IN2 0-10V:** Externe sensor met analoog signaal 0-10V (aansluiting J6)
- **IN2 4-20mA:** Externe sensor met analoog signaal 4-20mA (aansluiting J6)

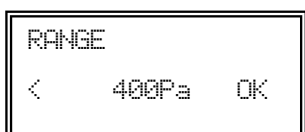

Druk op **+** of **-** om de parameter handmatig te wijzigen. De waarde op het scherm betreft de schaal van de interne sensor, zoals deze in de fabriek is ingesteld. Indien een externe sensor wordt geïnstalleerd, moet het desbetreffende bereik van de meetschaal ingevoerd worden.



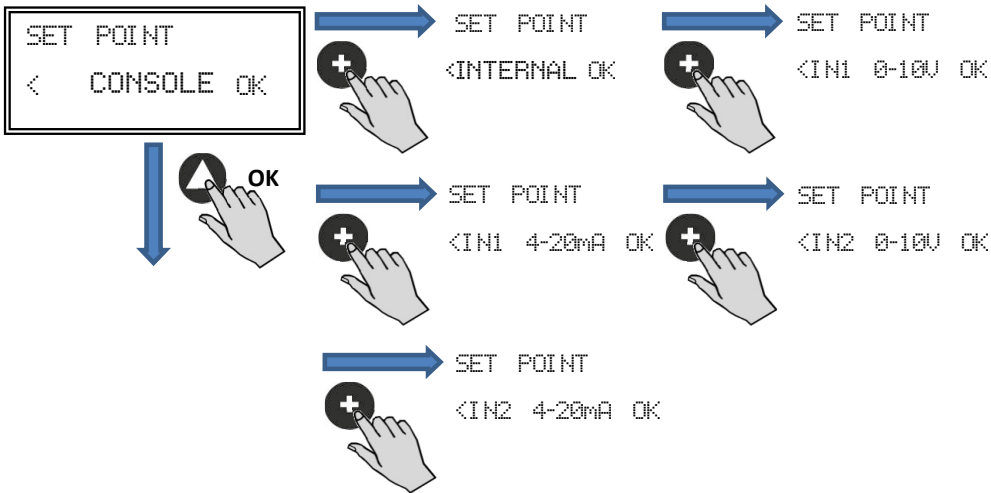

Geprogrammeerd instelpunt:

- **INTERN:**
- **CONSOLE:** Waarde ingesteld door PROSYS ECOWATT-console. Fabrieksinstelling
- **IN1/IN2 0-10V:** Waarde ingesteld door externe potentiometer (0-10V)
- **IN1/IN2 4-20mA:** Waarde ingesteld door externe potentiometer (4-20mA)

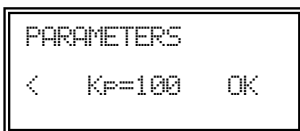

Druk op **+** of **-** indrukken om deze parameter handmatig te wijzigen. Liever niet wijzigen.

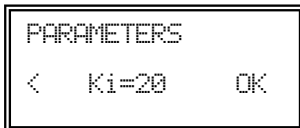

Druk op **+** of **-** indrukken om deze parameter handmatig te wijzigen. Liever niet wijzigen.



Druk op **+** of **-** indrukken om deze parameter handmatig te wijzigen. Liever niet wijzigen.

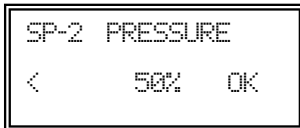

Druk op **+** of **-** om de parameter te wijzigen. De waarde op het scherm betreft het percentage van de ingestelde druk, die overeenkomt met de ventilator in nachtstand. Voor het aansluiten van een programmatimer of een spanningsvrije schakelaar op digitale ingang J11.

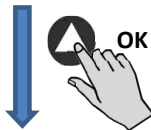

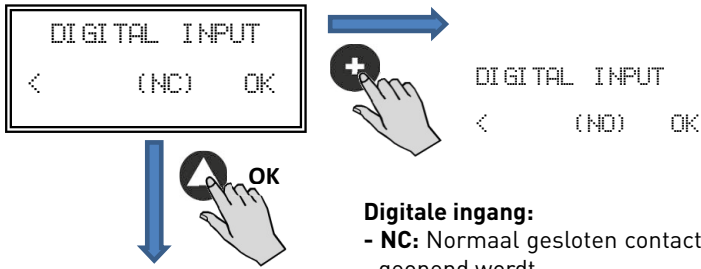

Digitale ingang:

- **NC:** Normaal gesloten contact. De ventilator schakelt over op nachtstand als het contact geopend wordt.
- **NO:** Normaal open contact. De ventilator schakelt over op nachtstand als het contact gesloten wordt.

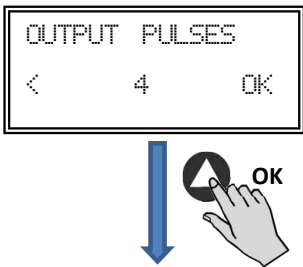

Druk op **+** of **-** om de parameter te wijzigen waarmee de snelheid via de J8-uitvoer (TACOM) wordt weergegeven. Standaardwaarde liever niet wijzigen.

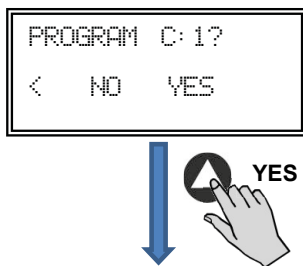

Gewijzigde parameters opslaan

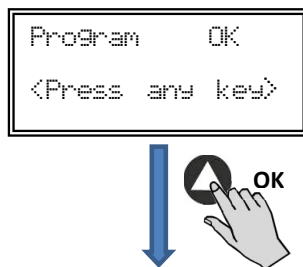

Druk op een willekeurige toets om terug te keren naar het hoofdscherm

6.6.4. Bediening PI VOLUME/CAV-modus

Voordat u met de PROSYS ECOWATT-console de modus PI_VOLUME/CAV selecteert, moet u de configuratie van de drukslangaansluitingen veranderen. Plaats de slangen die gemarkeerd zijn met "V" en "P-" zoals aangegeven in onderstaande afbeelding (het model CAB-125 ECOWATT is niet verkrijgbaar met de bedrijfsmodus PI_VOLUME/CAV).

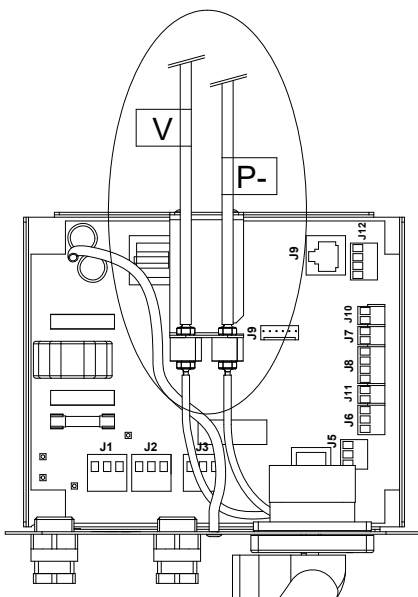

Constant volume (aanzuigzijde)

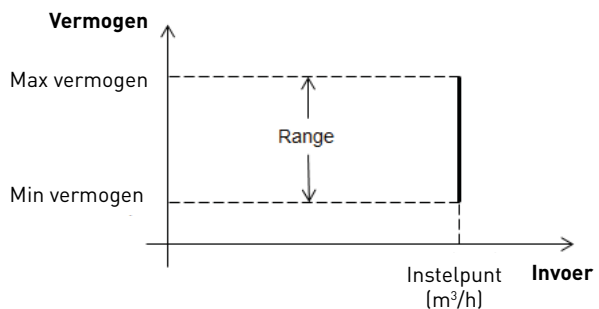

Constant volume

Zodra de bedrijfsmodus is gewijzigd naar PI_VOLUME/CAV verschijnen de volgende parameters:



Druk op **+** of **-** om het minimale vermogen van de motor handmatig te wijzigen

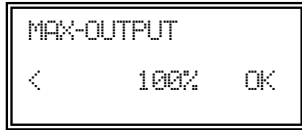
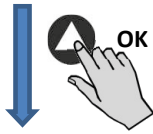

Druk op **+** of **-** om het maximale vermogen van de motor handmatig te wijzigen

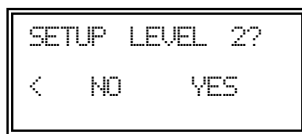
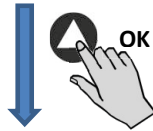

Toegang tot geavanceerde configuratieparameters

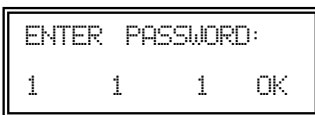
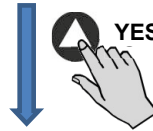

Voer wachtwoord in
Standaard: 1 1 1

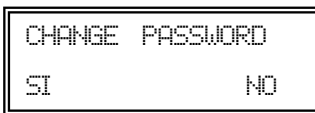
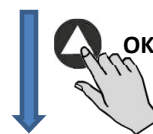

Het is mogelijk een nieuw wachtwoord aan uw apparaat toe te wijzen (kanaal)

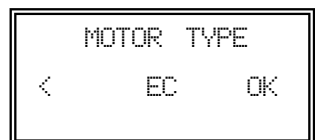

Niet wijzigen

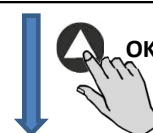

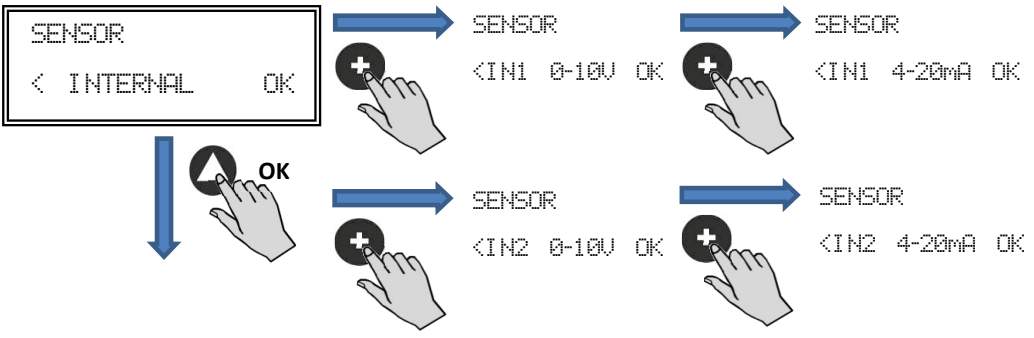

Sensor: Sensortype

- **INTERN:** Interne drukverschilsensor
- **IN1 0-10V:** Externe sensor met analog signaal 0-10V (aansluiting J5)
- **IN1 4-20mA:** Externe sensor met analog signaal 4-20mA (aansluiting J5)
- **IN2 0-10V:** Externe sensor met analog signaal 0-10V (aansluiting J6)
- **IN2 4-20mA:** Externe sensor met analog signaal 4-20mA (aansluiting J6)

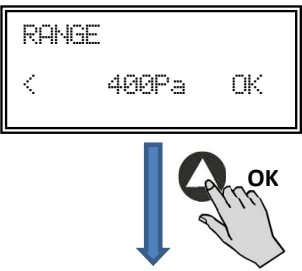

Press **+** or **-** to manually modify the parameter.
 The value displayed corresponds to the scale of the internal sensor factory pre-set. In an external sensor is installed, introduce the corresponding range.

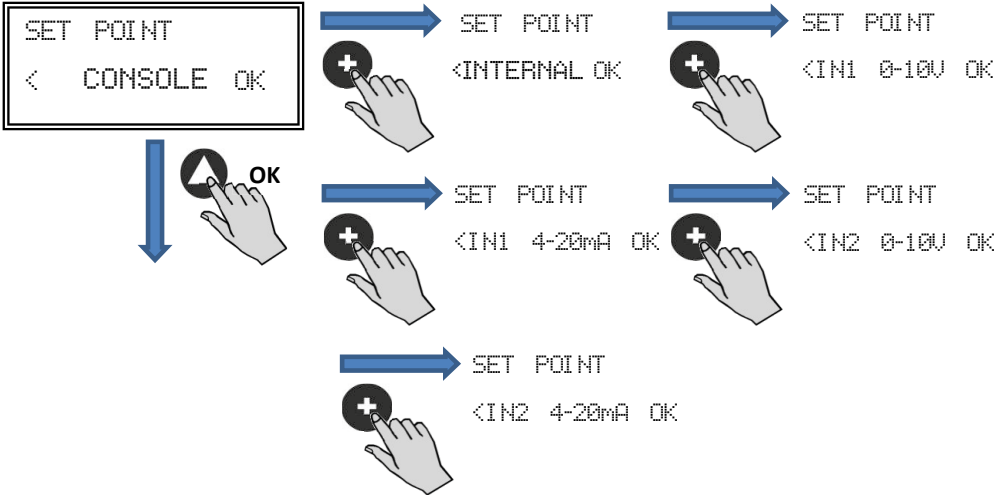

Geprogrammeerd instelpunt:

- **INTERN:**
- **CONSOLE:** Waarde ingesteld door PROSYS ECOWATT-console. Fabrieksinstelling
- **IN1/IN2 0-10V:** Waarde ingesteld door externe potentiometer (0-10V)
- **IN1/IN2 4-20mA:** Waarde ingesteld door externe potentiometer (4-20mA)

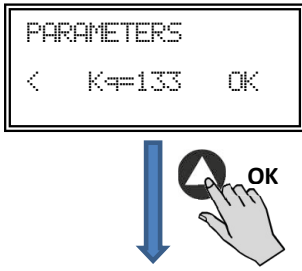

Druk op **+** of **-** indrukken om deze parameter handmatig te wijzigen.
 Liever niet wijzigen.

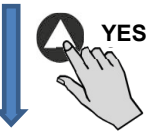
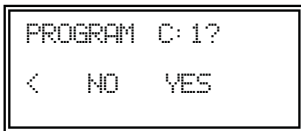
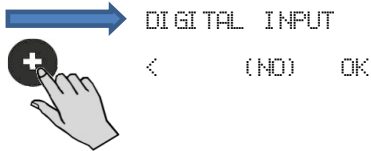
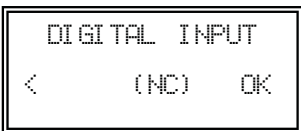
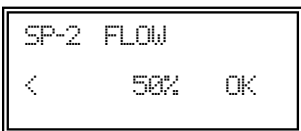
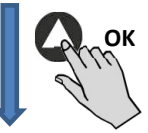
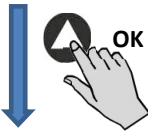
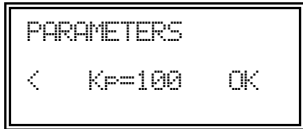

Druk op **+** of **-** indrukken om deze parameter handmatig te wijzigen. Liever niet wijzigen.

Druk op **+** of **-** indrukken om deze parameter handmatig te wijzigen. Liever niet wijzigen.

Druk op **+** of **-** indrukken om deze parameter handmatig te wijzigen. Liever niet wijzigen.

Druk op **+** of **-** om de parameter te wijzigen. De waarde op het scherm betreft het percentage van de ingestelde druk, die overeenkomt met de ventilator in nachtstand. Voor het aansluiten van een programmatimer of een spanningsvrije schakelaar op digitale ingang J11.

Digitale ingang:

- **NC:** Normaal gesloten contact. De ventilator schakelt over op nachtstand als het contact geopend wordt.
- **NO:** Normaal open contact. De ventilator schakelt over op nachtstand als het contact gesloten wordt.

Druk op **+** of **-** om de parameter te wijzigen waarmee de snelheid via de J8-uitvoer (TACOM) wordt weergegeven. Standaardwaarde liever niet wijzigen.

Gewijzigde parameters opslaan

Program OK
<Pulsar tecla>

Druk op een willekeurige toets om terug te keren naar het hoofdscherm



6.6.5. Bediening PROPORTIONEEL/VAV-modus

In deze stand kan de boxventilator werken met één of twee analoge ingangssignalen (4-20mA of 0-10V). De boxventilator werkt volgens de parameter met de grootste vraag. De sensoren worden aangesloten op de analoge ingangsaansluitingen J5 en/of J6.

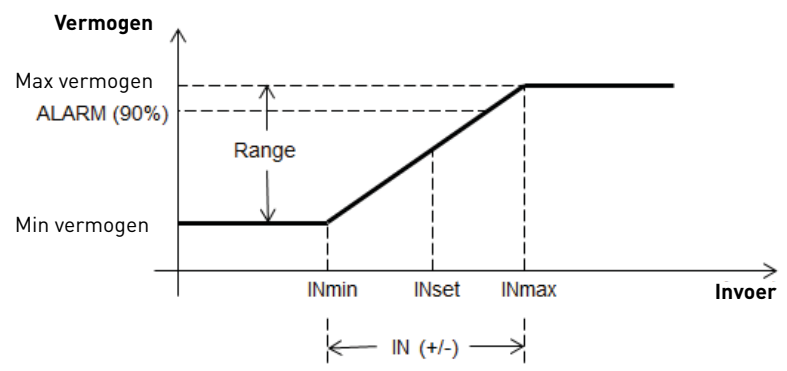

Bediening PROPORTIONEEL/VAV-modus

Zodra de bedrijfsmodus is gewijzigd naar PROPORTIONEEL/VAV verschijnen de volgende parameters:

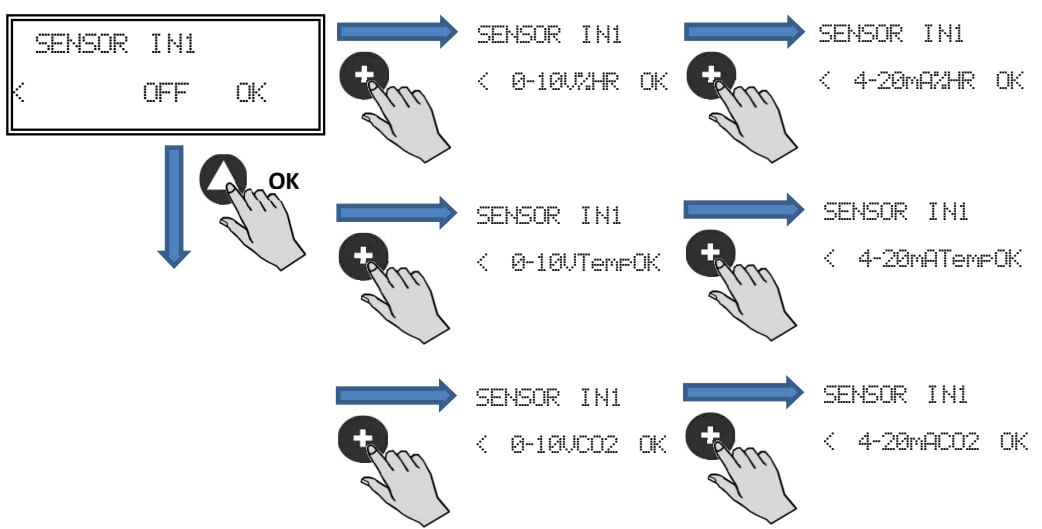

Sensor IN1:

- **GEEN SENSOR:** Geen sensor aangesloten op deze ingang
- **0-10V/4-20mA %HR:** Luchtvochtigheidssensor met analog uitgangssignaal 0-10V/4-20mA
- **0-10V/4-20mA TEMP:** Temperatuursensor met analog uitgangssignaal 0-10V/4-20mA
- **0-10V/4-20mA CO2:** CO2-sensor met analog uitgangssignaal 0-10V/4-20mA

IN1 RANGE
< 100%HR OK

Druk op **+** of **-** om de schaal van de externe sensor te wijzigen



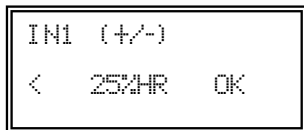
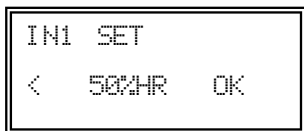

Druk op **+** of **-** om het middelste gebruiksbereik (range) handmatig te wijzigen

Druk op **+** of **-** om de breedte van het verstelbereik van de sensor handmatig te wijzigen

Follow the same process if you select a different sensor type or activated the second input analog signal **SENSOR IN2**.

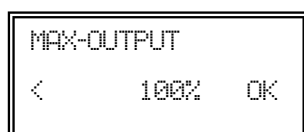
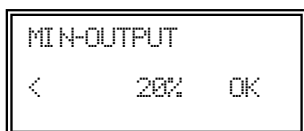

Druk op **+** of **-** om de minimale vermogensparameter naar de motor te wijzigen

Druk op **+** of **-** om de maximale vermogensparameter naar de motor te wijzigen

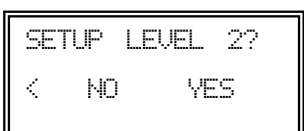

Toegang tot geavanceerde configuratieparameters

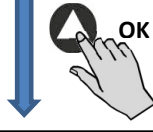
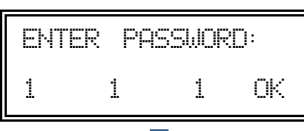

Voer wachtwoord in
Standaard: 1 1 1

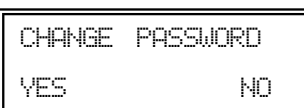

Het is mogelijk een nieuw wachtwoord aan uw apparaat toe te wijzen (kanaal)

MOTOR TYPE
< EC OK

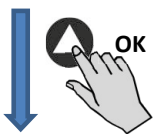

S1-ALARM
< 90% OK



S2-ALARM
< 90% OK



MIN RPM-ALARM
< 500 OK



OUTPUT PULSES
< 4 OK



PROGRAM C: 1?
< NO YES

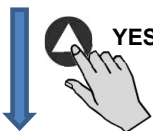

Program OK
<Press any key>



Niet wijzigen

Druk op **+** of **-** om deze parameter handmatig te wijzigen. Met deze waarde kunt u een alarmbericht versturen als de waarde die gemeten wordt door sensor IN1 een bepaald percentage van het meetbereik (range) bereikt

Druk op **+** of **-** om deze parameter handmatig te wijzigen. Met deze waarde kunt u een alarmbericht versturen als de waarde die gemeten wordt door sensor IN2 een bepaald percentage van het meetbereik (range) bereikt.

Druk op **+** of **-** om deze parameter handmatig te wijzigen. Met deze waarde kunt u een alarmbericht versturen als de ventilatorsnelheid een bepaalde minimumwaarde bereikt.

Druk op **+** of **-** om de parameter te wijzigen waarmee de snelheid via de J8-uitvoer (TACOM) wordt weergegeven. Standaardwaarde liever niet wijzigen.

Gewijzigde parameters opslaan

Druk op een willekeurige toets om terug te keren naar het hoofdscherm

6.6.6. Bedrijfsmodus MIN/MAX

In deze stand werkt het bedieningskastje met het contacttype normaal open (NO) of normaal gesloten (NC). Deze bevindt zich bij de digitale ingang J11. Als de status van deze ingang gewijzigd wordt, schakelt de ventilator over naar een lagere snelheid, een bepaald percentage van de maximale snelheid.

Logica:

- NO (normaal open): De ventilator schakelt over op lage snelheid als het contact sluit.
- NC (normaal gesloten): De ventilator schakelt over op lage snelheid als het contact opent.

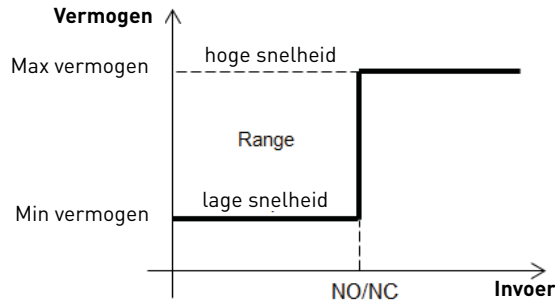

Bedrijfsmodus MIN/MAX

Zodra de bedrijfsmodus is gewijzigd naar MIN/MAX verschijnen de volgende parameters:

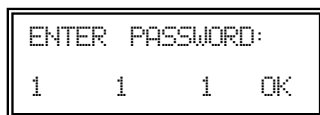
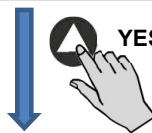
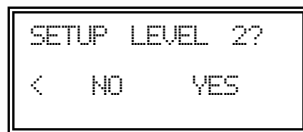
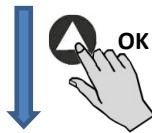
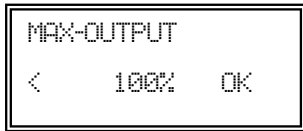
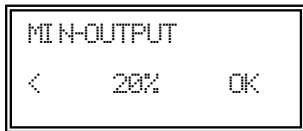

Druk op **+** of **-** om het minimale vermogen van de motor handmatig te wijzigen

Druk op **+** of **-** om het maximale vermogen van de motor handmatig te wijzigen

Toegang tot geavanceerde configuratieparameters

Voer wachtwoord in
Standaard: 1 1 1

CHANGE PASSWORD
YES NO

Het is mogelijk een nieuw wachtwoord aan uw apparaat toe te wijzen (kanaal)

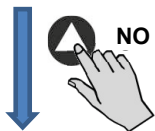

MOTOR TYPE
< EC OK

Niet wijzigen



DIGITAL INPUT
< (NO) OK

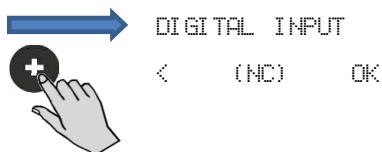

Digitale ingang:

- **NC:** Normaal gesloten contact. De ventilator schakelt over op nachtstand als het contact geopend wordt.
- **NO:** Normaal open contact. De ventilator schakelt over op nachtstand als het contact gesloten wordt.

OUTPUT PULSES
< 4 OK

Druk op **+** of **-** om de parameter te wijzigen waarmee de snelheid via de J8-uitvoer (TACOM) wordt weergegeven. Standaardwaarde liever niet wijzigen.



PROGRAM C: 1?
< NO YES

Gewijzigde parameters opslaan



Program OK
<Press any key>

Druk op een willekeurige toets om terug te keren naar het hoofdscherm

7. BEDIENING MET OPTIONELE PROGRAMMATIMER RTC ECOWATT EN PROSYS ECOWATT-CONSOLE

Als u de programmeertimer **RTC ECOWATT** aanschaft (verkrijgbaar als accessoire) heeft u toegang tot de functies in hoofdstuk 6 "Bediening met PROSYS ECOWATT-console [accessoire]" en kunt u tevens de volgende functies programmeren:

- **Tot drie periodes per dag met bijbehorende instelpunten.**
- **Vakantieperiode**, waarbij de begin- en einddatum en -tijdstip van de vakantie ingesteld kan worden, evenals het percentage dat de ventilator van de maximale snelheid moet draaien.

7.1. INSTALLATIE

Zoals in onderstaande afbeelding wordt getoond is dit accessoire een elektronische component die in de boxventilator geïnstalleerd moet worden.

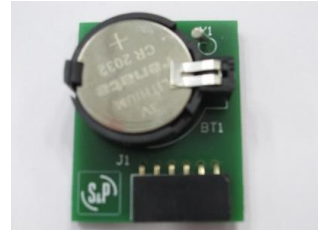

PROGRAMMEERTIMER RTC ECOWATT

Voer de volgende stappen uit om dit correct uit te voeren:

1. Schakel de stroomvoorziening uit met de AAN/UIT-schakelaar aan de voorzijde.
2. Open de boxventilator
3. Zoek de aansluiting J4

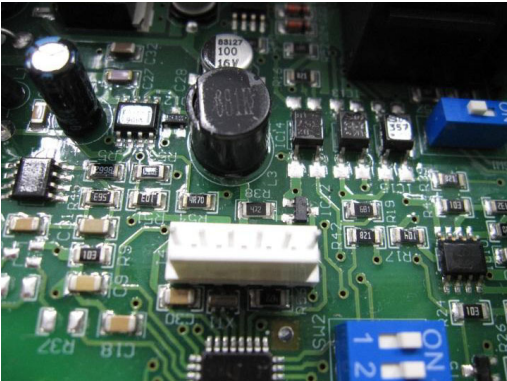

4. Pas de stekker van de programmatimer RTC ECOWATT op de aansluitpennen J4.

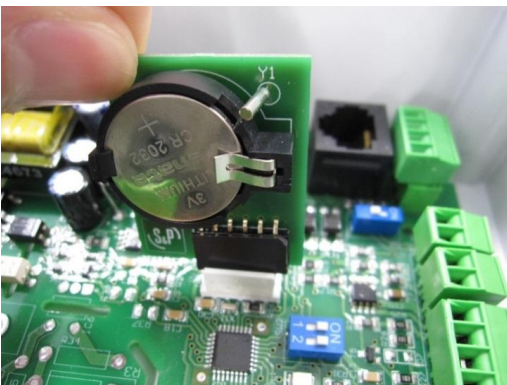

5. Bevestig de elektronica door het printplaatje naar beneden te duwen.



OPMERKING: Na installatie drukt u tweemaal op de knop  op de console PROSYS ECOWATT om de datum en de tijd weer te geven.

7.2. PROGRAMMEREN

BELANGRIJK: Voordat u begint met de programmering is het belangrijk de desbetreffende bedrijfsmodus te kiezen. Zie punt 6.6.1. Bedrijfsmodus wijzigen van deze handleiding, en kies één van deze modi: PI DRUK, PI VOLUME+RTC, PROPORTIONEEL+RTC of MIN-MAX+RTC.

Tijdens het programmeren moeten de volgende parameters gedefinieerd worden:

- **T1, T2, T3:** Starttijd voor elke tijdsperiode (UIT, 00:00-23:59).
- **Periode T1, Periode T2, Periode T3:** Minuten van elke tijdsperiode, in verhouding tot de gedefinieerde starttijd (tot 480 minuten).
- **Instelpunt T1, Instelpunt: T2, Instelpunt: T3:** Instelpunt in percentage tijdens de tijdsperiode, ten opzichte van de eerder geselecteerde bedrijfsmodus (als bijvoorbeeld de modus PI_DRUK+RTC geselecteerd is, en het instelpunt T1 is 50%, zal tijdens deze tijdsperiode de snelheid van de boxventilator afnemen met 50% ten opzichte van de ingestelde druk SC).

Voorbeeld:

	MAANDAG	DINSDAG	...	ZATERDAG	ZONDAG
1:00	T3 = 480 min SetpointT3 = 25%	T3 = 480 min SetpointT3 = 25%	...	T3 = 480 min SetpointT3 = 25%	T3 = 480 min SetpointT3 = 25%
2:00					
3:00					
4:00					
5:00					
6:00					
7:00					
8:00				T1 = 60 min SetpointT1 = 50%	T1 = 60 min SetpointT1 = 50%
9:00				T2 = 120 min SetpointT1 = 50%	T2 = 120 min SetpointT1 = 50%
10:00	T1 = 60 min SetpointT1 = 50%	T1 = 60 min SetpointT1 = 50%			
11:00					
12:00					
13:00					
14:00	T2 = 120 min SetpointT1 = 50%	T2 = 120 min SetpointT1 = 50%	...		
15:00					
16:00					
22:00					
23:00	T3 = 480 min SetpointT3 = 25%	T3 = 480 min SetpointT3 = 25%	...	T3 = 480 min SetpointT3 = 25%	T3 = 480 min SetpointT3 = 25%
0:00					

Als één van deze modi geselecteerd is, kunt u op de volgende manier een programma instellen:

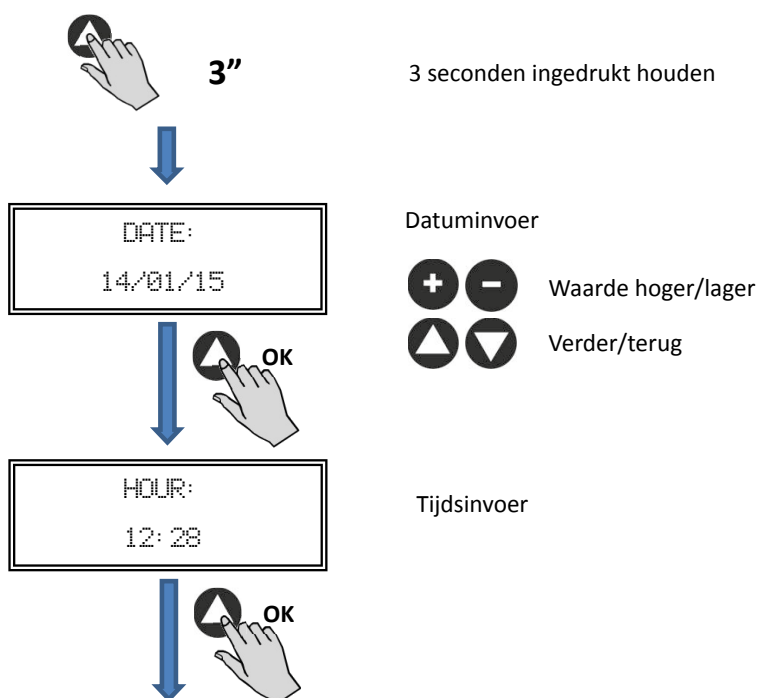

EXIT?
CONT YES

Op YES drukken, terug naar hoofdscherm
Op CONT drukken, verder programmeren

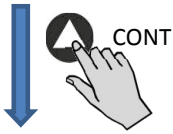

MONDAY
T1 09:00

Starttijd voor de periode T1 op maandag

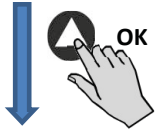

MONDAY
T2 11:00

Starttijd voor de periode T2 op maandag

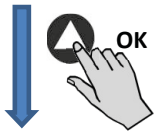

MONDAY
T3 14:00

Starttijd voor de periode T3 op maandag



TUESDAY
NO SAME? SI

Bij accepteren wordt het programma van maandag naar dinsdag gekopieerd

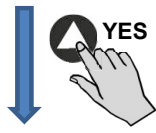

PERIOD T1
5 m

Invoer tijdsperiode T1 (0-480 min)

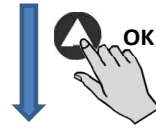

PERIOD T2
15 m

Invoer tijdsperiode T2 (0-480 min)

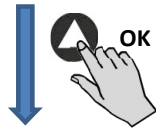

SET T1
80

Instelpunt in % tijdens tijdsperiode in verhouding tot eerder geselecteerde bedrijfmodus (UIT, 0-100%)

Verder met procedure

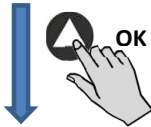

DATE START
19/12/14

Begindatum vakantieperiode

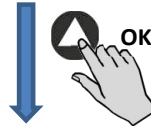

HOUR START
14:58

Begintijd vakantieperiode

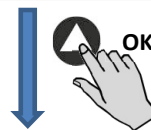

DATE END
30/12/14

Einddatum vakantieperiode

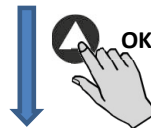

HOUR END
20:00

Eindtijd vakantieperiode

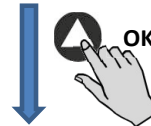

SET HOLIDAYS
20%

Percentage ten opzichte van instelpunt voor vakantieperiode



EXIT?
NO YES

Instellingen bevestigen

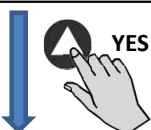

Program OK
<Press any key>

Bevestigen programma



7.3. SAMENVATTING TABEL INSTELWAARDEN

Register	Min.	Max.	Beschrijving
T1 T2 T3	UIT	23:59	Starttijd programma
Period T1 Period T2 Period T3	0min	480min	Tijdsduur programma
Set T1 Set T2 Set T3	UIT	100%	Percentage in verhouding tot instelpunt
Startdatum	00:00	23:59	Startdatum vakantieperiode
Begintijdstip	00:00	23:59	Starttijdstip vakantieperiode
Einddatum	00:00	23:59	Einddatum vakantieperiode
Eindtijdstip	00:00	23:59	Eindtijdstip vakantieperiode
Ingestelde vakanties	UIT	100%	Percentage ten opzichte van het instelpunt voor vakantieperiodes

8. INTEGRATIE MODBUS-COMMUNICATIESYSTEEM

8.1. BASISFUNCTIES VAN DE MODBUS-RTU BEDIENING

Adressen toewijzen	Slave: instelbaar adres tussen 1 tot 247	Master: in staat om slaves aan te spreken met adressen tussen 1 tot 247
Diffusie	Ja	
Verbindingssnelheid	9600 (19200 tevens aanbevolen)	
Pariteit	PAR/EVEN	
Modus	RTU	
Elektrische interface	RS485 2W-met kabel of RS232	
Stekkertype	RJ 45	

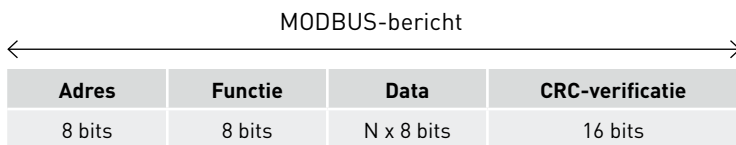

Indeling voor elke byte in RTU-modus is:

- Coderingsysteem: 8-bit binair
- Bits per Byte: 1 startbit (start)
8 databits, meest significante bit wordt eerst verstuurd
1 bit voor pariteit (even pariteit is vereist)
1 stopbit (eind)

8.2. GEHEUGENKAART MODBUS

Holding registers

Reg.nr.	Register	Min.	Max.	Beschrijving	Standaardinstelling	Opmerkingen
0	TipoMotor	0	1	0=AC (wisselstroom) 1=DC (gelijkstroom)	1	Motortype
1	ModoFun	0	7	0=PI_Druk 1=PI_Volume 2=Proportioneel 3=Max-Min 4=PI_Druk+RTC 5=PI_Volume+RTC 6=Proportioneel+RTC 7=Max-Min+RTC	0	Bedrijfsmodus
2	SensorPI	0	4	0=Intern 1=IN1 0-10V 2=IN1 4-20mA 3=IN2 0-10V 4=IN2 4-20mA	0	Sensortype in PI_DRUK of PI_VOLUME-modus
3	Sensor1	0	7	0=GEEN 1=0-10V %HR 2=4-20mA %HR 3=0-10V °C 4=4-20mA °C 5=0-10V CO2 6=4-20mA CO2 7=NTC 100K	0	Sensortype in PROPORTIONELE modus en analoge ingangssignaal 1
4	Sensor2	0	6	0=GEEN 1=0-10V %HR 2=4-20mA %HR 3=0-10V °C 4=4-20mA °C 5=0-10V CO2 6=4-20mA CO2	0	Sensortype in PROPORTIONELE modus en analoge ingangssignaal 2
5	PIRange	50 50 100	1250 2500 9900	SensorPI=0 SensorPI<>0 Sensor<<>0	400 (CAB-125/150/160 ECOWATT) 500 (CAB-200/315 ECOWATT) 650 (CAB-250 ECOWATT) 550 (CAB-355/400 ECOWATT)	Rangesensor in PI DRUK-modus
6	SetPoint	0	5	0=Intern 1=IN1 0-10V 2=IN1 4-20mA 3=IN2 0-10V 4=IN2 4-20mA 5=ConsolaMODBUS (PROSYS ECOWATT)	5	Geprogrammeerd instelpunt in PI DRUK-modus
7	Kp	1	250	Stappen van 1	20	Proportioneel constant in PI DRUK-modus
8	Ki	1	250	Stappen van 1	20	Integraal constant in PI DRUK-modus
9	Kq	50	300	Stappen van 1	50 (CAB-125 ECOWATT) 56 (CAB-150/160 ECOWATT) 81 (CAB-200 ECOWATT) 88 (CAB-250 ECOWATT) 108 (CAB-315 ECOWATT) 136 (CAB-355 ECOWATT) 81 (CAB-400 ECOWATT)	Luchtdebiet constant met druksensor
10	PulsosEncoder	0	16	Stappen van 1	2 5 1	Aantal pulsen per omwenteling encoder
11	MinOut	0	50	Stappen van 5%	25	Minimale uitgangswaarde
12	MaxOut	50	100	Stappen van 5%	100	Maximale uitgangswaarde
13	S1Alarm	0	100	Stappen van 5%	90	Alarm analoge ingang 1

Reg.nr.	Register	Min.	Max.	Beschrijving	Standaardinstelling	Opmerkingen
14	S2Alarm	0	100	Stappen van 5%	90	Alarm analoge ingang 2
15	MinRPM	100	500	Stappen van 100	300	Min RPM alarm
16	VacMIN	80	150	Stappen van 10	80	Minimumspanning wisselstroommotor
17	IN1 Range	0 0 0	100 50 2000	Stappen van %HR Stappen van °C Stappen van PPM	100	Achtergrondschaal in proportionele modus ingang 1
18	IN2 Range	0 0 0	100 50 2000	Stappen van %HR Stappen van °C Stappen van PPM	2000	Achtergrondschaal in proportionele modus ingang 2
19	IN1 Set	0	IN1 Range	Stappen van 1	70	Achtergrondschaal in proportionele modus ingang 1
20	IN1 Banda	0	IN1 Range	Stappen van 1	40	Marge (+/-) gecentreerd in IN1 Set
21	IN2 Set	0	IN2 Range	Stappen van 1	1000	Instelpunt proportionele modus ingang 2
22	IN2 Banda	0	IN2 Range	Stappen van 1	1000	Marge (+/-) gecentreerd in IN2 Set
23	InD	0	1	0=GEEN 1=NC	0	Inversie digitale ingang
24	setMODBUS	1	PIRange	Stappen van 50	100 (CAB-125 ECOWATT) 150 (CAB-150/160/200/150/315 ECOWATT) 200 (CAB-355/400 ECOWATT)	MODBUS instelpunt
25	IDIOMA	0	3	0=ENGELS 1=SPAANS 2=FRANS 3=DUITS	0	Taal
26	SP-2 PRESION	25	100	Stappen van 1	25	Instelpunt nacht in PI DRUK-modus
27	SP-2 CAUDAL	50	100	Stappen van 1	50	Instelpunt nacht in PI VOLUME-modus
28	SP Temp	-10	50	Stappen van 1		Instelpunt temperatuur (alleen voor modellen CTBH ECOWATT)
29	adMODBUS	1 0	247 100	Stappen van 1	1	
30	ALARMA	0	1			
31	FECHA	0x0000	0xfe7f	Dag/maand/jaar	0x088E	Huidige datum
32	HORA	0x0000	0x3dfb	Uren/minuten	0x0000	Huidige datum
33	LUNES T1	0x0000	0x063b	Uren/minuten	0x0200	Start periode 1 maandag
34	LUNES T2	0x0000	0x063b	Uren/minuten	0x0300	Start periode 2 maandag
35	LUNES T3	0x0000	0x063b	Uren/minuten	0x0480	Start periode 3 maandag
36	MARTES T1	0x0000	0x063b	Uren/minuten	0x0200	Start periode 1 dinsdag
37	MARTES T2	0x0000	0x063b	Uren/minuten	0x0300	Start periode 2 dinsdag
38	MARTES T3	0x0000	0x063b	Uren/minuten	0x0480	Start periode 3 dinsdag
39	MIERCOLES T1	0x0000	0x063b	Uren/minuten	0x0200	Start periode 1 woensdag
40	MIERCOLES T2	0x0000	0x063b	Uren/minuten	0x0300	Start periode 2 woensdag
41	MIERCOLES T3	0x0000	0x063b	Uren/minuten	0x0480	Start periode 3 woensdag
42	JUEVES T1	0x0000	0x063b	Uren/minuten	0x0200	Start periode 1 donderdag
43	JUEVES T2	0x0000	0x063b	Uren/minuten	0x0300	Start periode 2 donderdag
44	JUEVES T3	0x0000	0x063b	Uren/minuten	0x0480	Start periode 3 donderdag
45	VIERNES T1	0x0000	0x063b	Uren/minuten	0x0200	Start periode 1 vrijdag

Reg.nr.	Register	Min.	Max.	Beschrijving	Standaardinstelling	Opmerkingen
46	VIERNES T2	0x0000	0x063b	Uren/minuten	0x0300	Start periode 2 vrijdag
47	VIERNES T3	0x0000	0x063b	Uren/minuten	0x0480	Start periode 3 vrijdag
48	SABADO T1	0x0000	0x063b	Uren/minuten	0x0200	Start periode 1 zaterdag
49	SABADO T2	0x0000	0x063b	Uren/minuten	0x0300	Start periode 2 zaterdag
50	SABADO T3	0x0000	0x063b	Uren/minuten	0x0480	Start periode 3 zaterdag
51	DOMINGO T1	0x0000	0x063b	Uren/minuten	0x0200	Start periode 1 zondag
52	DOMINGO T2	0x0000	0x063b	Uren/minuten	0x0300	Start periode 2 zondag
53	DOMINGO T3	0x0000	0x063b	Uren/minuten	0x0480	Start periode 3 zondag
54	TIEMPO T1	0	480	1	60	Tijd in minuten voor periode 1
55	TIEMPO T2	0	480	1	60	Tijd in minuten voor periode 2
56	TIEMPO T3	0	480	1	60	Tijd in minuten voor periode 3
57	CONSIGNA T1	0	100	1	80	Percentage over instelpunt
58	CONSIGNA T2	0	100	1	60	Percentage over instelpunt
59	CONSIGNA T3	0	100	1	100	Percentage over instelpunt
60	FECHA INICIO	0	0xfe7f	Dag/maand/jaar	0x088E	Begindatum vakantieperiode
61	HORA INICIO	0x0000	0x063b	Uren/minuten	0	Tijdstip begin vakantieperiode
62	FECHA FIN	0	0xfe7f	Dag/maand/jaar	0x088E	Einddatum vakantieperiode
63	HORA FIN	0x0000	0x063b	Uren/minuten	0	Tijdstip einde vakantieperiode
64	CONSIGNA VAC	0	100	1	20	Instelling vakantieperiode
65	VERSION	0	250	1		Alleen-lezen
66	BAUD	0	3	0=19200 1=9600 2=4800 3=2400	1	Versnelling transmissie
67	PARITEIT	0	2	0=No 1=Even 2=Odd	1	Pariteit Modbus netwerk

Input registers (Alleen-lezen)

Register	Min.	Max.	Beschrijving	Standaardinstelling	Opmerkingen	Opmerkingen
0	Pote	0	255	Potentiometer RV1 PCB		Potentiometer RV1
1	In1	0	255	Analoge ingang 1		Analoge ingang 1
2	In2	0	255	Analoge ingang 2		Analoge ingang 2
3	Intern	0	1250	Interne druksensor		Interne druksensor
4	Rpm	0	6000	Snelheid motor		Snelheid motor (als rpm<100, rpm=0)

Discrete ingang (alleen-lezen)

Register	Min.	Max.	Beschrijving	Standaardinstelling	Opmerkingen	Opmerkingen
0	InD	0	1	Digitale ingang		Digitale ingang

Uitgang batterij (alleen-lezen)

Register	Min.	Max.	Beschrijving	Standaardinstelling	Opmerkingen	Opmerkingen
0	Uitgang	0	1	Relais		Relais

9. ONDERHOUD

Voordat u de boxventilator opent, moet u zeker weten dat deze is losgekoppeld van de netspanning, nadat u deze eerst heeft uitgeschakeld. Voorkom dat iemand anders de boxventilator kan aansluiten terwijl hieraan gewerkt wordt.

De ventilatoren moeten regelmatig geïnspecteerd worden. Deze inspecties moeten uitgevoerd worden met inachtneming van de bedrijfsomstandigheden van de machine, zodat er geen vuil en stof op de ventilatorschoepen, waaier, motor of rooster ophoopt. Dit kan gevaarlijke situaties opleveren en de levensduur van de boxventilator verkorten.

Bij het reinigen moet u ervoor zorgen dat de ventilatorschoepen of waaier niet uit balans gebracht worden.

Alle onderhoud- en reparatiewerkzaamheden moeten uitgevoerd worden met inachtneming van de huidige veiligheidsvoorschriften van elk land.

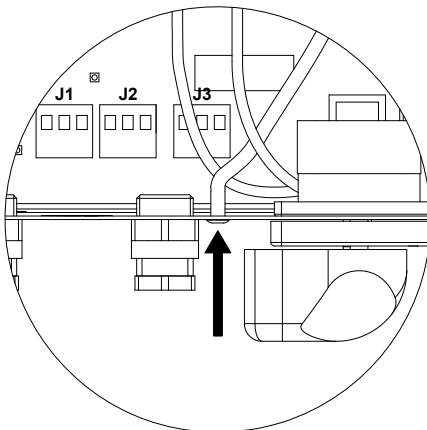

Controleer of het gat van de omgevingsdrukslang schoon is. Ophoping van vuil zal de meting vervalsen en een abnormale werking veroorzaken.

10. BUITENGEBRUIKSTELLING EN RECYCLAGE



De regelgeving van de EG en onze verplichtingen t.o.v. de komende generaties verplichten ons materialen te recyclen. Wij verzoeken u dringend de verpakkingsresten in de overeenkomstige recyclagecontainer te deponeren. Als uw apparaat ook van dit symbool is voorzien, wilt u het dan afvoeren bij een milieustraat, wanneer het niet meer te maken is.



S&P SISTEMAS DE VENTILACIÓN, S.L.U.

C. Llevant, 4
Polígono Industrial Llevant
08150 Parets del Vallès
Barcelona - España

Tel. +34 93 571 93 00
www.solerpalau.com



Ref. 9023052700-03

