



CK-60 F



CK-40 F



CK-25 N

Centrifugal extractors manufactured from flame retardant plastic V0. All extractors are class II insulation fitted with centrifugal impeller and single phase 230V-50Hz speed controllable motor. This range consists of three models with airflow ranging up to 625 m³/h.

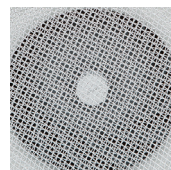

Stainless steel filter

Fitted to the inlet to prevent the build-up of grease within the fan and ducting enclosure (CK-40F and CK-60F).



Protection guard

To avoid any contact with the impeller (CK-25N).

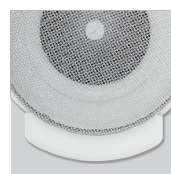

Removable grease collection tray

To collect the grease. Easily removable for cleaning.



CK-60F: 2-speed motor

REGUL-2 speed selector I/II switch to adapt the extract air volume to the needs.



Extractors can be dismantle

Extractor parts easily removable for cleaning in the dishwasher. (At maximum temperature 60°C)

MODEL FEATURES

	CK-25 N	CK-40 F	CK-60 F
GREASE COLLECTION TRAY	●	●	●
PROTECTION GUARD	●		
STAINLESS STEEL FILTER		●	●
REMOVABLE	●	●	●
ADJUSTABLE	●	●	●
2 SPEED			●

TECHNICAL CHARACTERISTICS

Model	Speed (rpm)	Abs. power at free discharge (W)	Voltage (V) 50 Hz	Airflow at free discharge (m³/h)	Sound pressure level* (dB(A))	Weight (kg)	Wiring diagram** (n°)
CK-25 N	2250	40	230	250	50	1,9	11
CK-40 F	2350	70	230	360	55	2,7	11
CK-60 F VR	HS	2475	230	625	59	4,7	9
	LS	1740		415	54		

* Sound pressure level measured at 1,5 m at free air conditions.

** See section of Wiring Diagrams.

DIMENSIONS (mm)

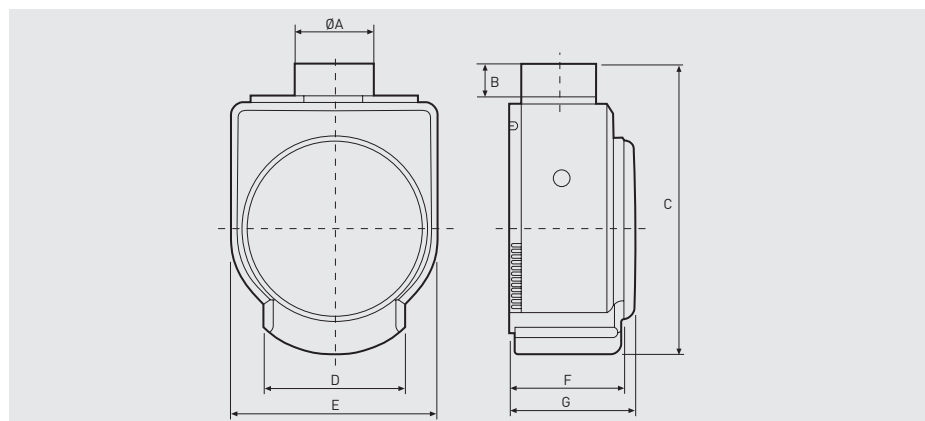

Model	ØA	B	C	D	E	F	G
CK-25 N	98	34	304	149	218	-	127
CK-40 F	98	42	370	179	266	140	162
CK-60 F	116,5	42	410	180	293,5	145	174

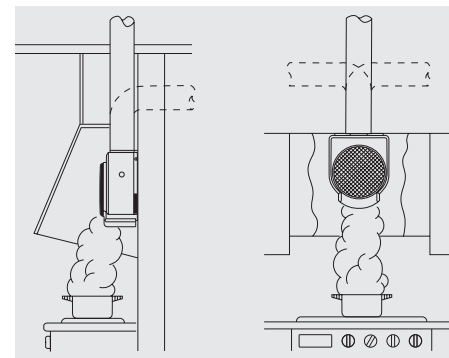

To obtain the maximum efficiency of the polluted air extraction, the K series fans should be installed within a cooker canopy. The airflow required depends upon the canopy width and the distance between the canopy and the cooker. The K series fans should be installed in vertical position with the grease collection tray at the bottom.

PERFORMANCE CURVE

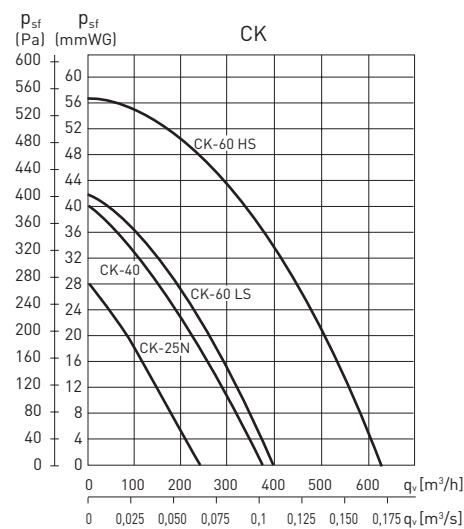

ORIENTATIVE CHART TO CHOOSE THE MOST SUITABLE EXTRACTOR FOR KITCHENS WITH CANOPIES WITHIN THE WALL

CANOPY SIZE	RECOMMENDED AIRFLOW (m³/h)	EXTRACTION DUCT LENGTH *		
		0 to 5 m	5 to 15 m	15 to 30 m
UNTIL 60 cm	200-300	CK-25 N	CK-35 N CK-40 F	CK-40 F CK-50 ECO-500
UNTIL 90 cm	300-600	CK-35 N CK-40 F CK-50 ECO-500	CK-40 F CK-50 ECO-500 CK-60 F	CK-50 ECO-500 CK-60 F

* Expected with an installation with two 90° elbows.

ACCESSORIES

		CK-25 N	CK-40 F	CK-60 F			CK-25 N	CK-40 F	CK-60 F
	GSA Flexible aluminium ducting	GSA-100	GSA-100	GSA-125		GRA Aluminium guards	GRA-75	GRA-75	GRA-100
	CX Worm drive clips	CX-80/125	CX-80/125	CX-125/215		CT Cowl	CT-125	CT-125	CT-125
	PER-W Backdraft shutters	PER-100 W	PER-100 W	PER-125 W		PF-60 Filter panel	PF-60	PF-60	PF-60
	CAR Backdraft shutters	CAR-100	CAR-100	CAR-125		REB Single phase electronic fan speed control regulators	REB-1N REB-1NE	REB-1N REB-1NE	REB-1N REB-1NE
	CM-130 Backdraft shutters			CM-130		REGUL-2 Two speed selector switch			REGUL-2

* For more information see Mounting and Electrical Accessories.

CK KITCHEN EXHAUST FAN KITS

CK PLASTIC RANGE

Are fitted with all the elements (extractor and accessories) needed to carry out a successful installation.



Kit CK-40 F
Includes:
 1 CK-40F fan
 3 m of GSA-100 flexible aluminium ducting
 2 duct connectors CX-80/125
 1 backdraft shutter CM-130



Kit CK-60 F
Includes:
 1 CK-60F fan
 3 m of GSA-125 flexible duct
 2 duct connectors CX-125/215
 1 backdraft shutter CM-130
 1 two speed switch REGUL-2



ECO-500



CK-50



CK-35 N

Centrifugal extractors manufactured from sheet steel with an epoxy polyester paint finished. All extractors are fitted with centrifugal impeller and single phase 230V-50Hz speed controllable motor. This range consists of three models with airflow ranging up to 480 m³/h.



Stainless steel filter

To avoid any contact with the impeller.

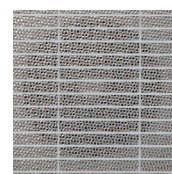

Protection guard

To avoid any contact with the impeller.



Removable grease collection tray

To collect the grease. Easily removable for cleaning.

MODEL FEATURES

	CK-35 N	CK-50	ECO-500
GREASE COLLECTION TRAY	•	•	•
PROTECTION GUARD	•	•	•
STAINLESS STEEL FILTER	•	accessory	accessory
REMOVABLE	•	•	•
ADJUSTABLE		•	•

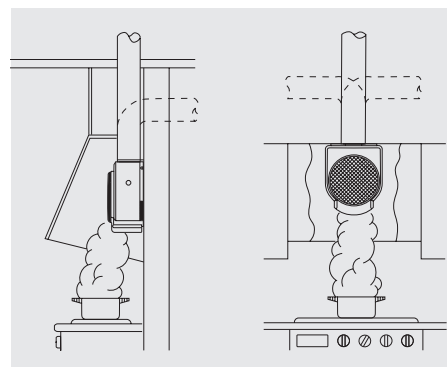

To obtain the maximum efficiency of the polluted air extraction, the K series fans should be installed within a cooker canopy. The airflow required depends upon the canopy width and the distance between the canopy and the cooker. The K series fans should be installed in vertical position with the grease collection tray at the bottom.

TECHNICAL CHARACTERISTICS

Model	Speed (rpm)	Abs. power at free discharge (W)	Voltage (V) 50 Hz	Airflow at free discharge (m ³ /h)	Sound pressure level* (dB(A))	Weight (kg)	Wiring diagram** (n°)
CK-35 N	2200	74	230	350	56	3,2	15
CK-50	1300	120	230	480	58	3,5	15
ECO-500	1370	89	230	385	52	3,5	15

* Sound pressure level measured at 1,5 m at free air conditions.

** See section of Wiring Diagrams.

DIMENSIONS (mm)

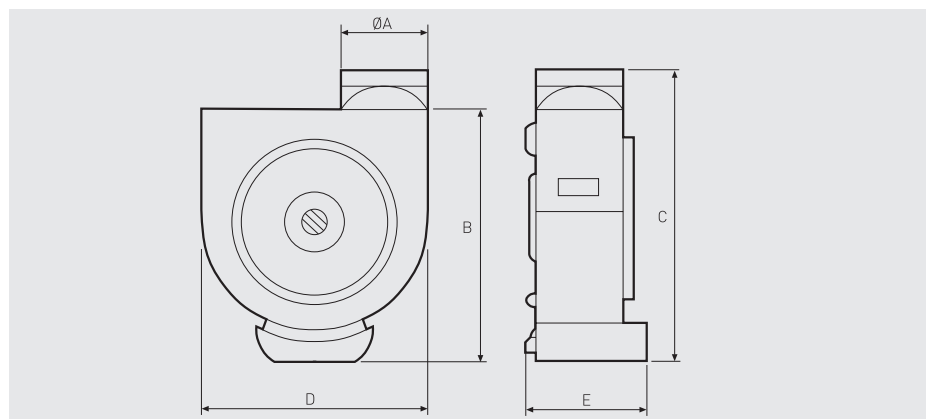

Model	ØA	B	C	D	E
CK-35 N	110	292	337	230	130
CK-50	115	315	375	315	132
ECO-500	115	315	375	315	132

PERFORMANCE CURVE

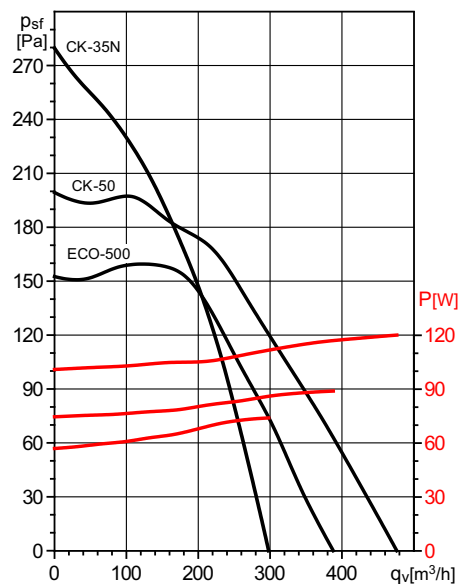

ORIENTATIVE CHART TO CHOOSE THE MOST SUITABLE EXTRACTOR FOR KITCHENS WITH CANOPIES WITHIN THE WALL

CANOPY SIZE	RECOMMENDED AIRFLOW (m ³ /h)	EXTRACTION DUCT LENGTH *		
		0 to 5 m	5 to 15 m	15 to 30 m
UNTIL 60 cm	200-300	CK-25 N	CK-35 N CK-40 F	CK-40 F CK-50 ECO-500
UNTIL 90 cm	300-600	CK-35 N CK-40 F CK-50 ECO-500	CK-40 F CK-50 ECO-500 CK-60 F	CK-50 ECO-500 CK-60 F

* Expected with an installation with two 90° elbows.

ACCESSORIES

		CK-35 N	CK-50	ECO-500			CK-35 N	CK-50	ECO-500
	GSA Flexible aluminium ducting	GSA-125	GSA-125	GSA-125		GRA Aluminium guards	GRA-100	GRA-100	GRA-100
	CX Worm drive clips	CX-125/215	CX-125/215	CX-125/215		CT Cowl	CT-125	CT-125	CT-125
	PER-W Backdraft shutters	PER-125 W	PER-125 W	PER-125 W		PF-60 Filter panel	PF-60	PF-60	PF-60
	CAR Backdraft shutters	CAR-125	CAR-125	CAR-125		REB Single phase electronic fan speed control regulators	REB-1N REB-1NE	REB-1N REB-1NE	REB-1N REB-1NE
	CM-130 Backdraft shutters	CM-130	CM-130	CM-130					

* For more information see Mounting and Electrical Accessories.